

JULY • 1945

# electronics

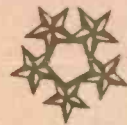

TO THE AMERICAN PEOPLE:

Your sons, husbands and brothers who are standing today upon the battlefronts are fighting for more than victory in war. They are fighting for a new world of freedom and peace.

We, upon whom has been placed the responsibility of leading the American forces, appeal to you with all possible earnestness to invest in War Bonds to the fullest extent of your capacity.

Give us not only the needed implements of war, but the assurance and backing of a united people so necessary to hasten the victory and speed the return of your fighting men.

*William B. Leahy*  
*Dwight D. Eisenhower*  
*Earl King*  
*Walter D. Byrd*  
*W. M. C. Winn*  
*A. M. ...*





# FOR INDUCTORS

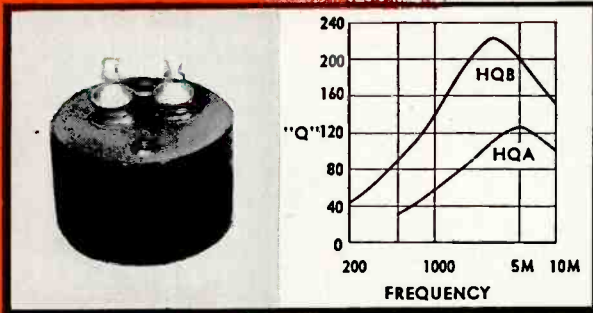

## HQA AND HQB HIGH Q INDUCTORS

This series of toroid wound high stability inductors are available from 5 Mhy. to 2 Hys. Voltage stability is excellent, hum pickup is very low. Temperature effects are negligible. HQA units 1-13/16" in diameter by 1-3/16" high.

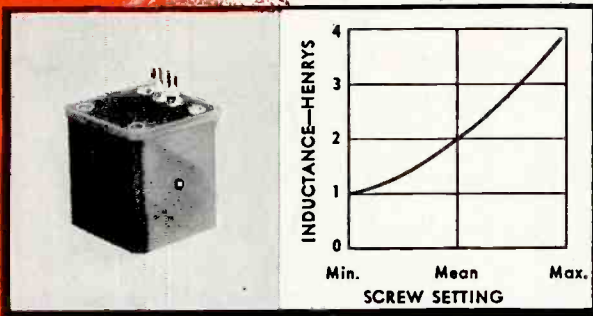

## TYPE VI-C VARIABLE INDUCTORS

These inductors are available in optimum values from 10 Mhy. to 10 Hys. They are tunable over a wide range by inserting an Allen Head wrench in the adjusting screw. Units measure 1 1/4" x 1-7/16" x 1-7/16".

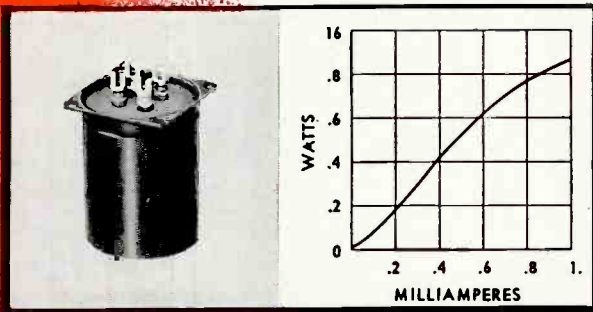

## SENSITIVE SATURABLE INDUCTORS

UTC Saturable Inductors cover a wide range of application for magnetic amplification and control. These units are supplied to specific requirements. The curve shown illustrates a high sensitive type, showing DC saturation vs. AC watts into load.

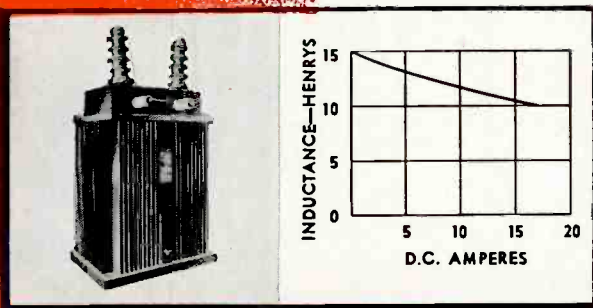

## POWER SUPPLY INDUCTORS

UTC supplies power supply components for every type of application, ranging from a one-third ounce reactor, which measures 3/8" x 7/16" x 3/4", to the 10,000 pound, broadcast station, plate supply reactor, illustrated.

May we cooperate with you on design savings for your applications...war or postwar?

ALL PLANTS



*United Transformer Corp.*

150 VARICK STREET

NEW YORK 13, N. Y.

EXPORT DIVISION: 13 EAST 40th STREET, NEW YORK 16, N. Y.,

CABLES: "ARLAB"

# electronics

A McGRAW-HILL  
PUBLICATION

JULY • 1945

<b>RADIO UNDER FIRE</b> .....		<b>Cover</b>
U. S. Army photo shows how handie-talkie facilitates amphibious landings		
<b>FINAL FCC 25-30,000 Mc ALLOCATIONS</b> .....		<b>92</b>
Assignments proposed in January are made effective, with 44-108 Mc temporarily unassigned		
<b>BROADCAST BAND SATELLITE TRANSMITTERS</b> , by Ross H. Beville .....		<b>94</b>
Unattended boosters fed by r-f line or space radiation can fill in dead spots or extend coverage		
<b>PHOTOTUBE-CONTROLLED FLAME CUTTER</b> , by David S. Walker .....		<b>100</b>
Scanning of small master drums guides oxyacetylene cutting of large steel sheets with high accuracy		
<b>GRID EMISSION IN VACUUM TUBES</b> , by Harold E. Sorg and George A. Becker .....		<b>104</b>
Tests which resulted in the development of a special grid minimizing grid emission		
<b>DUAL-TRIODE TRIGGER CIRCUITS</b> , by Byron E. Phelps .....		<b>110</b>
Non-mathematical step-by-step description of the operation of the Eccles-Jordan circuit		
<b>MEASUREMENT OF STRESSES IN ROTATING SHAFTS</b> , by W. F. Curtis .....		<b>114</b>
Resistance-wire strain gages facilitate vibration analysis and fatigue strength calculations		
<b>MAGNETOSTRICTION COMPASS</b> , by R. G. Rowe .....		<b>123</b>
Electronic compass employing crystal pickups and vibrating magnetostrictive rods		
<b>SUPERSONIC BIAS FOR MAGNETIC RECORDING</b> , by Lynn C. Holmes and Donald L. Clark ..		<b>126</b>
Measurements of the factors governing noise level, linearity and frequency response		
<b>IMPROVED VACUUM-TUBE VOLTMETERS</b> , by J. T. McCarthy .....		<b>137</b>
Methods for increasing power available to operate an indicating instrument		
<b>STABILIZED NEGATIVE IMPEDANCES, PART I</b> , by E. L. Ginzton .....		<b>140</b>
First of a three-part article on theory and application of negative impedances		
<b>CROSSTALK</b> .....	<b>91</b>	
<b>INDUSTRIAL CONTROL</b> .....	<b>152</b>	
<b>TUBES AT WORK</b> .....	<b>208</b>	
<b>ELECTRON ART</b> .....	<b>250</b>	
<b>NEWS OF THE INDUSTRY</b> .....	<b>290</b>	
<b>NEW PRODUCTS</b> .....	<b>346</b>	
<b>NEW BOOKS</b> .....		<b>394</b>
<b>BACKTALK</b> .....		<b>400</b>
<b>INDEX TO ADVERTISERS</b> .....		<b>411</b>

**KEITH HENNEY**, Editor; **W. W. MacDonald**, Managing Editor; **John Markus**, Associate Editor; **Vin Zeluff**, Associate Editor; **Assistant Editors**—**Frank Haylock**, **Frank Rockett**, **J. M. Heron**, **M. L. Matthey**, and **J. E. Grolmund**; **G. T. Montgomery**, Washington Editor; **Donald G. Fink** (on leave); **Harry Phillips**, Art Director

**H. W. MATEER**, Publisher; **J. E. Blackburn, Jr.**, Director of Circulation, Electronics; **Wallace B. Blood**, Manager

**DISTRICT MANAGERS**, **D. H. Miller**, **H. R. Denmead, Jr.**, New York; **R. H. Flynn**, New England; **F. P. Coyle**, **R. E. Miller**, Philadelphia; **C. D. Wardner**, **A. F. Tischer**, **R. A. Werth**, Chicago; **E. J. Smith**, **J. L. Phillips**, Cleveland

CONTENTS COPYRIGHT, 1945, BY McGRAW-HILL PUBLISHING COMPANY, INC.  
 McGRAW-HILL PUBLISHING COMPANY, INCORPORATED  
 JAMES H. McGRAW, Founder and Honorary Chairman  
 PUBLICATION OFFICE 99-129 North Broadway, Albany 1, N. Y., U. S. A.  
 EDITORIAL AND EXECUTIVE OFFICES 330 West 42nd St., New York 18, N. Y., U. S. A.

James H. McGraw, Jr., President; Curtis W. McGraw, Senior Vice-President and Treasurer; Howard Ehrlich, Vice-President (for business operations); John Abbink, Vice-President (for editorial operations); Joseph A. Gerardi, Secretary; and J. E. Blackburn, Jr., Director of Circulation.

**ELECTRONICS**, July, 1945, Vol. 18; No. 7. Published monthly, price 50¢ a copy, June Directory Issue \$1.00. Allow at least 10 days for change of address. All communications about subscriptions should be addressed to the Director of Circulation, 330 W. 42nd St., New York 18, N. Y.

Subscription rates—United States and possessions, Mexico, Central and South American countries, \$5.00 a

year, \$8.00 for two years, \$10 for three years. Canada (Canadian funds accepted) \$5.50 a year, \$9.00 for two years, \$11.00 for three years. Great Britain and British Possessions, 42 shillings for one year, 84 shillings for three years. All other countries \$7.00 for one year, \$14.00 for three years. Please indicate position and company connection on all subscription orders. Entered as Second Class matter August 29, 1936, at Post Office, Albany, New York, under the Act of March 3, 1879. BRANCH OFFICES: 520 North Michigan Avenue, Chicago 11, Ill.; 68 Post Street, San Francisco 4; Aldwych House, Aldwych, London, W.C. 2; Washington, D. C. 4; Philadelphia 2; Cleveland 15; Detroit 26; St. Louis 8; Boston 16; Atlanta 3, Ga.; 821 So. Hope St., Los Angeles 14; 38-9 Oliver Building, Pittsburgh 22.

## CHANGE OF ADDRESS

Director of Circulation,  
**ELECTRONICS**,  
 330 West 42nd Street  
 New York 18, N. Y.

Please change the address of my Electronics subscription.

Name .....

Old Address .....

New Address .....

New Company Connection .....

New Title or Position .....

# Weigh the Advantages

## of MOLDED OIL PAPER CAPACITORS



### NOTE THESE FACTS

Molded oil-paper capacitors, first used as a "make-shift" for mica units, have now earned a place of their own in electronics—meriting their serious consideration in new product designs. With greater capacitance in any case size, properly processed molded paper capacitors have extremely low series resistance and can carry relatively large R.F. currents. Their high shunt resistance, maintained thru the moisture-proof sealing of all units, suits them to A.F. applications at all usual plate voltages.

CAPACITANCES: 1000 to 50000 mmfd.  
 WORKING VOLTAGES: 125 to 800 v.d.c.  
 SIZES: CN20 and CN35



FIELD OFFICES IN NEW YORK CITY • CHICAGO • DETROIT • GLENDALE, CALIFORNIA



# Not afraid of GHOSTS

## Phoenix

REG. U. S. PAT. OFF.

### TRACING CLOTH

IT'S moisture-proofing that makes PHOENIX Tracing Cloth resist damp hands and arms. It will even stand up to ten minutes immersion in water. That's why it's proof against moisture ghosts — the ghosts that haunt prints made from tracing cloths that show perspiration stains.

Besides, PHOENIX is smudge ghost-proof. You can use harder pencils and still get solid, opaque lines. They'll smudge less.

And erasure ghost-proof too. Erasing leaves less scars on PHOENIX. Redrawn pencil lines are smooth. Ink won't feather.

For the full story and a sample, write on your letterhead to Keuffel & Esser Co., Hoboken, N. J.



## KEUFFEL & ESSER CO.

EST. 1867

*Drafting, Reproduction, Surveying Equipment  
and Materials. Slide Rules. Measuring Tapes.*



CHICAGO • NEW YORK • HOBOKEN • DETROIT  
ST. LOUIS • SAN FRANCISCO • LOS ANGELES • MONTREAL

# MAINTAINING PRODUCT PERFORMANCE

## TOMORROW...



**MUNSELL** MICA  
**MICANITE** Built-Up Mica  
**LAMICOID** Laminated Plastics  
**EMPIRE** Varnished Cloths and Tapes  
**MICO** Insulating Semiconductors  
**MICA**

**HIGH DIELECTRIC STRENGTH** in minimum space is obtained with this three mil bias-cut varnished-rayon. It lays smoothly on the curved parts of this magneto coil made by Fairbanks, Morse & Co. Empire 3-mil seamless bias-cut tape is also used for this type of application.

**MECHANICAL LAMICOID** offers high mechanical strength, dimensional stability, and resistance to moisture and shock. Strong, dense and non-hydroscopic, it is easily punched, sheared, sawed or machined into intricate shapes.

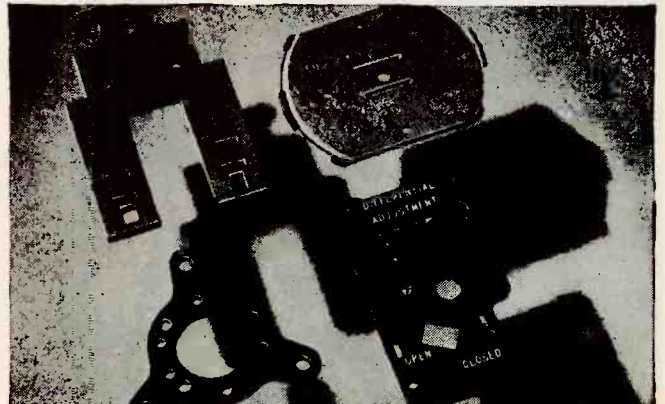
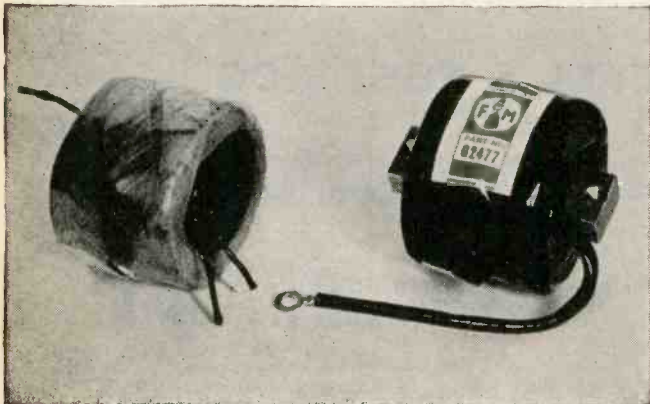

# DEPENDS ON INSULATION DECISIONS

# TODAY!

Product engineers can build future performance into all of their products by anticipating and eliminating every possible cause of insulation failure. That is why many manufacturers engaged in designing new and improved electrical and electronic products are consulting Mica Insulator Company. Insulation standards may be revised to incorporate wartime insulation developments, techniques and improved materials.

Insulation standards that assure dependable product performance are determined by economic conditions, temperature rise limits, and physical factors, likely to be encountered by the product under unusual or extreme service conditions. For example, the electrical strength of insulation may be greatly affected by mechanical disintegration. Deterioration by dirt, moisture or chemicals; mechanical

stresses or physical support; intermittent use and variable loading; atmospheric conditions; and many other factors influence the selection of the proper type and class of insulation material for a specific application.

By consulting Mica Insulator Company early in your design planning, you can obtain recommendations for the use of new materials, techniques—and you secure expert diagnosis that correlates all factors that'll do much to keep your product out in front of future competition.

## SALES OFFICES:

BOSTON • CINCINNATI • CHICAGO • CLEVELAND • DETROIT  
HOUSTON • LOS ANGELES • NEW YORK • SAN FRANCISCO • SEATTLE

## FACTORY:

SCHENECTADY, NEW YORK

# Insulator COMPANY

200 Varick Street  
New York 14, N. Y.

**HIGH SAFETY FACTOR** for high temperatures, humidity, and heavy overloads is assured with Fiberglas and mica insulation in this rotor for a motor generator.



No matter how small or large your insulation problem may be, you will always find our Field Engineer ready to help find a solution. You can obtain the benefit of his many years of specialized insulation experience at no extra cost.

Mica Insulator Company,  
200 Varick Street, New York 14, New York

CLIP TO YOUR  
COMPANY LETTERHEAD  
AND MAIL TODAY

Gentlemen:

- I have an insulation problem to discuss with your Field Engineer when he is in my vicinity.
- I would like your free, 27-page catalog "Electrical Insulating Materials," which contains valuable application data.

Name \_\_\_\_\_

Title \_\_\_\_\_

Firm Name \_\_\_\_\_

Address \_\_\_\_\_

# "CQ..."

*we'll hear it  
again—SOON*

**THE HAM IS  
COMING BACK...  
STRONGER THAN EVER**

## Who Said The "Ham" Is Finished?

THERE have been rumors to the effect that the radio Amateurs were going to be denied their old frequency bands, and given new bands of such high frequency as to be useless for medium and long distance communication.

Some rumors say "Remember the last War? We are going to get the same treatment this time!"

Now, we don't believe the "Hams" should be denied their rightful place on the air in bands suitable for communication beyond the horizon—and further, we do not believe that our Government would want to see those privileges denied.

Are not the "Hams" fighting on many battlefronts, working in war factories and laboratories for a New World wherein the individual will be able to live and enjoy his hobbies, his church, and other personal freedoms which go to make up a healthy, happy world?

It is well-known among Government officials whose task it was to build our great war-time communications system that from the rank and file of amateurs came executives, instructors and thousands of engineers and operators. Without this nucleus of experienced men, it would no doubt have taken a much longer time to reach the present high degree of perfection in the communications branch of our fighting forces.

In every emergency Amateurs have proved their ability and willingness to come to the aid of their Country—and would be so unjust as to want to deny them their small place in the radio spectrum? We do not believe these rumors that the "Ham" will be denied his privileges, we believe rather that those who speak so much of justice coming out of this war will see to it that the Amateur receives his just reward.

The entire radio industry knows well, and appreciates the many contributions "Hams" have made for the advancement of high frequency radio communications, and surely they too can be counted on to assist the "Ham" in regaining his privileges when the right time comes.

HAMMARLUND MANUFACTURING CO., Inc.  
460 West 34th Street, New York 1, N. Y.

THIS AD APPEARED IN MARCH, 1944

WE never lost faith in the friends of amateur radio. We believe progress up to this very moment indicates that Hams have many friends in high places. Of course, there is a lot of romance to Ham radio, but the place won by the Ham in the hearts and minds of important people is the result of a very practical demonstration of real worth—real American ability.

We wish to openly express our sincere appreciation for the wisdom of those whose job it was to guide amateur radio through these troubled times. And those who have given Hams a just portion of the spectrum are to be commended for their farsightedness.

American amateurs can be thankful they live in a country where ability receives its just reward.

LLOYD A. HAMMARLUND, President

**HAMMARLUND MFG. CO., INC., 460 W. 34th ST., NEW YORK 1, N. Y.**



# Why AMPEREX

WATER AND AIR COOLED  
TRANSMITTING AND RECTIFYING TUBES

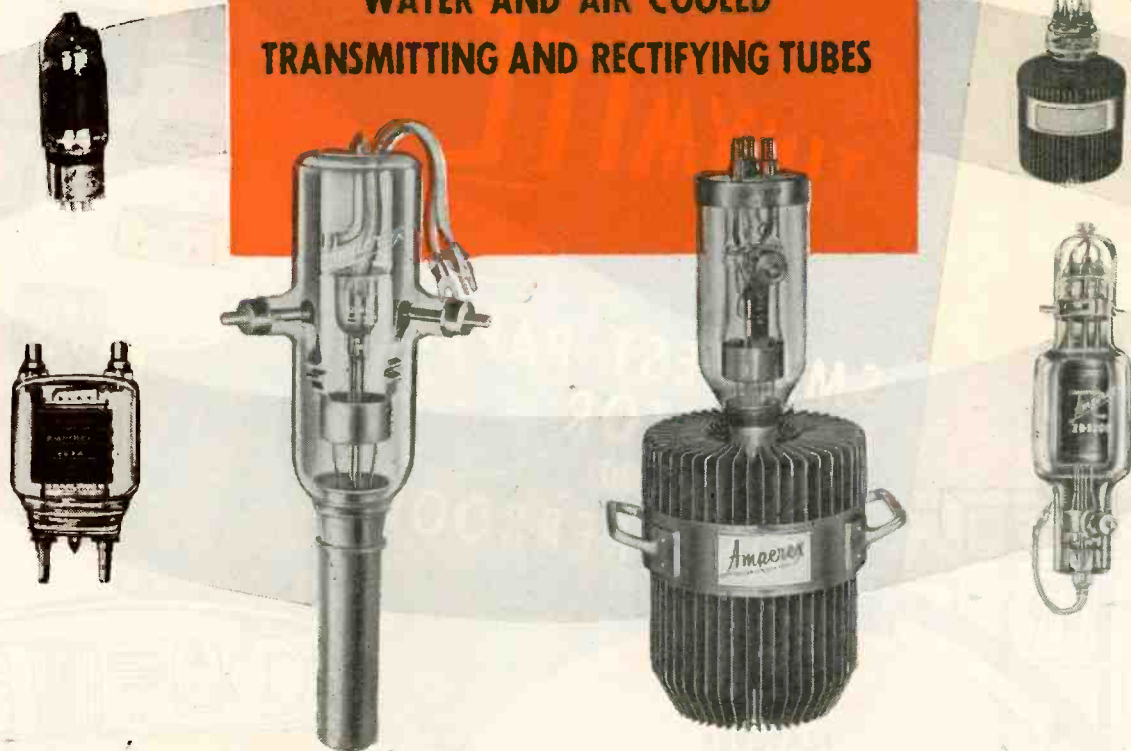

Colloquially speaking, we of *Amperex* have "broken our necks" to provide dependable service to our customers during these war years. This statement, we feel sure, will be supported by those who have made us their source of tube supply. Important to note is that the "Amperextra" of dependable service has been matched by the "Amperextra" of dependable quality. In commercial broadcasting — AM, FM, Television — in electro-medical apparatus, in communications systems, in industrial applications, *Amperex* tubes have delivered and still are delivering high efficiency over a longer period of time. The *Amperex* Application Engineering Department, another "Amperextra", will be glad to work with you on present or postwar problems. *This is Service.*

*Many of our standard tube types are now available through leading radio equipment distributors.*



## AMPEREX ELECTRONIC CORPORATION

25 Washington St., Brooklyn 1, N. Y., Export Division: 13 E. 40th St., New York 16, N. Y., Cables: "Arlab"

Canadian Distributor: Rogers Electronic Tubes, Limited • 622 Fleet Street West, Toronto

WASTEPAPER IS VITAL WAR EQUIPMENT... SAVE EVERY SCRAP

Where **SPACE** and  
**PERFORMANCE** are Vital  
DUMONT OFFERS . . . .

*The*  
**TINYMITE**

**SMALLEST PAPER  
CAPACITOR . . . .**  
yet 100%  
**MOISTUREPROOF**

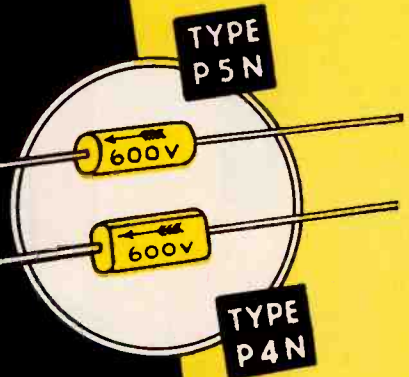

CLOCK  
RADIO

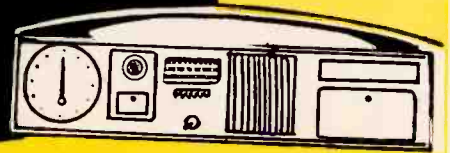

AUTO RADIOS

**FEATURES**

1. Bakelite Resinoid Ends. Lead wire cannot pull out, even under hot conditions.
2. Non-Inductive.
3. Excellent Temperature Coefficient.
4. Very high leakage Resistance.
5. Fine Power-Factor.
6. Range from 20 MMFD to .25 MFD. From 150 volts to 600 volts.
7. Types P4N, P5N for 100% humidity operation.
8. Types P4, P5 for 95% humidity operation.

*Samples and price list on request*

PAT.  
PEND.



HEARING  
AIDS

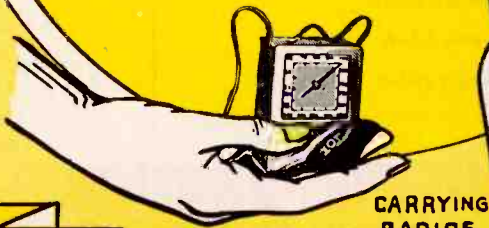

CARRYING  
RADIOS

**DUMONT  
ELECTRIC CO.**  
MFRS OF  
CAPACITORS FOR EVERY REQUIREMENT  
34 HUBERT STREET NEW YORK, N. Y.

BUY EXTRA WAR BONDS . . . . 'TILL THE WAR IS OVER

# SALT WATER MIKES

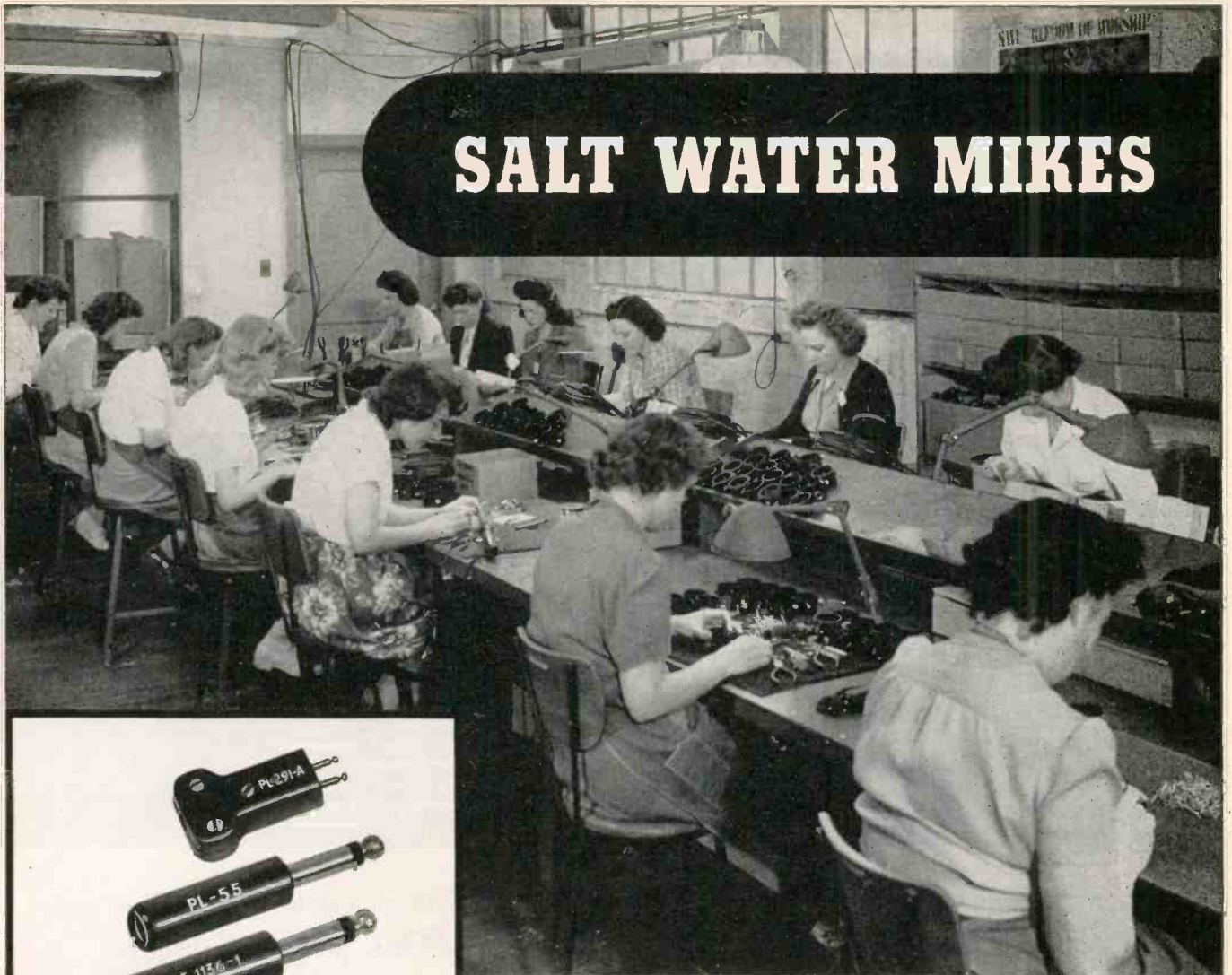

Marine microphone assembly. Plastic and metal parts designed, made and assembled by Remler to meet Navy and Merchant Marine specifications.



## PLUGS & CONNECTORS

Signal Corps • Navy Specifications

Types:		PL			NAF	
50-A	61	74	114	150		
54	62	76	119	159		
55	63	77	120	160		1136-1
56	64	104	124	291-A		
58	65	108	125	354		No.
59	67	109	127			212938-1
60	68	112	149			

PLP		PLQ		PLS	
56	65	56	65	56	64
59	67	59	67	59	65
60	74	60	74	60	74
61	76	61	76	61	76
62	77	62	77	62	77
63	104	63	104	63	104
64		64			

OTHER DESIGNS TO ORDER

**ONE REMLER ASSIGNMENT** is the production of amplifying and transmitting systems for our Navy and Merchant Marine. Systems are complete—from shock-proof microphones, built to resist the corrosive action of salt air and water to transmitters and bull-horn speakers for baby Flat Tops. • Remler was organized in 1918 to manufacture ship wireless. Present activities in marine communications are a logical development of early activities in this field. The facilities and experience of this organization are at your disposal.

Further assignments in radio and electronics invited. Consult—

REMLER COMPANY, LTD. • 2101 Bryant St. • San Francisco, 10, Calif.

# REMLER

SINCE 1918

Announcing & Communication Equipment

# PROBLEMS ARE OUR DISH—

*Try your Know-How on this one!*

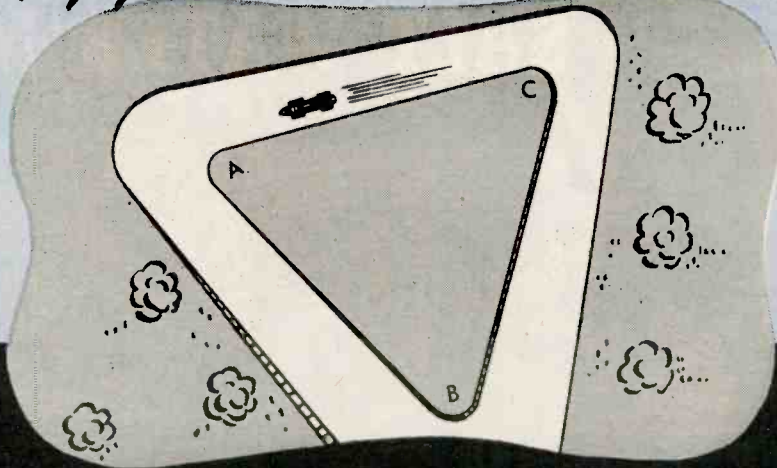

The Duke of Franklin marked out a race course, making the distance from A to B the same as the distance from B to C and that from C back to A. He made the circuit, going three times as fast from B to C as he did from A to B. From C to A he travelled twice as fast as he did from B to C. His average speed over the entire course was 50 miles an hour. What were his speeds on each of the three sides?

The answer to this one will be given in next month's advertisement or in reply to your written query. But don't give up, it's simple to solve as is our ability to solve your design, fabricating, production and assembly problems.

At Franklin you will find engineers with the Know-How of design and the What-With in equipment and facilities for coordinated efficient production . . . tool and die makers who click the first time . . . facilities for compression molding of bakelite parts . . . equipment for making plastic parts including laminations . . . machinery for fabricating small metal parts . . . hot tinning . . . plating . . . parkerizing . . . vacuum impregnating . . . tropicalization . . . all the facilities to do a job from the raw material to the finished part and complete assembly.

Franklin coordinated engineering, design, fabrication and production assures economical use of materials, low competitive costs and quick certain deliveries . . . let Franklin solve your production problems.

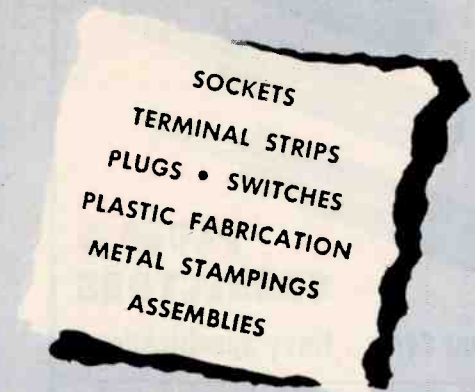

## LAST MONTH'S PROBLEM AND ITS SOLUTION

**Problem**—A rope ladder ten feet long is hanging over the side of a ship. The rungs are a foot apart. The bottom rung is resting on the surface of the ocean. The tide rises at the rate of six inches an hour—when will the first three rungs be covered with water, and why?

**Solution**—Never. The ladder and ship will rise with the tide. Embarrassing, eh what?



# A.W. FRANKLIN

**MANUFACTURING CORP.**  
175 VARICK ST., NEW YORK 14, N. Y.

SOCKETS • TERMINAL STRIPS • PLUGS • SWITCHES • PLASTIC FABRICATION • METAL STAMPINGS • ASSEMBLIES



# Famous Lighthouse Tubes

Disk-seal  
parallel-plane  
design

●  
For use in the  
ultra-high-  
frequency  
spectrum



TYPE 2C40  
RECEIVING TUBE



TYPE 6L3C22  
TRANSMITTING TUBE

## Basic Ratings

For complete information on G-E lighthouse tubes and the story of their development, ask for Bulletin ETR-7, "The Lighthouse Tube".

	TYPE 2C40 (as local oscillator)	TYPE 6L3C22 (as power oscillator)
Filament voltage	6.3 v	6.3 v
Filament current	0.75 amp	2 amp
Max plate voltage	500 v	1,000 v
Max plate current	25 ma	150 ma
Max plate dissipation	6.5 w	125 w
Plate power output, typical operation	.075 w	50 w (at 600 mc)

● Developed by G-E engineers, the new Lighthouse Tubes have extended the top frequency limits, making possible outstanding performance in FM broadcasting, television, aviation and marine radio, and other fields. See your nearest G-E office or distributor, or write to *Electronics Department, General Electric, Schenectady 5, N. Y.*

# GENERAL ELECTRIC

161-D7-8850

TRANSMITTING, RECEIVING, INDUSTRIAL, SPECIAL PURPOSE  
TUBES • VACUUM SWITCHES AND CAPACITORS



# AM

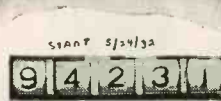
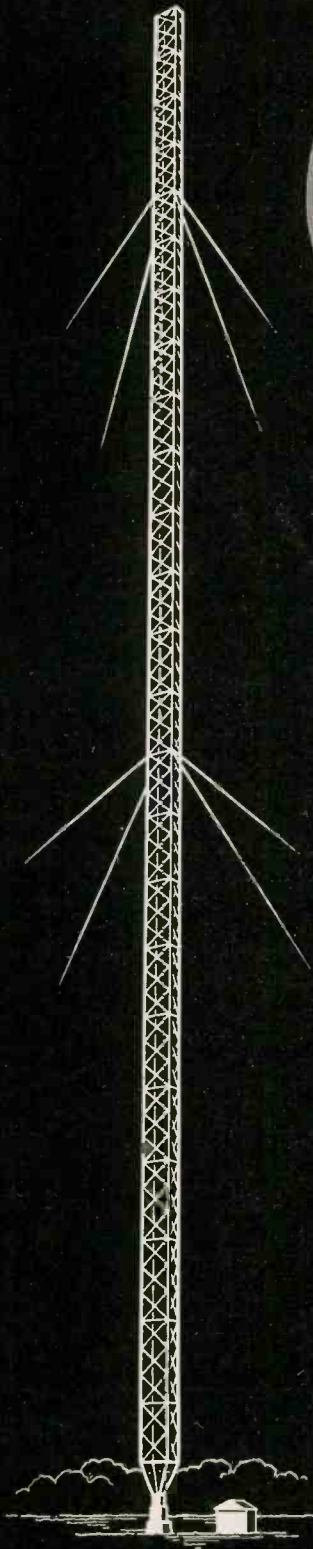

20,000	7/1/35
30,000	8/8/36
40,000	12/16/37
50,000	5-9-38
60,000	9-14-39
70,000	1-18-42
80,000	5-20-43
90,000	4-4-44

HOURS

GENERAL  ELECTRIC

← This hour meter on the G-E 50,000-watt AM transmitter at WGY has clicked off more than 94,000 hours of "on-the air" operation in 18 years of daily service.

G-E 50,000-watt award-winning AM transmitter at WGY, Schenectady, N. Y.

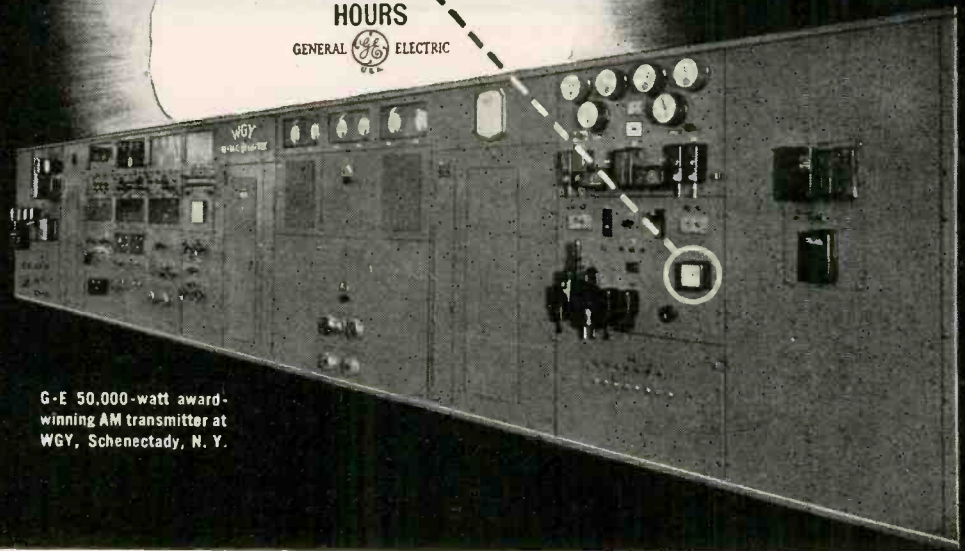

STUDIO AND STATION EQUIPMENT • TRANSMITTERS

# GENERAL ELECTRIC

160-D4-8914

- Award presented to NBC's affiliated AM station WGY for having the most nearly perfect operation record in 1944. WGY holds a similar award for 1936.



# Wins top honors

## Again, a G-E AM transmitter wins the NBC network award for the most perfect operating record.

OFF the air but 52 seconds in 6947 hours of program time during 1944, General Electric's 50,000-watt AM transmitter wins for WGY in Schenectady the NBC network award for greatest broadcast service in terms of solid hours of program delivery—the second time since 1936!

With a record of more than 94,000 hours of operation to its credit during thirteen years of daily service, this transmitter is typical of all G-E AM broadcast transmitters—transmitters that are famous for lower equipment cost per hour of broadcast service. This is the kind of performance that has built advertiser confidence. And this is the kind of reliability you can count on getting in your new G-E broadcast equipment—whether it is AM, Television, or FM. General Electric AM transmitters are built on a rich background of research and development, both in radio and in every line of electrical equipment. For more than thirty years, G. E. has been designing and making the most advanced and reliable broadcast apparatus in the world. During this



time, General Electric manufactured many of the first high-power AM transmitters and all of America's 100-kw international transmitters. Today, G.E. operates its own AM broadcast proving-ground in Schenectady where seven big AM, FM, television, and international stations are on the air.

Whether your AM requirements are for standard band or international service, General Electric will supply everything for your needs—AM transmitters ranging in power from 250 watts to 1,000 kilowatts, complete studio equipment, auxiliary electrical components, entire antenna systems. G-E equipment will include all the refinements of modern AM transmitter design—with new basic improvements in modulation quality, frequency response, and low noise level. G-E AM equipment will be simplified, easy to control and to maintain, economical to operate. For further information on General Electric's AM broadcast equipment, see your G-E sales representative, or write: Electronics Department, General Electric, Schenectady 5, N. Y.

**Establish a priority on delivery of your AM equipment.** Write for your copy of the "G-E Equipment Reservation Plan" which explains General Electric's plan to help you obtain early delivery of AM transmitters and associated equipment.

**Use G-E Electronic Tubes in your station for maximum dependability and finer performance.**

ANTENNAS • ELECTRONIC TUBES • HOME RECEIVERS

FM • TELEVISION • AM

*See G.E. for all three!*

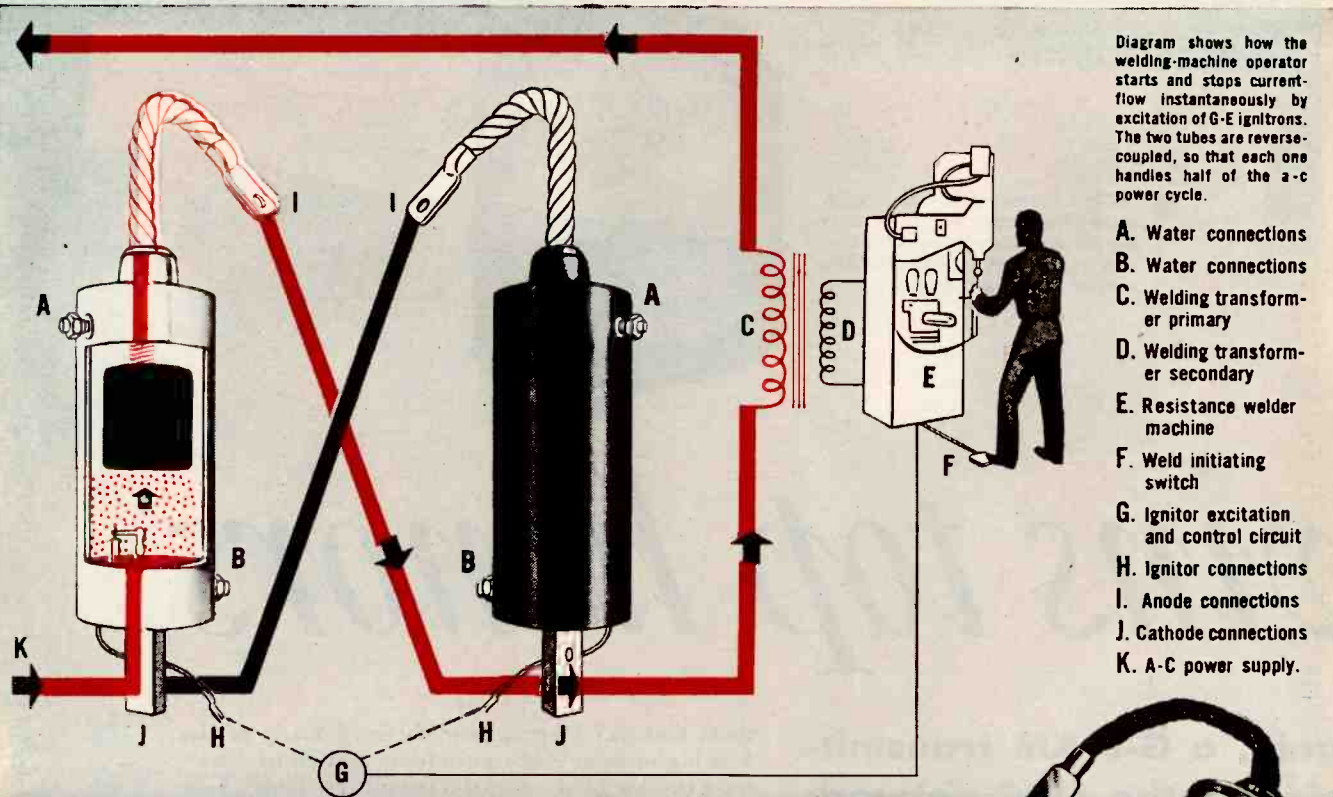

Diagram shows how the welding-machine operator starts and stops current-flow instantaneously by excitation of G-E ignitrons. The two tubes are reverse-coupled, so that each one handles half of the a-c power cycle.

- A. Water connections
- B. Water connections
- C. Welding transformer primary
- D. Welding transformer secondary
- E. Resistance welder machine
- F. Weld initiating switch
- G. Ignitor excitation and control circuit
- H. Ignitor connections
- I. Anode connections
- J. Cathode connections
- K. A-C power supply.



# IGNITRONS "trigger" the heavy currents for resistance welding



**A**N important use of G-E ignitron tubes is shown above—controlling the primary current of resistance welders. The same benefits of split-second, positive "valve" action, with no mechanical linkage and no arcing between movable contacts, are provided by G-E ignitrons for other control circuits—furnace, motor, etc.—involving heavy electrical currents.

- Current control is but one of this tube's functions in industry. Another is current conversion—a-c to d-c. Here ignitrons offer the advantages of silent operation, no rotating parts, no need for lubrication, no mechanical upkeep.
- Steel-jacket construction and mercury-pool type cathode, among other

features, make the G-E ignitron sturdy, dependable, and long-lived. Learn more about this versatile electronic tube from G.E.'s new Booklet ETI-21, "Ignitron Tubes and How They Are Used." Its 24 profusely illustrated pages, complete with selected circuits, tell the full story of ignitrons and how they serve industrially. Your free copy is waiting. Telephone TODAY your nearest G-E office or distributor, or write to *Electronics Department, General Electric, Schenectady 5, N. Y.*

Hear the G-E radio programs: "The World Today" news, Monday through Friday, 6:45 p. m., EWT, CBS. "The G-E All-Girl Orchestra," Sunday 10 p. m., EWT, NBC. "The G-E House Party," Monday through Friday, 4 p. m., EWT, CBS.

## IGNITRON FG-235-A . . . \$75.

This tube is one of the most widely used G-E ignitrons. It is a steel-jacketed, water-cooled, gas-filled triode with mercury-pool cathode, used for welder and other heavy current controls, and as a low-power current converter. For welder-control service, ratings are: max kva demand 1,200, with corresponding avg anode current 75.6 amp—max avg anode current 140 amp, with corresponding kva demand 400. (These ratings are for voltages of 600 v rms and below.) Ignitron requirements are 200 v and 30 amp. . . . Ratings for current conversion will be supplied on request, in which case please include a brief description of the application or circuit.

G.E. HAS MADE MORE BASIC ELECTRONIC TUBE DEVELOPMENTS THAN ANY OTHER MANUFACTURER

# GENERAL ELECTRIC

162-D12-6650

TRANSMITTING, RECEIVING, INDUSTRIAL, SPECIAL PURPOSE TUBES ★ VACUUM SWITCHES AND CAPACITORS



# IF YOU HAVE A "FITTINGS" PROBLEM



# AMPHENOL

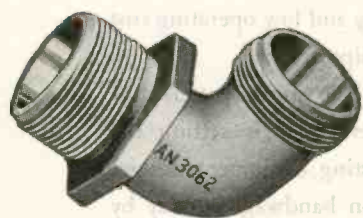

The comprehensive Amphenol line of "AN" Conduit Fittings is made to strict Army and Navy standards. Threads are accurately manufactured to specification, so that parts are completely interchangeable. Permaluk coating on threads prevents binding of the coupled parts . . . obtainable in eleven finishes.

Amphenol Fittings have widespread uses in the radio, communications and electrical industries.

Amphenol Fittings are another precision made unit in the complete Amphenol line of U.H.F. Cables and Connectors, Conduit, Connectors (A-N., U.H.F. British), Cable Assemblies, Radio Parts and Plastics for Industry.

Amphenol Condensed Catalog number 72 is now ready . . . write for your copy today.

Depend upon Amphenol Quality.



**AMERICAN PHENOLIC CORPORATION**  
Chicago 50, Illinois  
In Canada • Amphenol Limited • Toronto

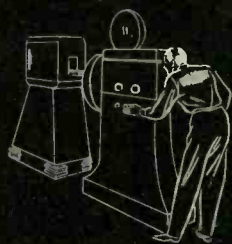

DuMont Projector and Film Pickup Camera



Master Control Board



DuMont-equipped Television Truck



Producer's Control Desk

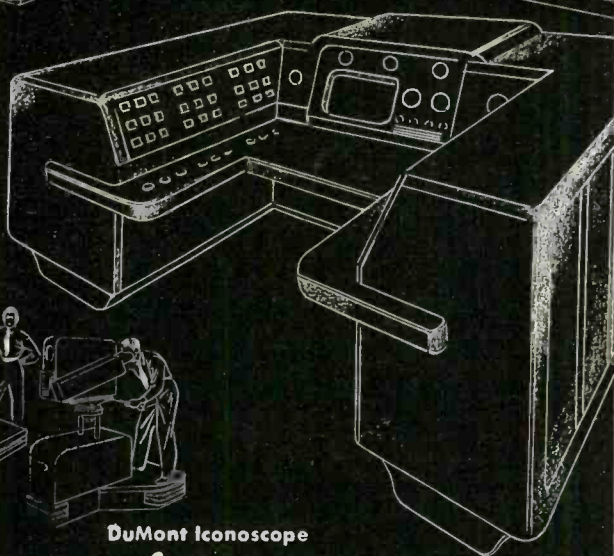

### DuMONT TRANSMITTER CONTROL CONSOLE and DuMONT VIDEO-AUDIO TRANSMITTER

Only the DuMont Transmitter Console offers *all* these features:

1. 12" cathode-ray tube for observing picture quality.
2. Control buttons for individual transmitter stages.
3. Necessary meters for constant checks on operation.
4. Cathode-ray oscillographs for observing signals and individual stage operation.
5. Patch-in rack for checking individual stages and signal off the air.
6. Automatic and manual safety switches for emergencies.
7. Synchronized electric clock for time recording.
8. Automatic time recorder.
9. Intercommunication system microphone and loudspeaker.
10. Facilities for logbook and other records.

DuMont Sound Boom



DuMont Iconoscope Camera

## DuMONT—FOR THE TOOLS OF TELEVISION

Simplified precision control is the design keynote of all DuMont Television Broadcasting Equipment. Typical of this bull's-eye concentration on basic essentials is the DuMont Transmitter Control Console. All meters and controls of the Video-Audio Transmitter are combined with the station monitor (formerly a separate unit) to achieve a new standard in safety, easy visibility and centralized operation. Operators can be quickly trained to attend it.

DuMont has equipped *more* television stations than any other company. Week-in, week-out, these

stations are demonstrating the high pickup and transmitting quality and efficiency, the extreme flexibility, rugged dependability and low operating cost of DuMont-engineered equipment.

DuMont has pioneered the profit pattern for peacetime commercial television... is setting the pace in television broadcasting equipment design. Climb aboard the television bandwagon today by using the DuMont Equipment Reservation Plan to insure early delivery of equipment and training of personnel. *Ride with the leader!*

Copyright 1945, Allen B. DuMont Laboratories, Inc.

# DUMONT



*Precision Electronics and Television*

ALLEN B. DUMONT LABORATORIES, INC., GENERAL OFFICES AND PLANT, 2 MAIN AVENUE, PASSAIC, N. J. TELEVISION STUDIOS AND STATION WABD, 515 MADISON AVENUE, NEW YORK 22, NEW YORK

# COMPLETE LIST OF ALL **dag** DISPERSIONS NOW AVAILABLE! New Products Listed

A number of new dispersions, developed for war uses by Acheson Colloids Corporation, are presented for the first time in a new bulletin (440). Other members of the versatile **dag** family of colloidal and semi-colloidal graphite products are also described.



Even though you now use **dag** colloidal graphite, it will pay you to get this complete list. New applications, even more valuable than those you now employ, may suggest themselves to you when you review the wide range of products in the **dag** line. If you have problems which **dag** colloidal graphite may be

able to solve, the Acheson Colloids' experienced technical staff is ready to help you without obligation. Send complete data, samples, blue prints, charts etc., or ask to have a Service Engineer visit your plant. Other free literature on specific applications for **dag** colloidal graphite is ready. See below.



## **dag** colloidal graphite

ACHESON COLLOIDS CORPORATION, Port Huron, Michigan

### TO GET THESE:

This new literature on "**dag**" colloidal graphite is yours for the asking:

- 430** A general booklet on the story of "**dag**" colloidal graphite. 12 pages profusely illustrated.
- 440** A complete list of "**dag**" colloidal graphite dispersions with applications.
- 421** "**dag**" colloidal graphite for ASSEMBLING AND RUNNING-IN ENGINES AND MACHINERY.
- 422** "**dag**" colloidal graphite as a PARTING COMPOUND.
- 423** "**dag**" colloidal graphite as a HIGH TEMPERATURE LUBRICANT.
- 431** "**dag**" colloidal graphite for IMPREGNATION AND SURFACE COATINGS.
- 432** "**dag**" colloidal graphite in the FIELD OF ELECTRONICS.

### MAIL THIS:

JML Co. A-F

ACHESON COLLOIDS CORPORATION, PORT HURON, MICHIGAN DEPT. 5-G

Please send me, without obligation, your new bulletin No. 440 on **dag** colloidal graphite, and also free copies of the specific bulletins checked below.

- No. 430  NAME \_\_\_\_\_
- No. 440  POSITION \_\_\_\_\_
- No. 421  FIRM \_\_\_\_\_
- No. 422  ADDRESS \_\_\_\_\_
- No. 423  ZONE No. \_\_\_\_\_ STATE \_\_\_\_\_
- No. 431  OUR PRESENT OIL SUPPLIER IS \_\_\_\_\_
- No. 432  (Lubricants containing **dag** colloidal graphite are available from major oil companies.)

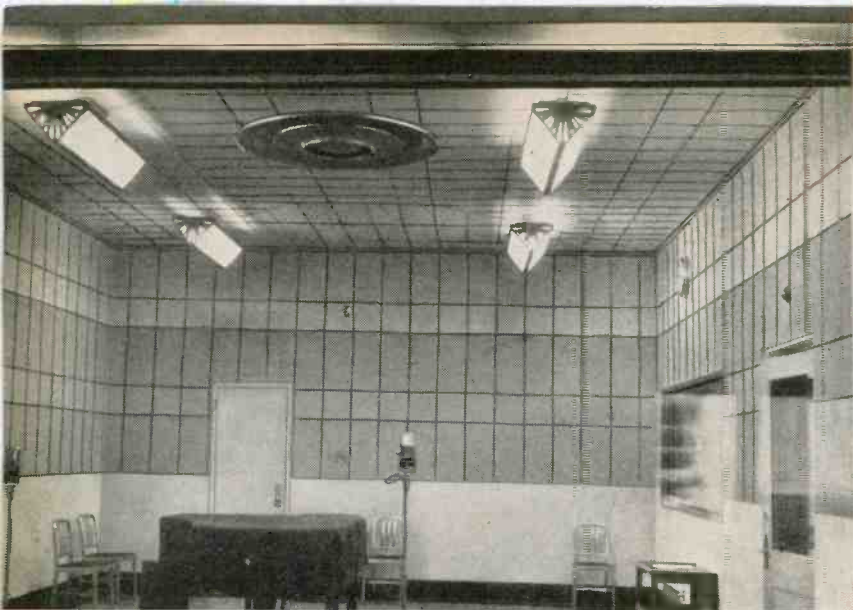

One of the studios used interchangeably by FM station WBRL and AM station WJBO. RCA-Type 44-BX Microphones are used in this studio, in the smaller announce-type studio, and in the large, auditorium-type studio.

# FM Equipment

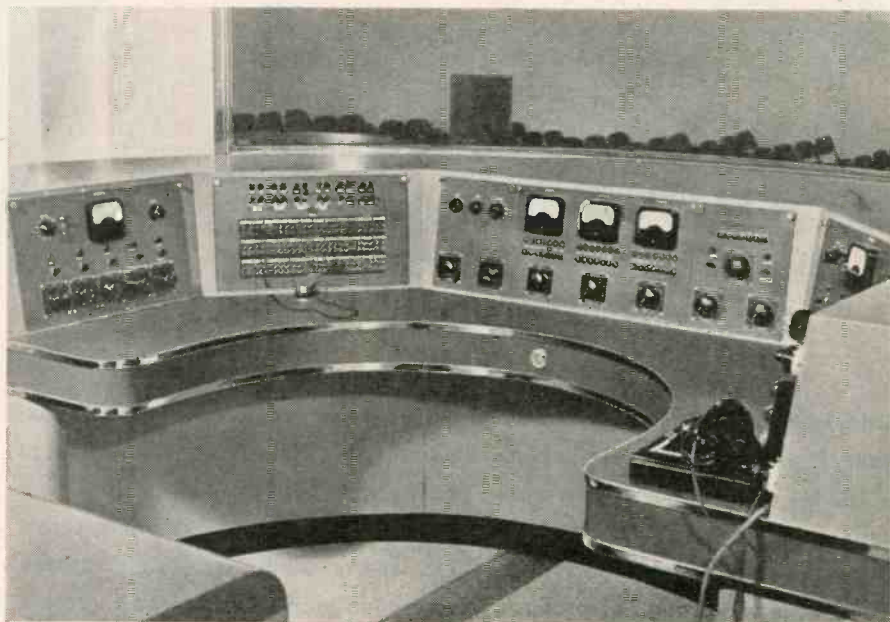

The specially built RCA control console in the master control room shared by WBRL and WJBO. Individual panels control the output from three studios. Network lines and remotes are controlled from a fourth panel. The push-button selector system in the center panel allows any program to be fed to each of the three output lines (one AM, one FM, one spare or network).

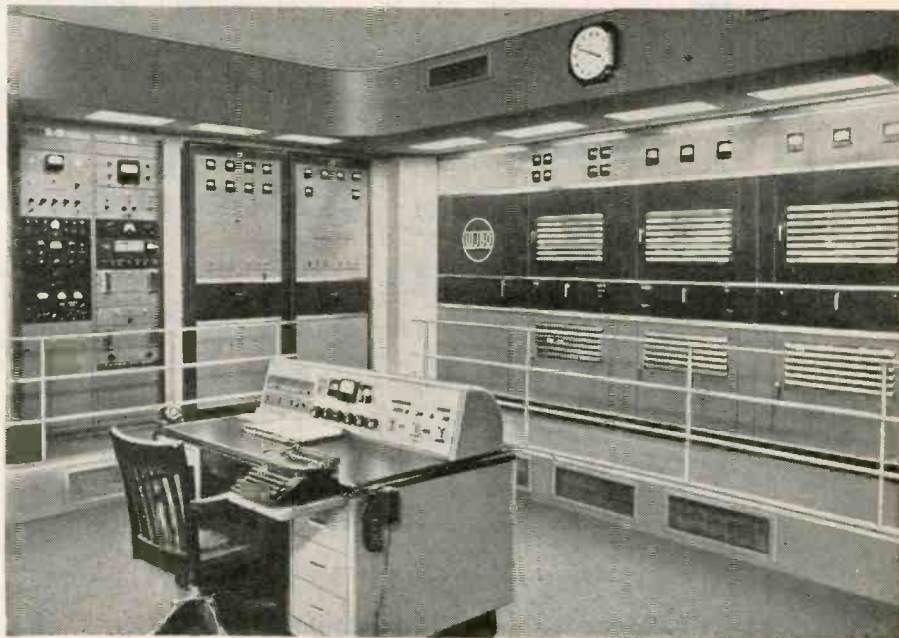

The transmitter room shared by WBRL and WJBO. The 1 KW FM Transmitter is the unit just left of center in this picture. At the far left are racks containing the FM audio input and monitoring units. At the right is the 5 KW AM transmitter. Not shown in this picture are the AM audio and monitoring racks and AM phasing units. All of the equipment in this picture is of RCA manufacture.

# Station WBRL uses RCA from Microphone to Antenna

WBRL, the FM station of the Baton Rouge Advocate and State Times, uses RCA equipment throughout. In the studios are RCA 44-BX Microphones; in the control room is a special RCA-built master control console. At the transmitter building are an RCA FM-1-A Transmitter and RCA frequency and modulation monitors. The antenna is an RCA-developed, six-bay, square-loop antenna.

WBRL is a sister station of WJBO, the AM station operated by the Baton Rouge Advocate and State Times. It is interesting to note that WJBO, like hundreds of other AM stations, is also completely RCA

equipped. Operators of AM stations know the meaning of "RCA all the way." And they know that in RCA FM equipment they will find the same dependability and the same advanced design features that they have come to expect in RCA AM equipment.

Operators of both AM and FM stations — and station applicants — can make reservations right now for early delivery of RCA postwar broadcast equipment. For information on our Broadcast Equipment Priority Plan, write to Broadcast Equipment Section, RADIO CORPORATION OF AMERICA, Camden, New Jersey.



Buy More War Bonds

## RADIO CORPORATION OF AMERICA

RCA VICTOR DIVISION • CAMDEN, N. J.

In Canada, RCA VICTOR COMPANY LIMITED, Montreal

*The transmitter plant of WBRL-WJBO. The AM antenna system consists of two 300-ft. and one 500-ft. (center) tower. The FM antenna system is mounted at the top of the latter. It is fed by a concentric transmission line from the transmitter building in the foreground. The entire layout was designed by WBRL and RCA engineers working together.*

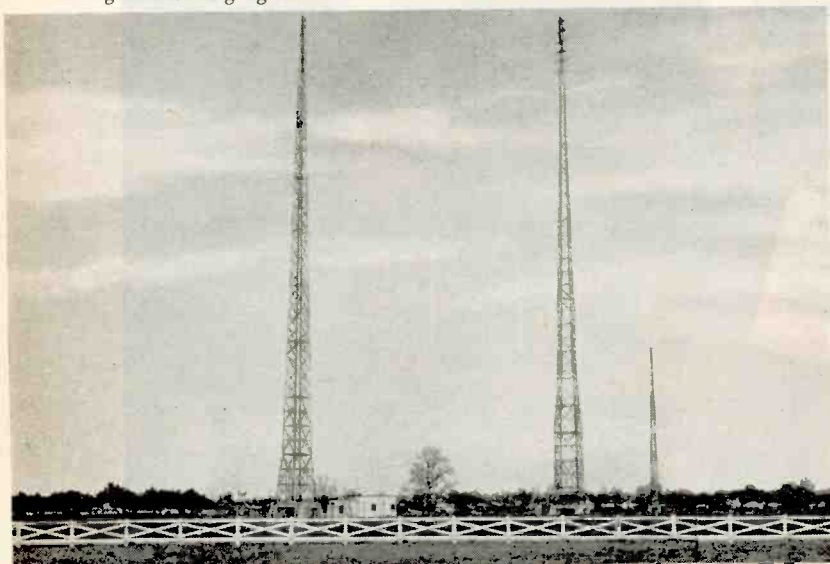

*A close-up of the six-bay FM antenna mounted on top of the 500-ft. AM tower. This antenna consists of square loops mounted around the tower. It was specially designed by RCA engineers to answer a particular mounting problem.*

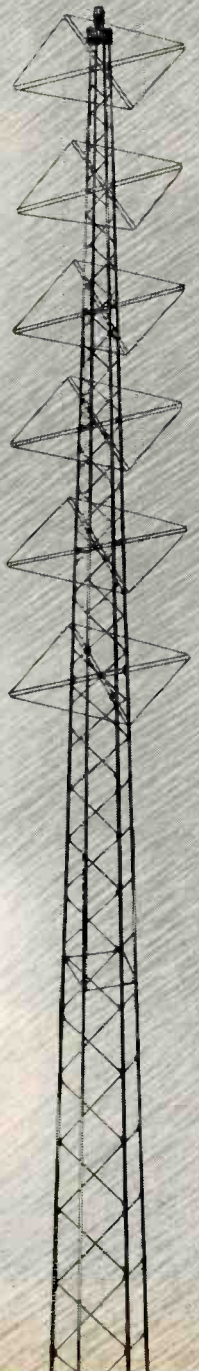

# For once, we were

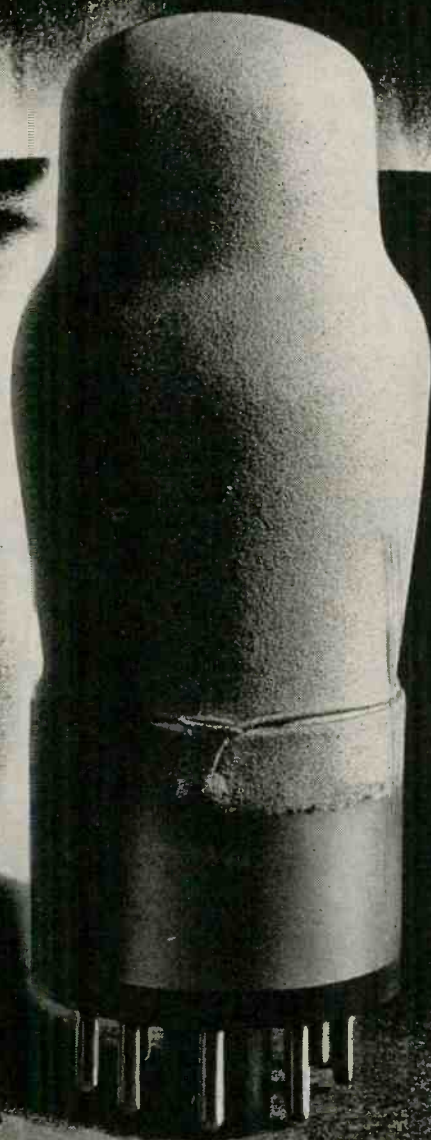

More than 1000 tubes like the one above, duplicates of an unknown German tube, were produced by Bell Labs and Western Electric in 17 days. They helped put an important enemy communications system back to work for our Army.

# copy-cats!

... *by special request*

Somewhere on the Western front, the retreating Germans left behind their strategic telephone communications system—all intact—*except that every vacuum tube had been removed from the repeaters.*

The Signal Corps went to work speedily to restore this valuable system for our own use. An engineer who had worked under the Germans supplied some general notes on the system and its operation. One tube believed to be of the missing type was found. Notes and tube were rushed to the U. S. by air.

*At Bell Labs*, tests and X-rays revealed the tube's inner construction and electrical characteristics and proved that no similar tube was available in this country. The German tube differed also in dimensions of the bulb and base and in the arrangement of the pins. Hurried consultations and calculations indicated that a suitable tube could be built from existing parts of American tubes—except for a grid and the base.

*At Western Electric*, the tube shop went to work—modified machines to wind the grid, and in three days produced eight tubes with hand-made bases, which were flown to Europe for trial in the system. Meanwhile, production went ahead at top speed and just 17 days after the lone German tube was received at Bell Labs, 1,015 duplicates of it had been completed. Result: the Signal Corps soon had the German telephone system in operation again.

*Bell Labs and Western* ordinarily wouldn't be happy about copying *anybody's* products. We developed the first repeater tubes—which later led to trans-Atlantic telephony and radio broadcasting. It has long been our tradition to create our own superior designs. Working together, Bell Labs and Western have solved many of the war's toughest electronic problems. After the war, count on this team for continued leadership in communications equipment.



## BELL TELEPHONE LABORATORIES

*Exploring and inventing, devising and perfecting for our Armed Forces at war, and for continued improvements and economies in communications.*



## Western Electric

*Manufacturing team-mate of Bell Labs, and the country's largest producer of communications and electronic equipment for war.*

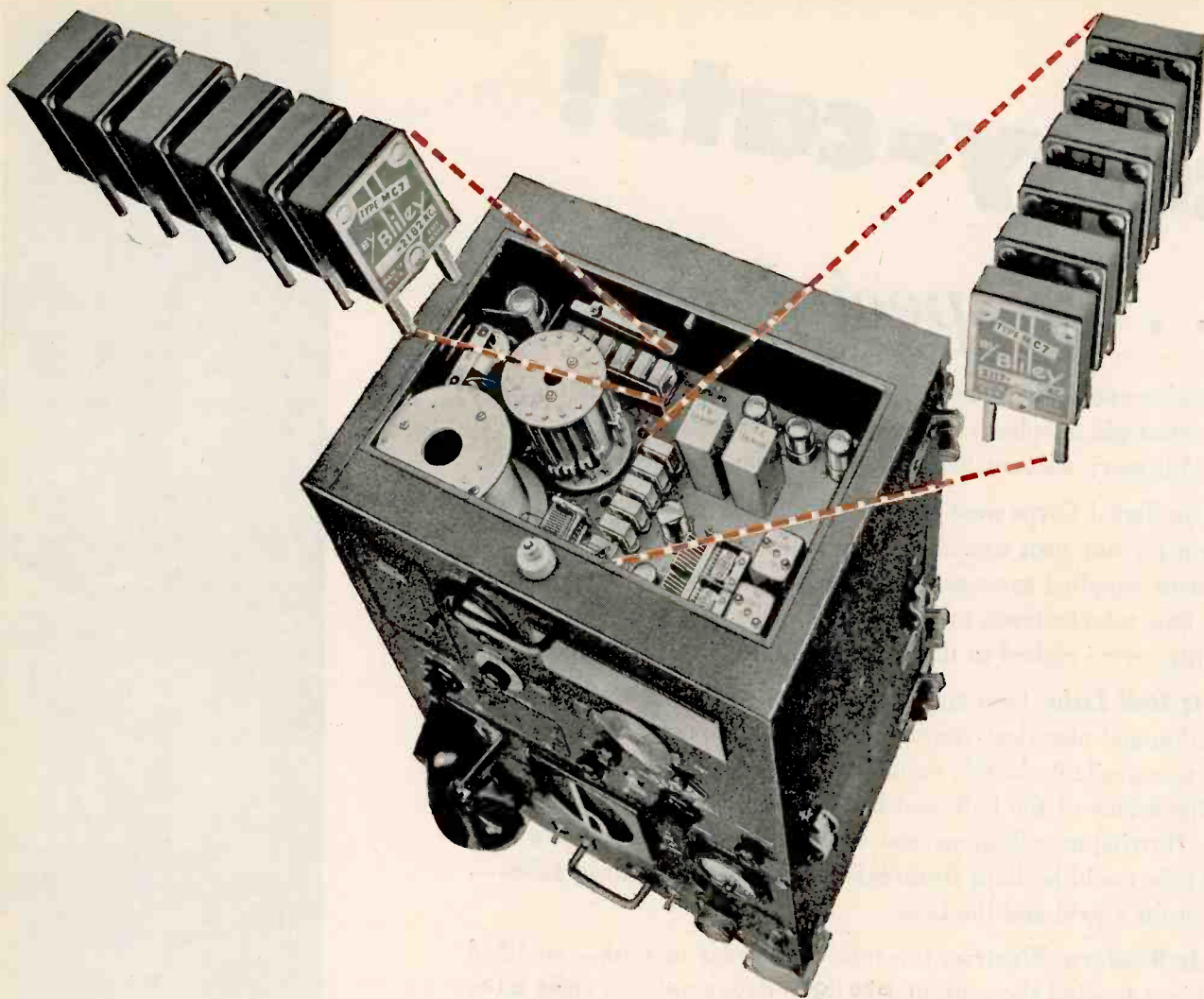

## The 6 operating frequencies are **BLILEY CRYSTAL**-controlled

For dependable communications on the high seas here is a battle-tested set incorporating every modern feature that experience has shown to be most desirable for ship-to-shore and ship-to-ship radiotelephone service.

The six Bliley crystal-controlled operating frequencies permit instant and positive channel selection

in both transmitter and receiver. The Bliley *acid etched*\* Crystals used in this Hallicrafters HT-14 set were designed to meet specific objectives in the operation of two-way radiotelephone communications. They, too, have been battle-tested.

It's a habit with most communications engineers to specify Bliley for all crystal requirements. This is par-

ticularly true today when new applications and complex designs require technical excellence in every component. There is no substitute for the 15 years of experience offered by Bliley craftsmen and engineers.

+ + +

*\*Acid etching quartz crystals to frequency is a patented Bliley process.*



# Bliley CRYSTALS

Do more than before...

buy extra War Bonds

**BLILEY ELECTRIC COMPANY**  
UNION STATION BUILDING • ERIE, PENN.





*“HYTRON Tubes Are Good—SO WHAT!”*

Sure, Hytron tubes are good — so what! All tubes made for Uncle Sam are good. They have to be, or he wouldn't accept them.

But Hytron goes further. Not satisfied just to meet Uncle Sam's JAN-1A specifications, it always sets factory testing specifications to tighter tolerances than the Services require. In this way, Hytron assures top quality

despite slight meter inaccuracies and the human element. When more uniform adherence to specifications can be attained, tests simulating actual equipment performance are added.

This same insistence on the best will continue after the war. Then, too, we shall say, "Hytron tubes are good — so what! They have to be good to be good enough for you."

OLDEST EXCLUSIVE MANUFACTURER OF RADIO RECEIVING TUBES

**HYTRON**  
RADIO AND ELECTRONICS CORP.

MAIN OFFICE: SALEM, MASSACHUSETTS  
PLANTS: SALEM, NEWBURYPORT, BEVERLY & LAWRENCE



**BUY ANOTHER WAR BOND**

# A MILLION MILES

## GENERAL CABLE CORPORATION'S ST. LOUIS PLANT CELEBRATES RECORD WIRE PRODUCTION ACHIEVEMENT



More than twenty months of inspired war effort on the part of the Men and Women Employees of the St. Louis Plant of General Cable Corporation were crowned today with gratifying success when the millionth mile of critical field communication wire, single conductor, rolled off the production line ready for shipment to our armed forces overseas.

This notable General Cable achievement, one of the most significant accomplishments in the production of a vital war material to be achieved in the St. Louis area and unequalled in performance in any communica-

tion wire plant in the world, marks an epochal milepost in the production of field wire which began in the local plant in October, 1943.

More than four thousand employees working on an average of fifty-seven hours per week in three shifts, seven days, are engaged in meeting the urgent requirements for field wire of the United States and its allies. Current production is running in excess of four thousand miles per day, putting it another way, approximately five times around the globe once a month.

In commenting on the production feat of the local organization, Mr. Dwight R. G. Palmer, President of General Cable Corporation stated, 'Though the performance of our St. Louis Plant was accomplished in the ordinary line of duty, Management nevertheless is particularly gratified that its personnel, comprising all races, creeds and colors, harmoniously evidenced their patriotic sincerity by establishing this outstanding record. We salute the Men and Women of our St. Louis Plant for this production achievement.'

a very great need to conserve and that is now

in preparation of income tax returns. Ordinary the C. P. A. must complete its proceedings within one year after bringing charges

company contracts sharply with the record of delays in the gram for production from

in court  
The  
their  
in has  
lawyer  
are a  
Estimate  
market  
and re  
among so  
according to  
tion come  
makes a  
guess, or  
Committee  
Food Sh  
that near  
black mar  
House Ap  
recommen  
tion of  
seven Fe  
ing first  
\$77,201  
the age  
mates.  
The  
ment of  
Agency  
sation,  
Labor  
tions  
thru  
at  
sis  
re  
de  
pr  
C  
col  
000  
of \$  
bring  
to \$  
pro  
M  
pr  
a  
ti  
pa  
ar  
th  
D  
D  
p

# OF FIELD WIRE...

Just one example of  
General Cable's Service to  
the Nation and its Allies

This output of *one million miles of single conductor communication wire* for the armed services represents the *all-out* effort at only one plant producing enough wire to encircle the globe five times each month.

All ten General Cable plants have been working three shifts, seven days per week, on this and other essential military items.

Come final Victory, General Cable will as energetically attempt to do its part in winning the peace.

## GENERAL CABLE CORPORATION



*Manufacturers of Bare and Insulated Wires and Cables  
for Every Electrical Purpose*

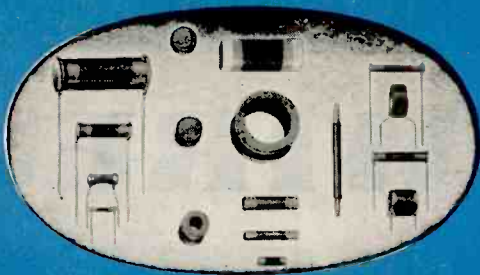

*Do you have a*

# TEMPERATURE MEASUREMENT OR CONTROL PROBLEM?

## CHECK THESE ADVANTAGES OF KEYSTONE NTC UNITS FOR YOUR APPLICATION

Keystone NTC units are electrical resistors especially developed to have an unusually high negative temperature coefficient of resistivity. The slopes are much greater than those observed with pure metals or their alloys. The result is an element with very high thermal sensitivity, useful on AC or DC, inherently suitable for remote indication, which has gained wide acceptance for temperature measurement and control purposes. NTC units are made in wide range of shapes, resistance values, temperature coefficients and wattage ratings, of which the characteristics at the left are typical. The circuits below suggest basic means for translating resistance changes into current or voltage variations. Modifications and extensions of these principles are many, especially in conjunction with electronic apparatus.

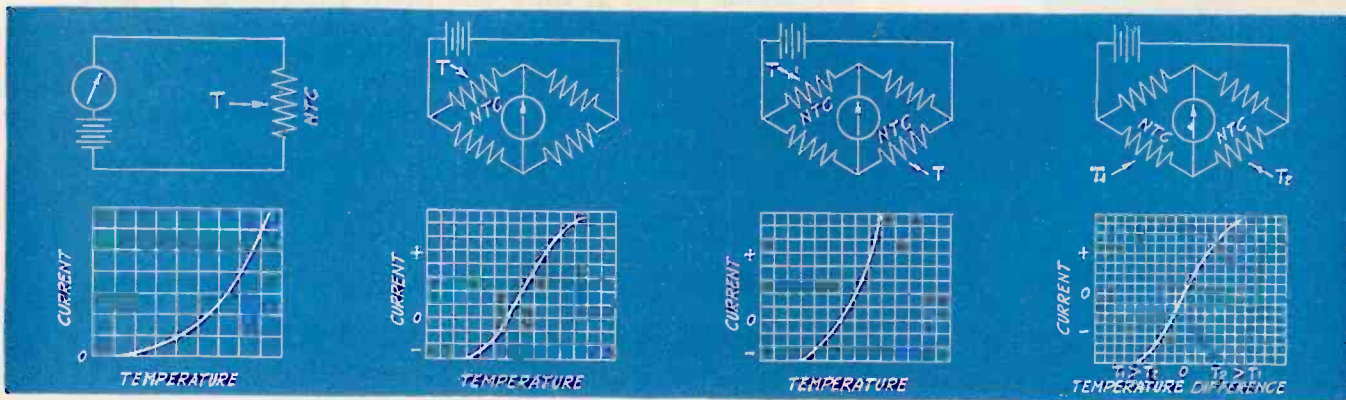
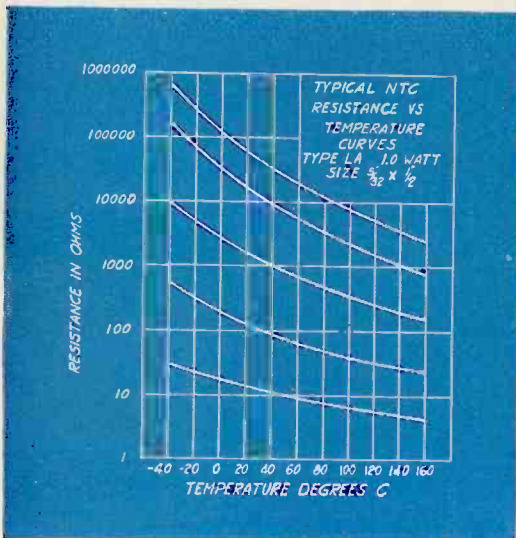

This simple series circuit of voltage source, instrument and NTC unit has been utilized to indicate engine coolant temperature, etc. It provides sufficient accuracy for many applications despite scale crowding at the bottom.

Basic bridge circuit straightens and steepens the characteristic. Zero-center meter may be used or balance point may be placed near the lowest temperature. Electronic balance indication provides enhanced sensitivity.

Adding a second NTC unit, and exposing both to the temperature to be indicated, gives a double unbalancing effect and increases sensitivity under certain conditions over part of the temperature range.

Two NTC units in adjacent arms is a method of indicating equality of two temperatures, or temperature difference or rise. Temperature of either source can be obtained by substitution of standard resistance for other NTC unit.

Keystone NTC resistors are also valuable for neutralizing the change in resistance with temperature of electrical indicating instruments and control devices, for introducing time delays and many other applications. Write and sell us about your problem—we'll be glad to analyze it for the applicability of NTC units.

**KEYSTONE CARBON COMPANY, INC.**  
SAINT MARYS . . . . PENNA.



# AIDING THE WAR TODAY . . . . .



# . . . . SERVING THE PEACE TOMORROW

Tomorrow, when the tools of strife are turned to the ways of peace, Jefferson Transformers will serve with the same fidelity. Improved manufacturing techniques established under the stress of war will be turned to producing still better transformers for your post war needs. Let Jefferson engineers examine your particular requirements now and make suggestions that will save you time later . . . JEFFERSON ELECTRIC COMPANY, Bellwood (Suburb of Chicago), Illinois. *In Canada:* Canadian Jefferson Electric Co. Ltd., 384 Pape Avenue, Toronto, Ont.

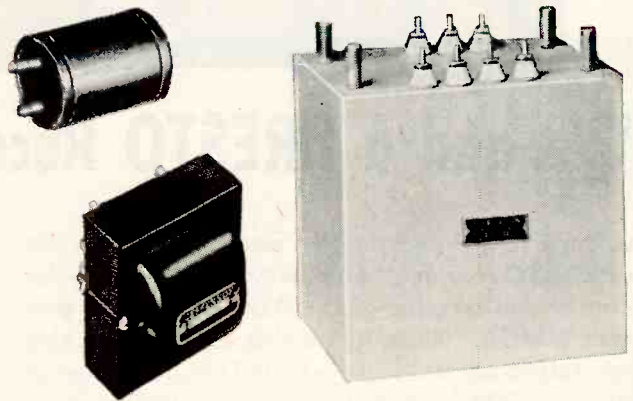

In all theatres of war, on the invasion beaches, wherever allied forces march against aggression, Jefferson Electric Transformers establish records of dependable performance. Today—on radio, radar, “walkie-talkies,” television communications systems, electronic and control applications,—Jefferson Transformers aid our war effort with a long-life reliability based on engineering skill and Jefferson’s basic principle of “quality—with quantity” production.



## T R A N S F O R M E R S

**"Hearing Myself As Others Hear Me**



**Is Mighty  
Important"**

**"...and a PRESTO Recorder Helps Me Do It!"**

"Yes, Sir, I frequently run off a recording of my voice on a PRESTO recorder," says Jerry Lawrence, popular announcer and director of the AIR THEATRE program at WMCA. "Then, by playing it back, I am able to keep tab on my technique—to find out if any change in delivery might improve it. Accurate reproduction is of course essential, and that's why I prefer a PRESTO recorder . . . it always produces cuts of good fidelity and clarity."

Many of America's major broadcasting companies

rely on PRESTO sound recording and transcription equipment to keep their stations operating at peak efficiency. In schools and colleges, and in the training of sales, industrial and military personnel, you'll find PRESTO equipment widely used to give dramatic significance to sound, and increase the effectiveness of the spoken word. PRESTO equipment is rugged, dependable and easily operated, because every unit is made in strict accordance with PRESTO'S high standards. Write for complete information.

**WORLD'S LARGEST MANUFACTURER**

**OF INSTANTANEOUS SOUND**

**RECORDING EQUIPMENT**

**AND DISCS**

**PRESTO**

**RECORDING CORPORATION**

242 West 55th Street, New York 19, N. Y.

Walter P. Downs Ltd., in Canada

# TINY OR TITANIC

No Job in Metal is Too Big  
or Too Small for KARP

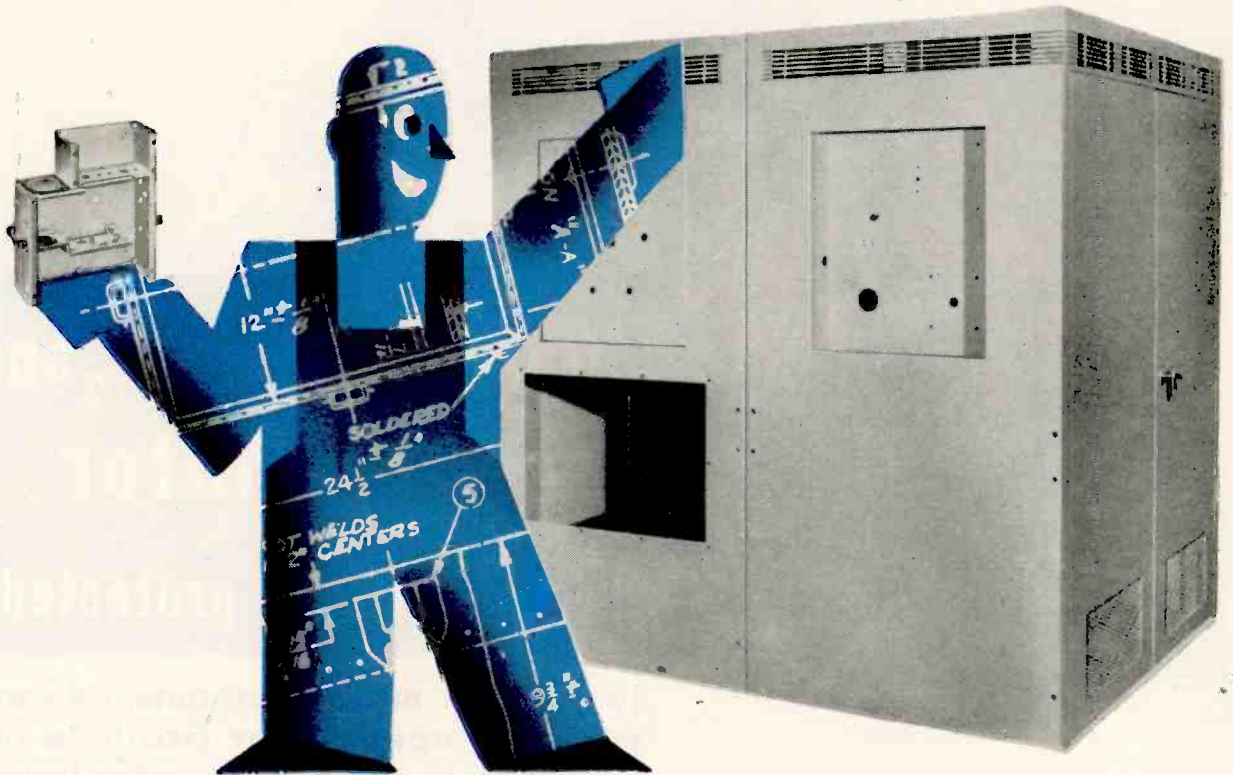

Bring your metal fabrication problems to KARP . . . and enjoy the superior individualized services of an organization that has been solving the toughest problems in precision metal craftsmanship for more than 20 years. Whether it's a tiny chassis, shield, or cabinet . . . or a giant rack or housing for broadcast or induction heating apparatus, KARP has the skill, the engineering "know how" and the plant facilities to serve you . . . and to assure you of reasonable delivery time. KARP ideas often effect important savings in both materials and machine tool time. KARP'S extensive stocks of dies often result in custom-made jobs at "ready-made" economies.

ANY METAL • ANY SIZE • ANY FINISH

# KARP

METAL PRODUCTS CO., INC.

*Custom Craftsmen in Metal*



124-30th Street, Brooklyn 32, N. Y.

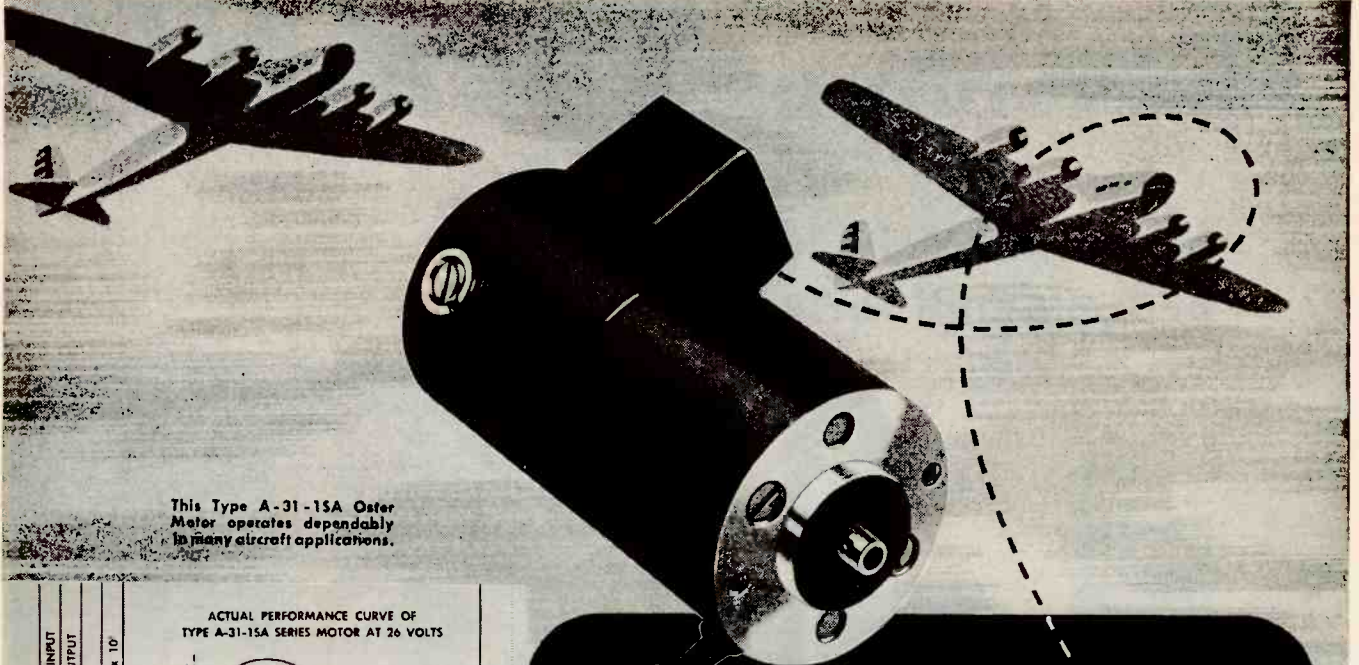

This Type A-31-15A Oster Motor operates dependably in many aircraft applications.

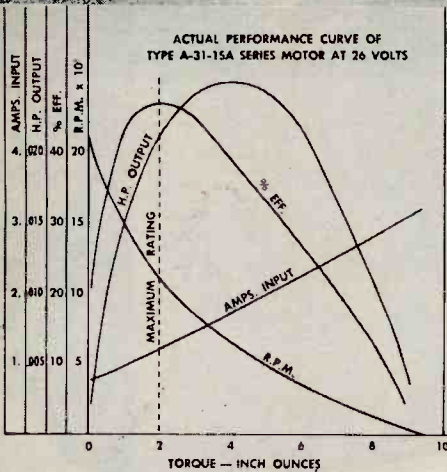

Now available... an  
*Oster* Motor  
REG. U. S. PAT. OFF.  
 thermostatically protected \*

to prevent motor burnouts, and adjusted to open motor circuit in approximately one minute under locked rotor conditions at rated voltage . . .

Here is another Oster motor with features that make it ideal for many applications in aircraft. The thermostatic control prolongs the life of the motor by preventing burnouts. Its weight (11 ounces) and body size (1½ x 3") are reduced to a minimum without impairing efficiency. The performance record is backed by 16 years of engineering experience in the fractional-horsepower field.

You can depend on it to deliver creditable results that add to your own reputation for selecting sources wisely. Let us help you fit this or other Oster motors to your requirements. Write for further details.

IN 1955 — YOU'LL WISH YOU HAD PURCHASED "EXTRA" BONDS IN 1945 — BUY YOURS TODAY!

MI-23

**Rating of type A-31-15A Motor**

- Horsepower — 1/50 intermittent.
- Speed — 10,000 rpm.
- Voltage — 26 D.C.
- Winding — series.
- Rotation — clockwise viewing rabbit end.
- Duty Cycle — 15 min. on — 30 min. off.

**Features of type A-31-15A Motor**

- Housing — die cast aluminum, totally enclosed. Finish — black anodized.
- Weight — 11 ounces.
- Bearings — High quality single shielded ball bearings, lubricated with grease suited for any specific application. Bearing housings fitted with steel inserts.
- Brushes — High grade metal graphite of ample size to assure unusually long brush life.
- Thermostatic Protector — Prevents motor burnouts, adjusted to open motor circuit in approximately one minute under locked rotor conditions at rated voltage.
- Temperature Rise — 55° C. maximum frame temperature rise at rated load.
- Mounting — Standard ¼" dia. Air Corps rabbet.
- Modifications — Special shaft extensions, mounting arrangements, leads, etc. Information regarding motors for specific applications furnished upon request.
- Suitable for various aircraft applications.
- All ratings and data are approximate.

**John Oster Manufacturing Co.**  
 DEPARTMENT E-23 • RACINE, WISCONSIN



*strength that is pre-destined*

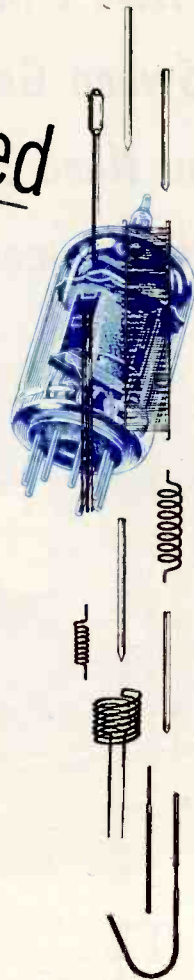

**Callite Tungsten Heaters in these Tung-Sol Miniatures will weather whip and any vibration . . . .**

The tiny Tung-Sol Tube type 6AK5, not much bigger than an acorn, has an enviable record in military equipment for its ability to stand abuse and remain efficient under adverse conditions.

Features, that contribute to the remarkable ruggedness of this miniature tube, are its unique plate construction, the method of anchoring the mount, and its Callite tungsten heater. These heaters are processed by Callite for Tung-Sol with the right

proportions of tungsten to give the required life and stability, plus the strength to withstand vibration and shock.

Through years of research in tungsten, molybdenum and special alloys, Callite has developed metallurgical components with the special qualities that facilitate tube-making and result in fine products. It will pay you to investigate our complete range of metallurgical specialities. Call on us for cooperation on designs and appli-

cations. Callite Tungsten Corporation, 544 Thirty-ninth Street, Union City, New Jersey. Branch Offices: Chicago, Cleveland.

**Callite**  
tube components



**HARD GLASS LEADS, WELDS, TUNGSTEN AND MOLYBDENUM WIRE, ROD AND SHEET, FORMED PARTS AND OTHER COMPONENTS FOR ELECTRON TUBES AND INCANDESCENT LAMPS.**

**Here's the RCA  
Sweep Generator  
You Need For Video  
Development Work**

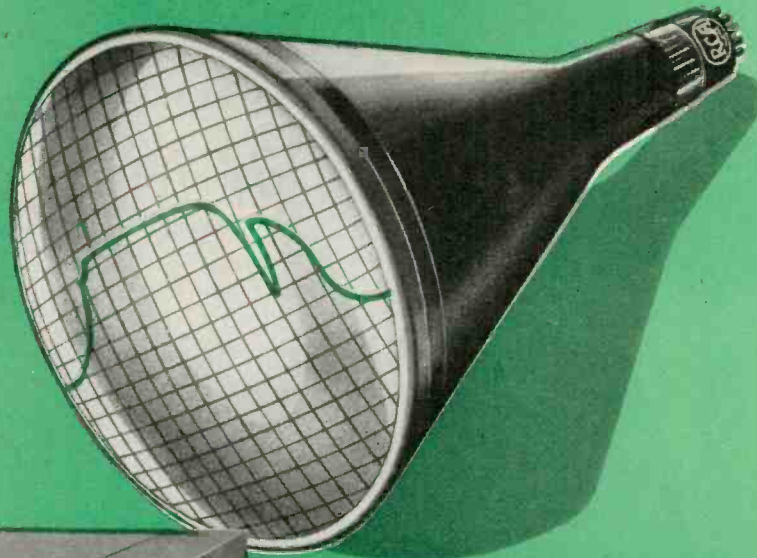

**RCA 711-A  
VIDEO  
SWEEP GENERATOR**

**T**HE RCA VIDEO Sweep Generator, Type 711-A, has been specially developed to meet the demand for a convenient, accurate means of testing and adjusting wide-band video amplifiers. When this generator is connected to the input of a video amplifier, and the output of the amplifier connected to a suitable oscilloscope, a trace is produced that accurately depicts the dynamic frequency characteristic of the amplifier.

The output of the 711-A changes smoothly from a low frequency, usually 100 k-c, to a high frequency, which may be easily adjusted to an upper range limit of 2 m-c to 9 m-c. The sweep to high frequency, and return, is completed in one cycle

of the power-line frequency.

An absorption type wavemeter coupled to the output circuit serves as marker. The marker frequency is controlled by a range switch and a large vernier dial calibrated in megacycles. A "blinking" circuit provides a base or zero-level line for qualitative checking. A built-in monitor diode, in conjunction with an oscilloscope, permits checking wave shape and linearity of output.

Write for more information about the 711-A Video Sweep Generator, and the RCA 709-B wide-band Sweep Generator, which operates in the 5 to 65 m-c range. Use the coupon below.

BUY WAR BONDS

USE THIS COUPON TO GET SWEEP GENERATOR BULLETINS

TEST AND MEASURING EQUIPMENT SECTION,  
Radio Corporation of America, Camden, N. J.

Send me more information about RCA Sweep Generators.

Name.....

Street Address.....

City and State.....

138-C



**RADIO CORPORATION OF AMERICA**

RCA VICTOR DIVISION • CAMDEN, N. J.

In Canada, RCA VICTOR COMPANY LIMITED, Montreal

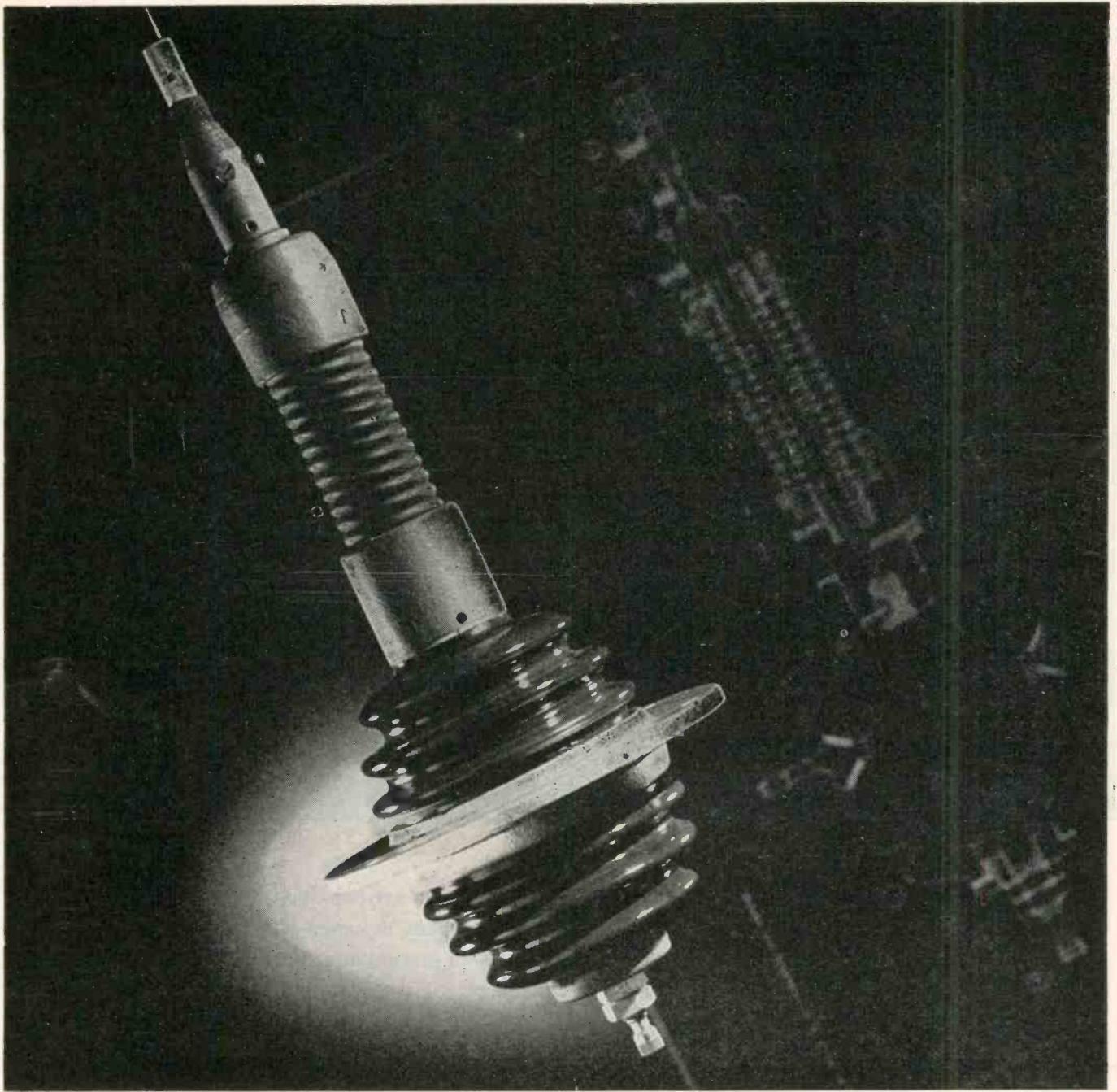

## LAPP-DESIGNED, LAPP-BUILT—TO DO A SPECIFIC JOB

This is an antenna base insulator for use on a communications center transmitter. It is one of several Lapp designs for transmitter and receiver mast bases for military vehicular radio—on jeeps, halftracks, tanks and other rolling equipment.

Whether or not this special-purpose gadget has application to anything you build or propose to build, there's a moral in it for you. In this case, as in hundreds of others, an original and impractical design was modified by Lapp engineers—to provide a part that meets all electrical and mechanical requirements, and that Lapp can build economically and efficiently.

Lapp engineering talent and Lapp production methods are such that we can say, "If it's an assembly that can be made of porcelain or steatite and metal parts, tell us what

the requirements are and how you think it might be made; Lapp will tell you how it can best be made—and will make it." Our right to that claim has been proved over and over in military electronic production; it's going to be a competitive advantage to smart post-war electronic producers. *Lapp Insulator Co., Inc., LeRoy, N. Y.*





# WILCO ANNOUNCES

**Larger Plant**

**New Equipment**

**Increased Facilities**

**for producing**

**TUBING**

The demand for Wilco tubing, wire and other products used in various electronic applications for the Army and Navy has caused the H. A. Wilson Company to increase its manufacturing facilities and develop new products and techniques. Both present and future customers will find these new Wilco developments of great advantage.

The H. A. Wilson Company manufactures and is interested in receiving inquiries regarding the following products—

## **WILCO RADIO TUBING**

Silver Tubing (Fine, Coin, Sterling)

Gold Tubing (any karat)

Gold on silver (on one or both sides)

Gold on bronze (on one or both sides)

Silver on copper (on one or both sides)

Tubing made to order from special materials or any combination of materials.

## **WILCO RADIO WIRE**

Silver (Fine, Coin, Sterling)

Silver-jacketed Invar

Silver-jacketed Brass and Bronze

Silver-jacketed Copper

Gold Wire

Gold on silver

Gold-jacketed Bronze and Brass

Any other type of jacketed wire desired

---

*Let us analyze your problems. Write*

## **THE H. A. WILSON COMPANY**

105 Chestnut Street, Newark 5, N. J.

Branches: Detroit • Chicago

# GIRDER CONSTRUCTION...

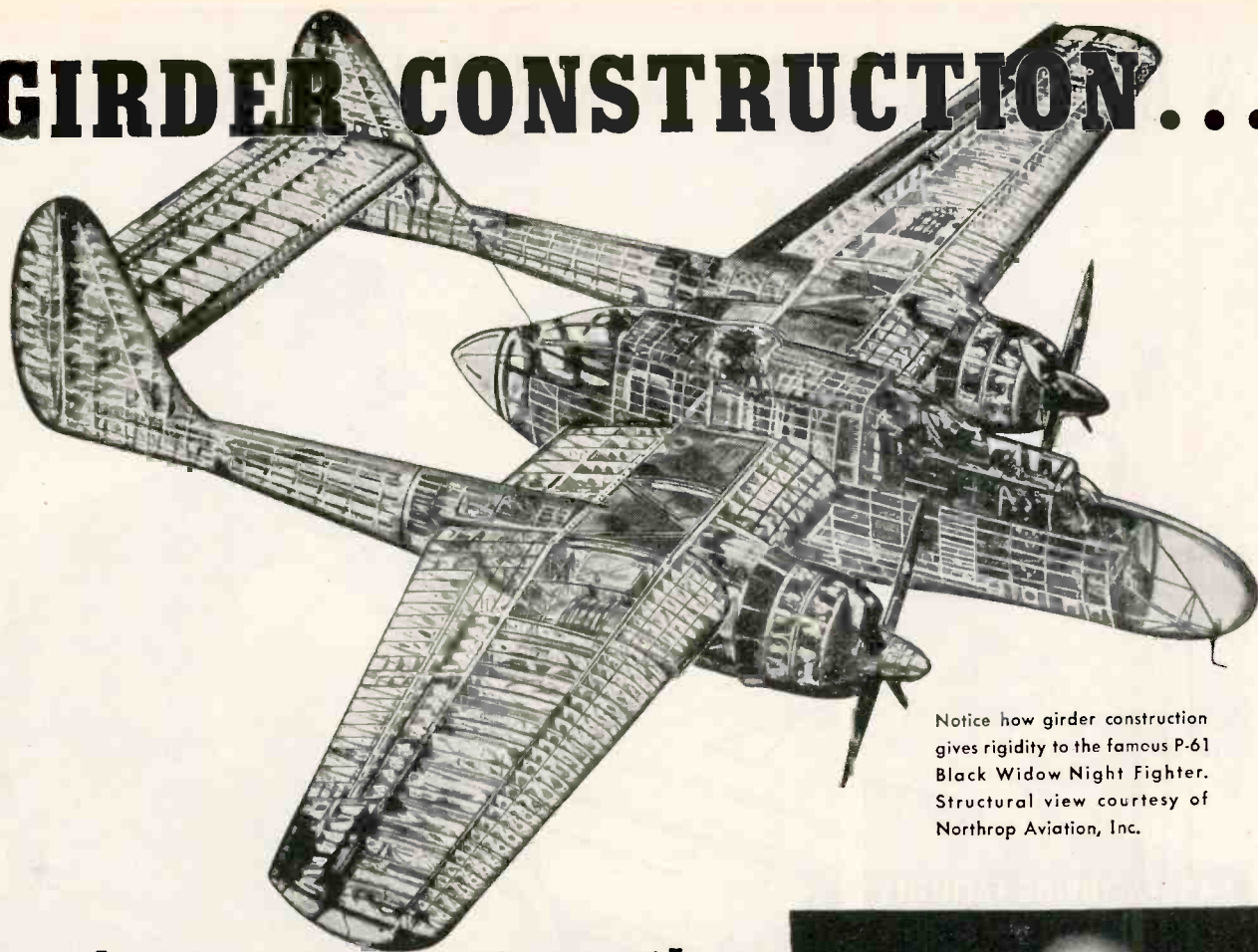

Notice how girder construction gives rigidity to the famous P-61 Black Widow Night Fighter. Structural view courtesy of Northrop Aviation, Inc.

## gives greater strength to *Gammatron Tubes*

The same type of construction which gives strength and rigidity to a modern airplane, skyscraper, or bridge has been successfully incorporated into the design of the HK-854 and HK-1054 triodes. Compare the girder construction of the P-61 with the plate and grid supports of the HK-1054—the structural principles are identical! Note particularly how the heavy tripod plate support is welded to large diameter tubing, which in turn is firmly secured to the copper plate cup.

Because of their girder construction, HK-854 and HK-1054 Gammatrons stand up exceptionally well even when subjected to the vibration and stresses which usually accompany their use in such industrial applications as dielectric heating.

This superior internal strength is important since it prevents internal shorts, and variations in the characteristics of the tubes due to movement of the elements.

### NEW LOW PRICES NOW IN EFFECT

TUBE TYPE	NEW LIST PRICE
HK 854-H (High amplification factor)	Now only \$60.00
HK 854-L (Low amplification factor)	Now only 60.00
HK 1054-L (Low amplification factor)	Now only 135.00

KEEP BUYING  WAR BONDS

**HEINTZ AND KAUFMAN LTD.**  
SOUTH SAN FRANCISCO · CALIFORNIA

EXPORT AGENTS: M. SIMONS & SON,  
25 WARREN STREET, NEW YORK CITY, U. S. A.

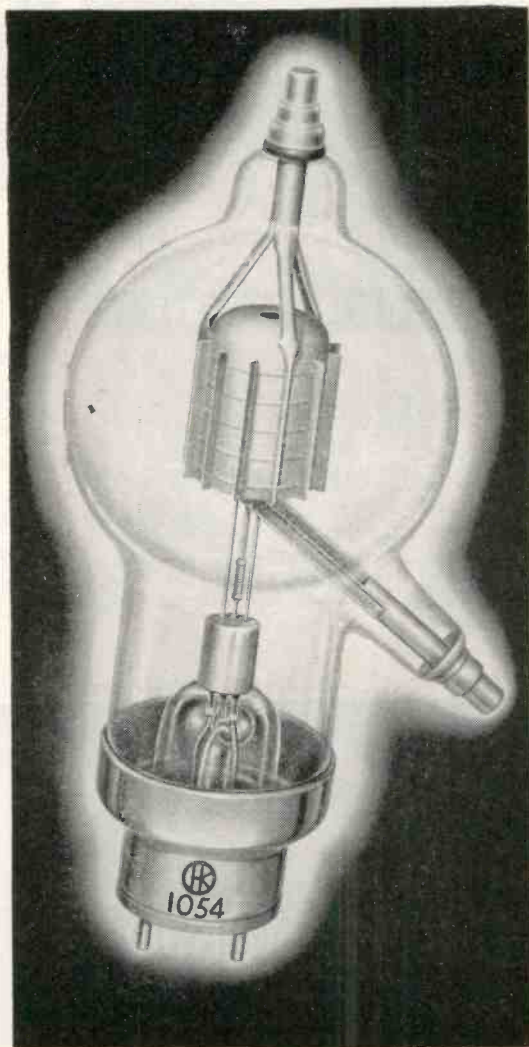

# SELECTOR MECHANISMS

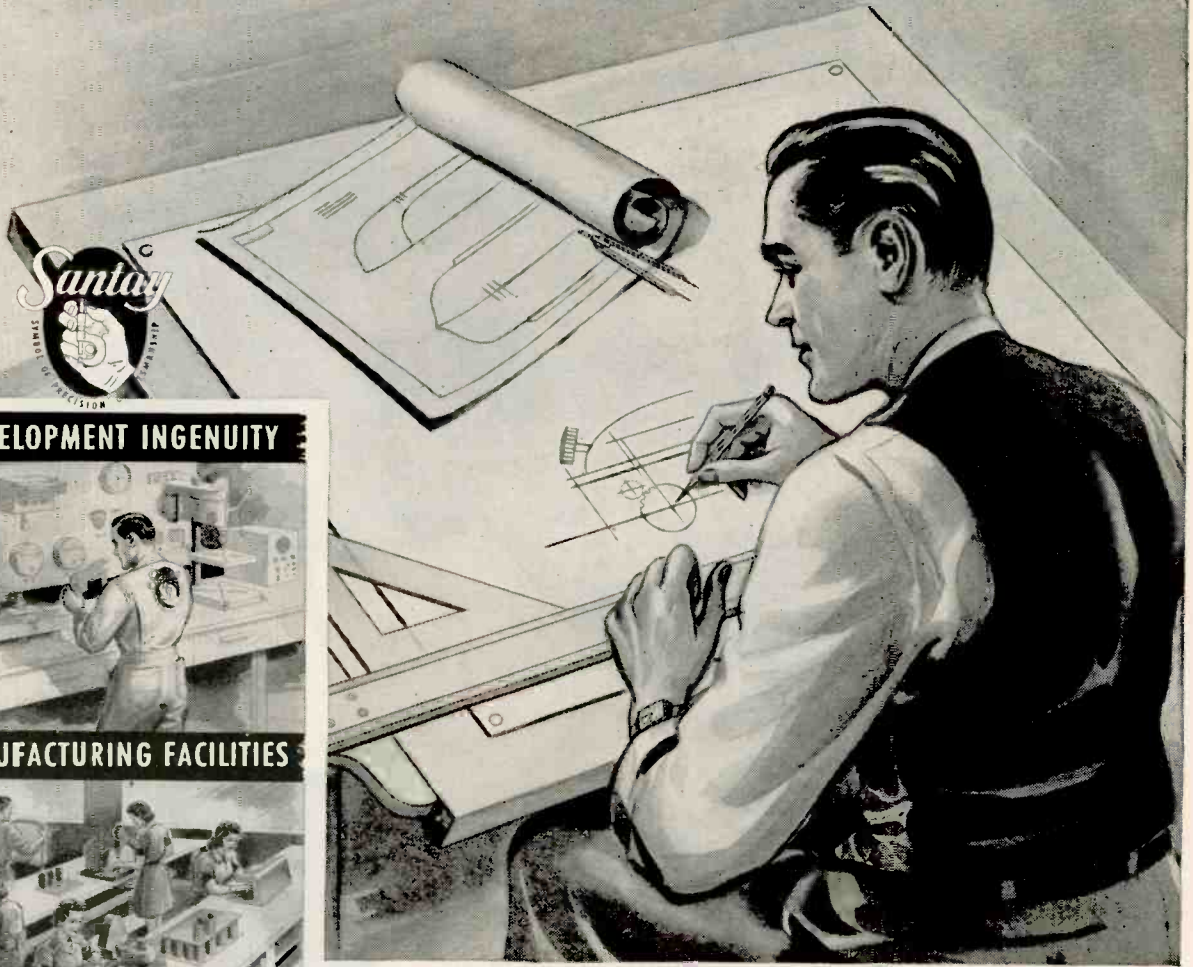

## DEVELOPMENT INGENUITY



## MANUFACTURING FACILITIES



## DESIRE TO SERVE



## DESIGN ABILITY

Santay possesses design ability in its most tangible form. (1) the experience of its Engineering Staff in *conceiving*; (2) followed by *product design*, (3) nursing the early *production* through its *growing pains* and, (4) *field testing* a product in actual use.

Santay recognizes there is no substitute for good design; therefore, they continue to strengthen their Engineering Staff. Still finer designs may be expected from this outstanding producer of Selector Mechanisms.



INJECTION MOLDING AND METAL STAMPING • ELECTRO-MECHANICAL ASSEMBLIES



**SANTAY CORPORATION, 353 NORTH CRAWFORD AVE., CHICAGO 24, ILLINOIS**

REPRESENTATIVES: POTTER & DUGAN, INC., 29 WILKESON STREET, BUFFALO 2, NEW YORK • PAUL SEILER, 7779 CORTLAND AVENUE, DETROIT 4, MICHIGAN • QUEISSER BROS., 108 E. NINTH STREET, INDIANAPOLIS 2, INDIANA

# RADIO RECEPTOR'S NEW "MASTER" SERIES THERMATRON ATTRACTING WIDE ATTENTION

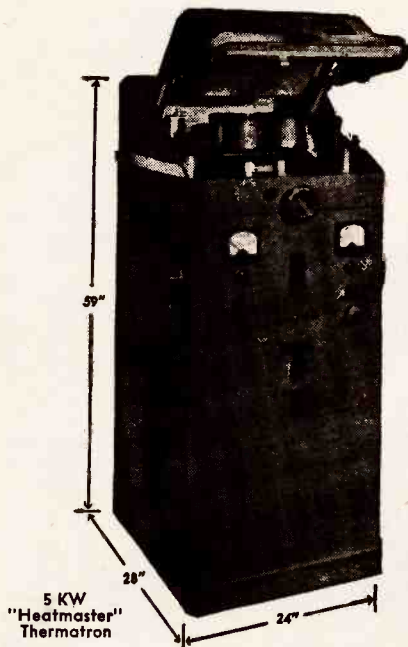

The new "Master" Series of THERMATRON electronic dielectric heat generators, headed by the popular 5 Kilowatt output "Heatmaster," is now enlarged by the addition of two new models. They are the "Heatmaster, Jr.," with an output of 2½ Kilowatts, and the "Weldmaster" and "Weldmaster, Jr.," especially designed for sealing and bonding thermoplastic sheets, with outputs of 1 Kilowatt and 500 Watts respectively. According to *Radio Receptor* engineers, each of these machines fills a definite place in the new industry which is growing up around electronic heating.

The "Heatmaster" illustrated gives a new high value per dollar in electronic heating, and has the additional advantage of occupying little floor space. As shown, it incorporates a built-in, highly shielded "oven," or electrode cage, automatically operated, and designed especially for the plastic and rubber industry. It is also sup-

plied without the "oven" so that it may be used with external electrodes in connection with conveyor belts or other applications. Floor space is only 24" x 48".

The "Heatmaster, Jr." embodies the same excellence in design, manufacture and the use of highest class standard components including the new type radial fin tubes as the "Heatmaster," but has an output of 2½ Kilowatts or a BTU output of 8550 per hour as against the 17,000 BTU's of the larger model. The same safety features and simplicity of control as characterize the larger model are found in the "Heatmaster, Jr." Both models are available at 27.4 mc frequency, and at 15 and 5 mc as may be required. Other frequencies can be supplied. The larger model operates on 200 volt 60 cycle three-phase current, while the smaller unit runs on 200 volt 60 cycle single-phase.

A folder describing the complete THERMATRON line will be forwarded on request.

## "Desalter" Life Saver Produced on THERMATRON Machines

The Permutit Company's "desalter," which makes sea water potable in 20 minutes and which has been supplied by the hundreds of thousands to Army and Navy fliers who may be possibly forced down at sea, is known to many. It is one of the outstanding developments of the war. But what is not generally known is that the Gemloid Corporation of Elmhurst, Long Island, which makes a large proportion of these "desalters," uses THERMATRON in their assembly. THERMATRONS of the "Weldmaster" series are designed especially to weld, seal or bond thermoplastics such as Vinylite, of which these bags are made. Both the "Weldmaster" of 1 KW output and the "Weldmaster, Jr.," which has an output of 500 watts, are designed for welding or bonding thermoplastics. The Permutit "desalter" is a tough, collapsible, non-corrodible plastic bag

with a simple strap closure and built-in filter that can be used over and over again. This product is the forerunner of many other plastic products to be manufactured economically on THERMATRON electronic heat welders by Gemloid and other plastics products makers.

Already, manufacturers of such products as raincoats, shower curtains, baby pants, tobacco pouches, cosmetic bags and other articles of widespread use, are displaying great interest in this new production method which offers so many outstanding advantages.

*Radio Receptor Company's* laboratories offer manufacturers a complete service in the adaptation of electronic dielectric heating equipment in their manufacturing processes. While the plastic industry has been among the first to grasp the possibilities of this new tool, many other industries are



Permutit Desalting Bag

searching out its potentialities and are making plans to use THERMATRONS as soon as they become more generally available.



**RADIO RECEPTOR COMPANY, Inc.**  
251 WEST 19th STREET

NEW YORK 11, N. Y.

Engineers and Manufacturers of Airway and Airport Radio Equipment  
SINCE 1922 IN RADIO AND ELECTRONICS





# COILS

*Before the war  
We made millions of coils each year  
For many years.*

*Our organization was mass-production minded.  
That organization is intact.  
We are still mass-production minded.  
Be safe.*

*Order your mass-production coils and trimmers  
from people who "know how".*



**AUTOMATIC**  
**MANUFACTURING**  
CORPORATION

MASS PRODUCTION COILS & MICA TRIMMER CONDENSERS

900 PASSAIC AVE.

EAST NEWARK, N. J.



# HOW hallicrafters EQUIPMENT COVERS THE SPECTRUM

MODEL SX-28A — from 550 kc to 42 Mc

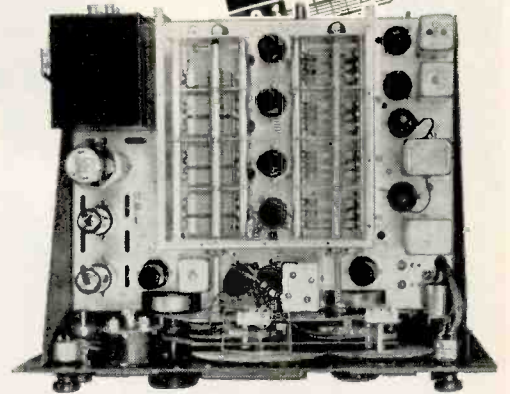

**H**ALLICRAFTERS Super Skyriders, Model SX-28A, covers the busiest part of the radio spectrum — standard broadcast band, international short wave broadcast bands, long distance radio telegraph frequencies, and all the other vital services operating between 550 kilocycles and 42 megacycles. Designed primarily as a top flight communications receiver the SX-28A incorporates every feature which long experience has shown to be desirable in equipment of this type.

The traditional sensitivity and selectivity of the pre-war SX-28, ranking favorite with both amateur and professional operators, have been further improved in this new Super Skyriders by the use of "micro-set" permeability-tuned inductances in the RF section. The inductances, trimmer capacitors and associated components for each RF stage are mounted on small individual sub-chassis, easily removable for servicing.

Full temperature compensation and positive gear drive on both main and band-spread tuning dials make possible the accurate and permanent logging of stations. Circuit features include two RF stages, two IF stages, BFO, three stage Lamb-type noise limiter, etc. Six degrees of selectivity from BROAD IF (approximately 12 KC wide) for maximum fidelity to SHARP CRYSTAL for CW telegraphy are instantly available. Speaker terminals to match 500 or 5000 ohms are provided and the undistorted power output is 8 watts.



BUY A WAR BOND TODAY

## hallicrafters RADIO

COPYRIGHT 1945 THE HALLICRAFTERS CO.

THE HALLICRAFTERS CO., CHICAGO 16, U.S.A., WORLD'S LARGEST EXCLUSIVE MANUFACTURERS OF SHORT WAVE RADIO COMMUNICATIONS EQUIPMENT



**Just another of the  
quality controls that**

**put the final OK on AEROVOX**

## **CAPACITOR CRAFTSMANSHIP**

● "Leakers" are few and far between in Aerovox oil capacitors. And here's why:

Each and every oil-filled capacitor is examined under ultra-violet or so-called "black" light. The slightest trace of impregnating oil seeping through seams or cracks in containers, shows up as a bright fluorescent spot as the operator peers through the cabinet window. A "leaker" just cannot get by.

Such typical Aerovox quality inspection

means much to the oil capacitor user. The life of such capacitors is dependent upon perfect hermetic sealing. This prevents the entry of moisture. Also, even a slight oil leak might damage or interfere with the operation of associated equipment.

Outstanding quality control — from incoming raw materials through each step in production and on to final inspection — is the final endorsement of Aerovox Capacitor Craftsmanship.

● **Submit your capacitance problems and requirements.**



# **AEROVOX**



# *Capacitors*

**INDIVIDUALLY TESTED**

AEROVOX CORPORATION, NEW BEDFORD, MASS., U. S. A.

SALES OFFICES IN ALL PRINCIPAL CITIES

Export: 13 E. 40 ST., NEW YORK 16, N. Y. • Cable: 'ARLAB' • In Canada: AEROVOX CANADA LTD., HAMILTON, ONT.

CROSS-SECTION (4½ times actual size) of coaxial cable, Type R.G. 5U, produced by American Phenolic Co., Chicago, Ill., is used in television transmission, from camera to control room to transmitter, by Allen B. Du Mont Laboratories, Inc., Passaic, N. J. (A) conductor; (B) Polythene insulation; (C) copper sheathing; (D) outside jacket.



**FOR LOW POWER LOSS  
AT HIGH FREQUENCIES**

# TELEVISION CABLES ARE INSULATED WITH Du Pont POLYTHENE

SOME OF THE CIRCUITS used in television transmission carry electrical current which changes its direction at the rate of 100 million cycles per second. This extremely high frequency is one of the chief reasons why polythene, a versatile Du Pont plastic, is chosen for insulating coaxial cables used in television transmission.

*Polythene is non-polar.* Unlike most other insulating materials, its molecules are not influenced by the cycles of oscillation of a current—no matter how rapid.

For this application, polythene's non-polarity is perhaps the most striking advantage. It is far from being the only advantage. Consider, for instance, these others:

1. Polythene's dielectric constant (2.2—2.3) and its power factor (less than 0.0005) remain almost constant over a wide range of temperatures, from—50°F to 220°F.
2. Polythene's specific gravity is 0.92.
3. Polythene has outstanding chemical inertness.
4. Its moisture absorption is less than 0.005 per cent.
- 5 Polythene is flexible over a wide range of temperatures.

This unique combination of properties is responsible for polythene's displacement of other materials in insulating high-frequency wires used by the U.S. Army Signal Corps. This same combination of properties will see polythene advancing into many



Du Mont Portable Television Equipment in Studio Use.

other fields as soon as it is less urgently needed on the war fronts.

Du Pont is now producing polythene under WPB allocation. Quantities up to 25 pounds for experimental purposes can be obtained according to WPB Order M-300, Schedule 60. Write for properties chart and other data to E. I. du Pont de Nemours & Co. (Inc.), Plastic Department, Arlington, N. J.



BETTER THINGS FOR BETTER LIVING  
... THROUGH CHEMISTRY

*For Plastics—consult DU PONT*

**ALWAYS A GOOD BUY—WAR BONDS!**

# Centralab

## Medium Duty Power Switches



- 7½ amp, 115 V, 60 cycle A. C.
- Voltage breakdown 2500 V to ground D. C.
- Solid silver contacts
- 25,000 cycles of operation without contact failure
- Fixed stops to limit rotation
- 20° indexing

Centralab medium duty power switches are now available for transmitters (has been used up to 20 megacycles) power supply converters and for certain industrial and electronic uses.

It is indicated in applications where the average Selector Switch is not of sufficient accuracy or power rating. Its accuracy of contact is gained by a square shaft, sleeve fit rotor, and individually aligned and adjusted contacts. It is assembled in multiple gangs with shorting or non-shorting contacts. Torque can be adjusted to suit individual requirements. Furnished in 1 pole . . . 2 to 17 positions (with 18th position continuous rotation with 18th position as "off"); and 2 or 3 pole . . . 2 to 6 position including "off".

# Centralab

Division of GLOBE-UNION INC., Milwaukee

PRODUCERS OF Variable Resistors • Selector Switches • Ceramic Capacitors • Fixed and Variable • Steatite Insulators and Silver Mica Capacitors

# Again KAAR is FIRST!

fm

INSTANT

HEATING



## KAAR makes 50 and 100-watt mobile FM practical with instant-heating tubes

Kaar engineers—who pioneered instant-heating AM radiotelephones—have done it again! In presenting the new KAAR FM-50X and FM-100X, they now give you the advantages of FM *plus* instant-heating tubes... greater power and range

with lower battery drain! Standby current is zero. Yet the instant you press the button microphone, you are on the air with a full 50 or 100 watts output, improved voice quality, and minimum distortion—sending out a strong, clear message that insures excellent reception.

KAAR FM TRANSMITTER  
MODEL FM-50X  
50 WATTS OUTPUT

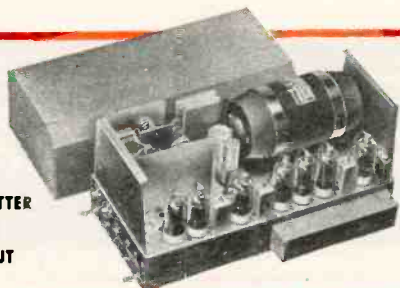

# KAAR



ENGINEERING CO.

PALO ALTO • CALIFORNIA

Export Agents: FRAZAR & HANSEN • San Francisco, California

**Another  
"First"!**

25,000 volts accelerating potential on a cathode-ray tube...

# DUMONT MULTI-BAND

TYPE 5RP CATHODE-RAY TUBE



Cylindrical flat-face tube. Approximately the size of conventional 5-inch tubes. Deflection-plate leads brought out through neck instead of base. Shunt input capacities and cross-coupling effects reduced to minimum. Second anode and intensifier leads brought out through envelope to facilitate high-voltage operation.

► We repeat: 25,000 volts accelerating potential on a cathode-ray tube! That's front-page electronic news. Likewise cathode-ray history in the making.

The DuMont Multi-Band Tube (Type 5RP) permits recording at writing rates in excess of 2500 km/sec (using a 35 mm camera with f:1.9 lens) corresponding to sine wave transients at 10,000 megacycles!

This is a hot-cathode, permanently-sealed, high-vacuum tube. Subdivision of the intensifier element provides a controlled gradient allowing a total accelerating potential of 25,000 volts to be employed, with only slightly reduced deflection sensitivity. Greatly increased brightness with small spot size results in a writing rate far exceeding that heretofore obtainable.

Yes, DuMont pioneering continues.

► Literature on request.

© ALLEN B. DUMONT LABORATORIES, INC.

# DUMONT

*Precision Electronics & Television*

ALLEN B. DUMONT LABORATORIES, INC., PASSAIC, NEW JERSEY



**INTRICATE** *Small Gear*  
*Problems solved*



Making fine, Fractional Horsepower Gears *to the most exacting specifications* is a highly developed specialty of ours. So well known is the unusual skill and accuracy of GS craftsmen, in working to extreme tolerances that long since we've become the "world's largest exclusive manufacturers of Fractional Horsepower Gears"! Should your post-war plans include products in which better small gears are involved, by all means submit your problem to our staff of long experienced engineers.

FRACTIONAL HORSEPOWER 1/2 TO 96 D.P.

# GEAR Specialties

Spurs • Spirals • Helicals • Bevels • Internals • Worm Gearing • Racks • Thread Grinding  
2635 WEST MEDILL AVENUE • CHICAGO 47, ILLINOIS

WORLD'S LARGEST EXCLUSIVE MANUFACTURERS OF FRACTIONAL HORSEPOWER GEARS



# AUTO-LITE

## *Electrical* Wire AND Cable

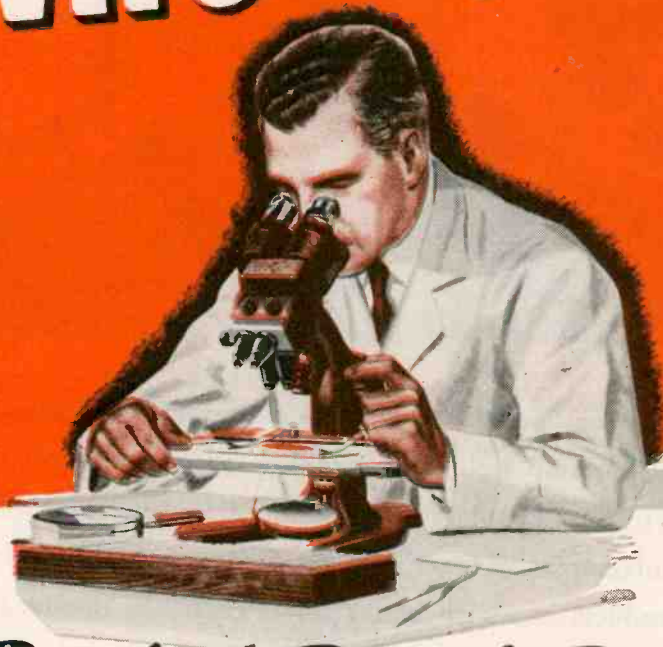

### *The Proof of Sound Engineering*

Many years of experience in meeting the need of the users of wire in many industries, laboratory research and a continuing effort to develop the finest manufacturing methods and devices —this has made Auto-Lite the quality line of

wire and cable. There is a full range of sizes, shapes and materials for every wiring need.

Should new designs present unusual problems for wire in your product, take advantage of this Auto-Lite engineering experience. Just write to

**THE ELECTRIC AUTO-LITE COMPANY**

PORT HURON, MICH.

*Wire and Cable Division*

SARNIA, ONT.

TUNE IN "EVERYTHING FOR THE BOYS" STARRING DICK HAYMES—TUESDAY NIGHTS—NBC NETWORK



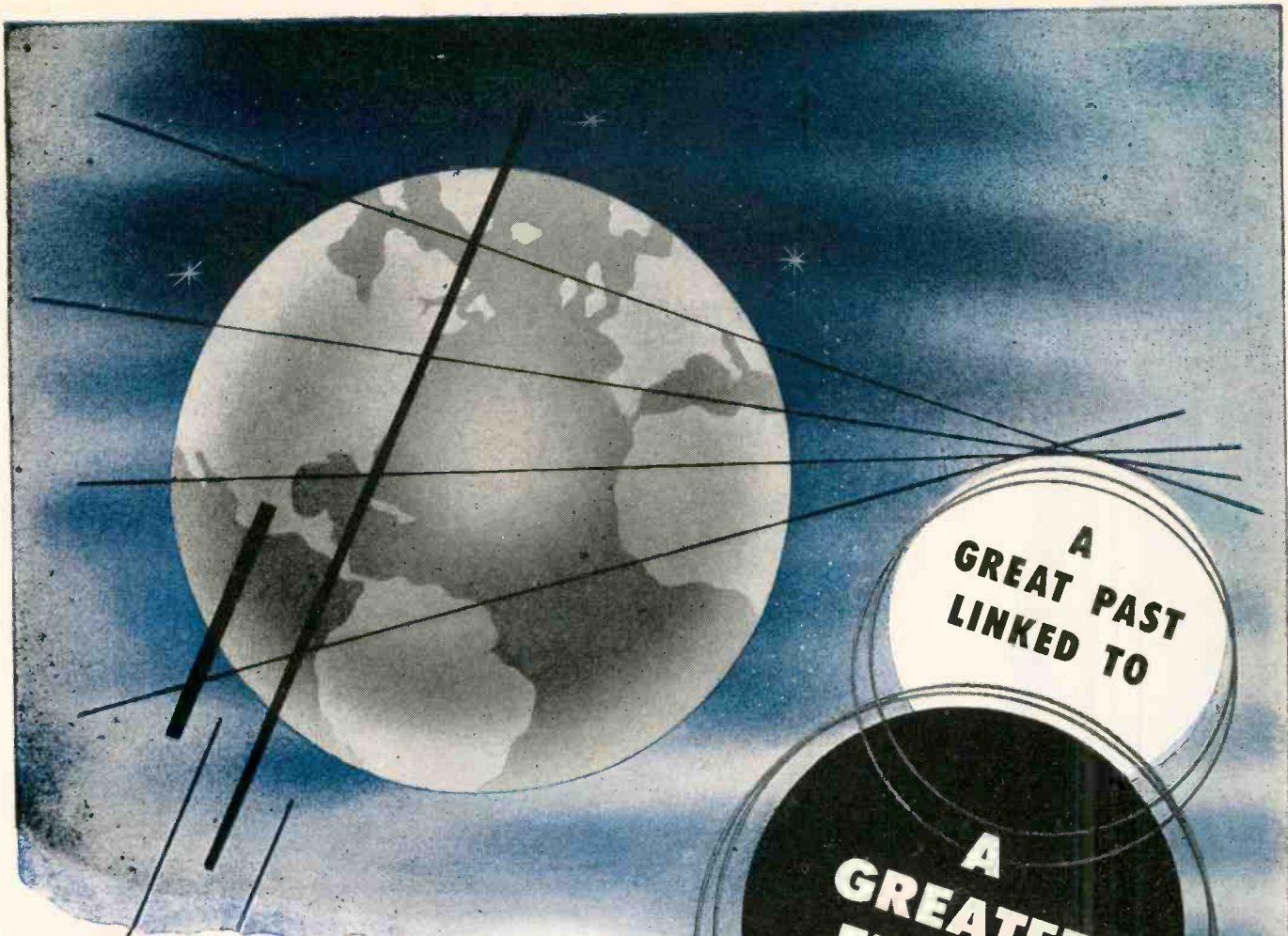

A  
GREAT PAST  
LINKED TO

A  
GREATER  
FUTURE  
1895 - 1945

# THORDARSON

*celebrates its 50th Anniversary  
by joining hands with*

## MAGUIRE INDUSTRIES

Throughout the past half century, the name "THORDARSON" has been a synonym for highest quality in transformers and other electrical equipment.

Under the banner of Maguire Industries, this tradition of leadership will be maintained in even fuller measure.

Thordarson's new plans include outstanding improvements in present lines... new products and services to meet the expanding needs of the radio and electronic industries... vigorous and liberal merchandising policies... and a generally forward-looking viewpoint with regard to all of the industries we are privileged to serve.



*A Subsidiary of Maguire Industries*

**THORDARSON**  
ELECTRIC MFG. COMPANY  
500 WEST HURON STREET  
CHICAGO 10, ILLINOIS

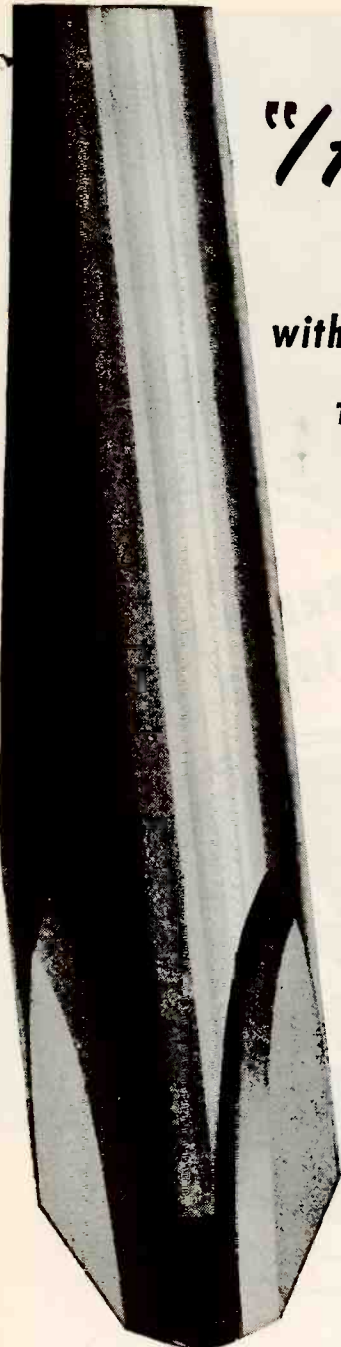

*"I Finish More Work  
by Noon*

with **AMERICAN PHILLIPS SCREWS**

**THAN I DID IN A WHOLE DAY  
WITH SLOTTED SCREWS!"**

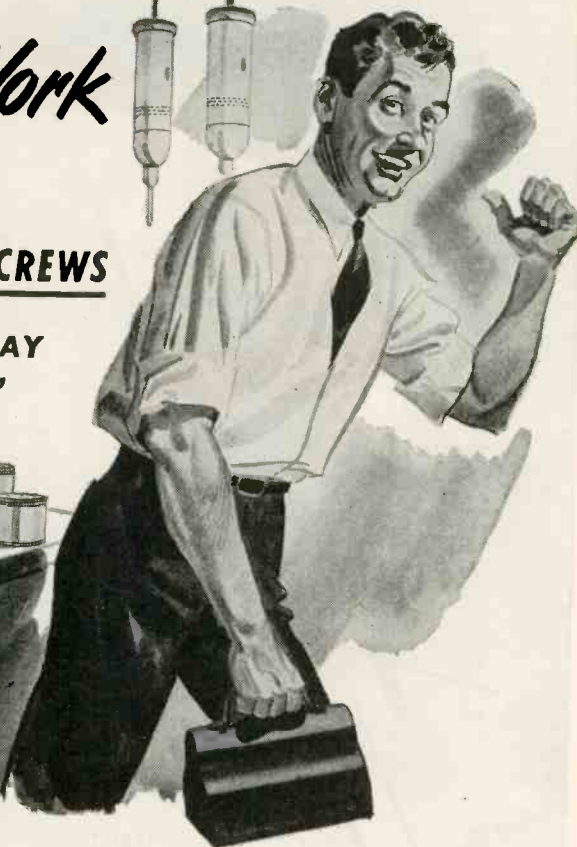
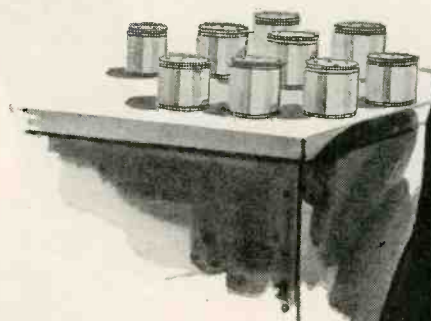

**50% FASTER** . . . that's the average speed-increase wherever modern American Phillips Screws replace outdated slotted screws. And that's because American Phillips Screws prevent driver-slippage, which means power drivers can be used on any job. So these straight-driving, fumbleproof screws take the brakes off your workers' hands, and the strain off their nerves and muscles. Self-confidence and pride in work is built up . . . and so is output and product quality, for there's no more scarred

work or burred, broken screw heads. Time-savings alone are enough to make American Phillips Screws least costly to use on any assembly job in small shop or big plant. But there's another saving that comes from American's own system of quality control and individual 3-point inspection that give you higher "perfection-percentage" in every order. Try American Phillips Screws yourself . . . and see what happens to what you thought were *fixed costs!*

**AMERICAN SCREW COMPANY, PROVIDENCE 1, RHODE ISLAND**

Chicago 11: 389 E. Illinois Street

Detroit 2: 502 Stephenson Building



**AMERICAN  
PHILLIPS** *Screws*

PUT THE SCREWS  
ON THE JAPS . . .  
BUY WAR BONDS

# HIGH VACUUM NOW CONTROLLED TO ONE-BILLIONTH OF AN ATMOSPHERE

**H**IGH on the list of important recent electron tube developments in the National Union Research Laboratories is this ultra sensitive N. U. Ionization Gauge.

Used as a control device in the evacuation of other electron tubes, this gauge reads pressures of .00001 of a micron! High vacuum is assured with resulting uniform high performance characteristics of all N. U. Tubes it helps to manufacture.

Having no grid element, this gauge is completely free from Barkhausen oscillations. Construction is simple, rugged, dependable—and, of course, economical to manufacture.

Here again is an example of the many contributions National Union engineers are making to the advance of electronics. For progress through research—count on National Union. *National Union Radio Corporation, Newark 2, New Jersey.*

## N. U. IONIZATION GAUGE

### Typical Operation

- Filament voltage—3.0 volts      • Filament current—1.8 A.
- Electron collector voltage—13 volts      • Electron current—20 Ma.
  - Ion collector voltage—200 volts
- Sensitivity—Ten times the ion current in amperes equals the pressure in mms. of mercury.

*It is possible to expose the hot filament of this gauge to air at atmospheric pressure and later have it function efficiently under vacuum conditions.*



# NATIONAL UNION RADIO AND ELECTRON TUBES

*Transmitting, Cathode Ray, Receiving, Special Purpose Tubes • Condensers • Volume Controls • Photo Electric Cells • Panel Lamps • Flashlight Bulbs*

# Announcing C.T.C.'s NEW TIME-SAVING All-Set TERMINAL BOARDS

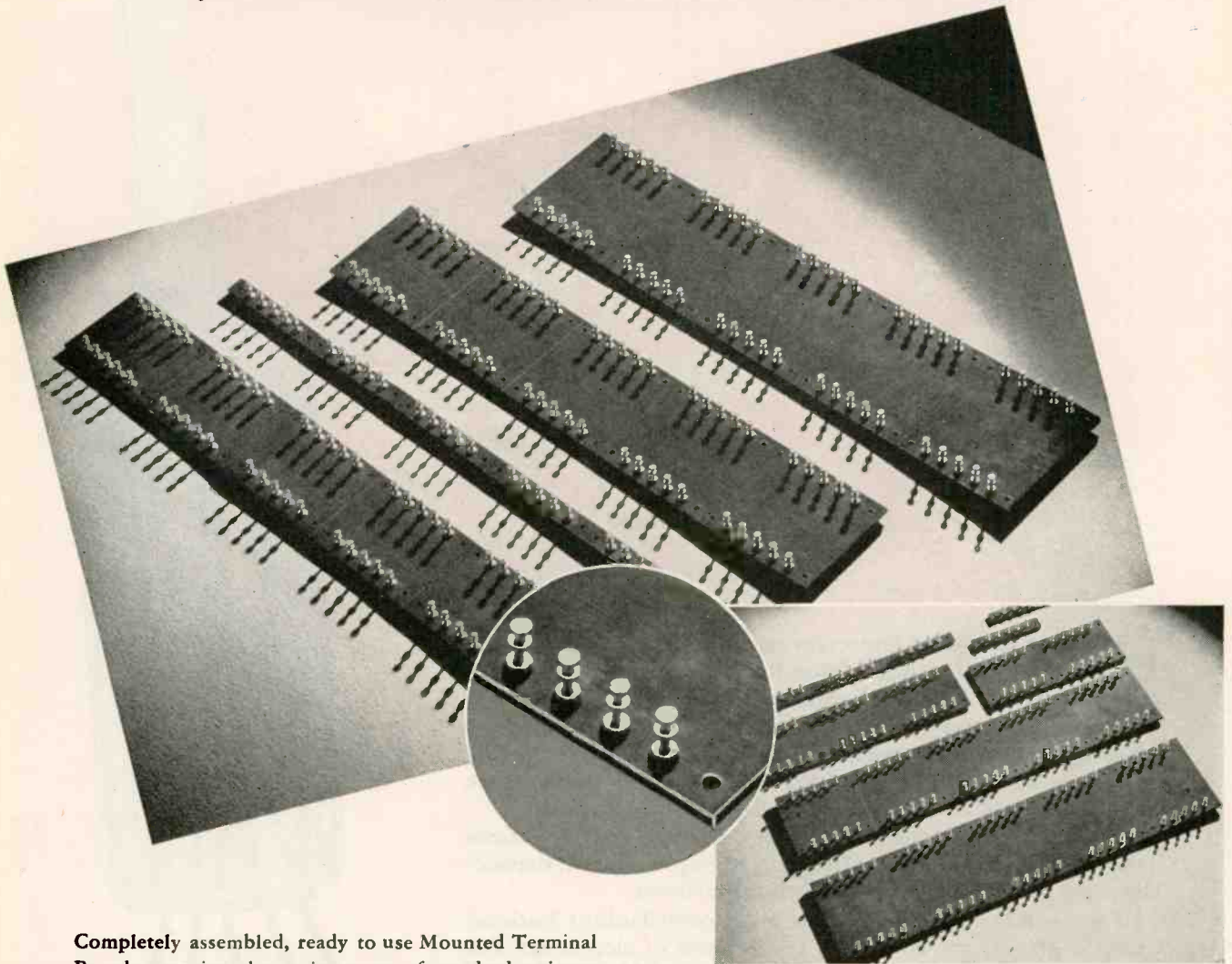

Completely assembled, ready to use Mounted Terminal Boards covering the entire range of standard resistors and condensers. Specially designed by C.T.C. for experimental laboratories and manufacturers to speed the development of model equipment and the assembly of established products.

These new C.T.C. Mounted Terminal Boards are made of  $3/32$ ",  $1/8$ " and  $3/16$ " linen bakelite only and are available in four widths— $3$ ",  $2\frac{1}{2}$ ",  $2$ " and  $7/16$ ".

They are made in five-section boards which can be broken into fifths by inserting in a vise and bending back on a

scribed line. Each fifth is drilled for twelve lugs. C.T.C. All-Set Terminal Boards are available in sets of four widths, or in lots of 6 or multiples of 6 in any single width. Extra lugs and stand-offs supplied.

C.T.C.'s new All-Set Terminal Boards can be supplied with any size C.T.C. Turret Terminal Lug—as listed in catalog #100, drawing #1724.

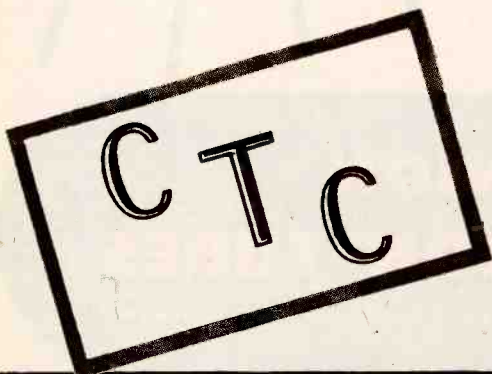

WRITE FOR C.T.C. CATALOG No. 100. It contains complete information on C.T.C.'s new ALL-SET Terminal Boards, Terminal Lugs and other C.T.C. components. It's yours for the asking.



**CAMBRIDGE THERMIONIC CORPORATION**  
439 CONCORD AVENUE, CAMBRIDGE 38, MASS.

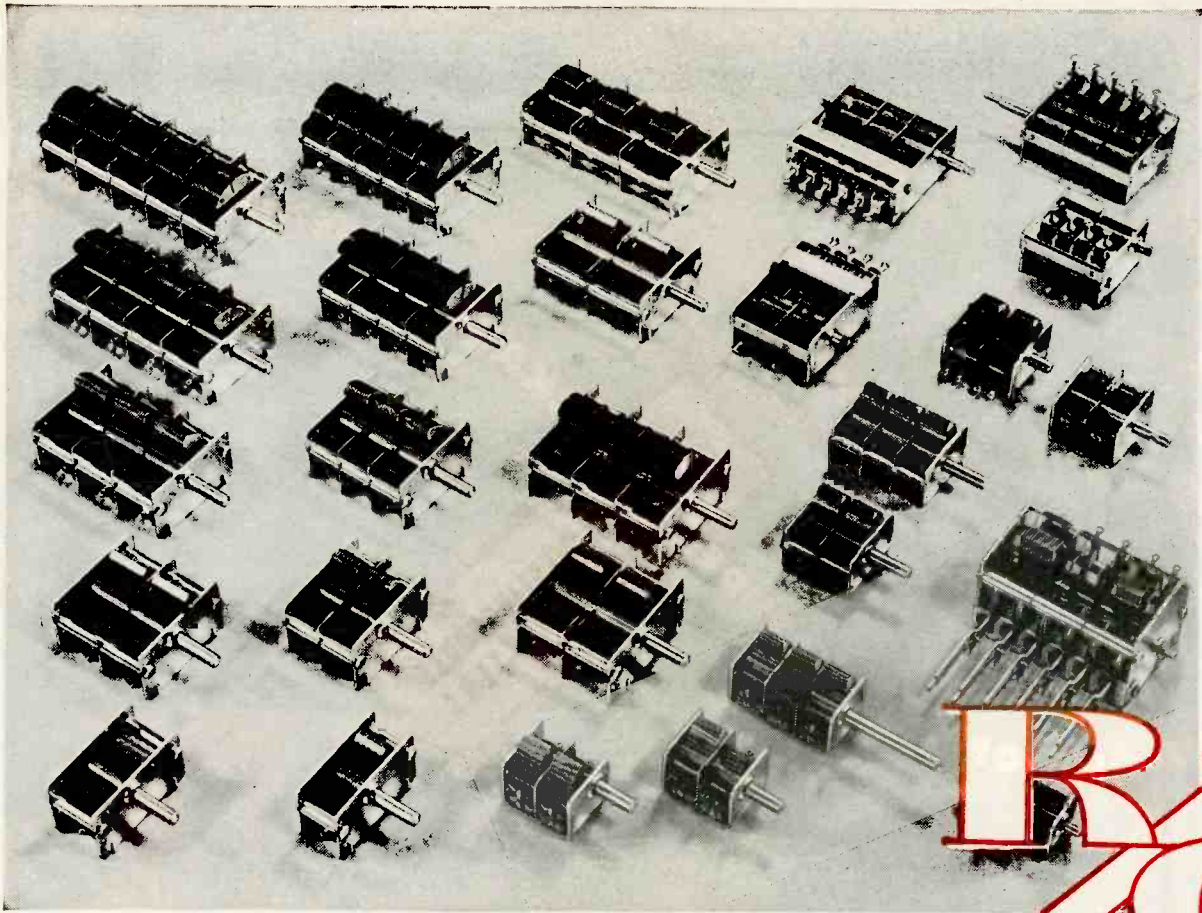

**R/C**

## WHEN YOU GET TO THE *VARIABLE CAPACITOR*

**NO** component today is more important than the tuning unit. On it, to a large extent depends your over-all design and, consequently, the essential sales features of your product.

And whether your call is for a variable capacitor or a complex tuning assembly, R/C can offer more and better informed help than you can obtain from any other source. Here you will find an unsurpassed wealth of specialized tuning unit experience at your disposal—dozens of standard types from which to choose—and facilities for the design, engineering and quantity production of any special unit that may be required.

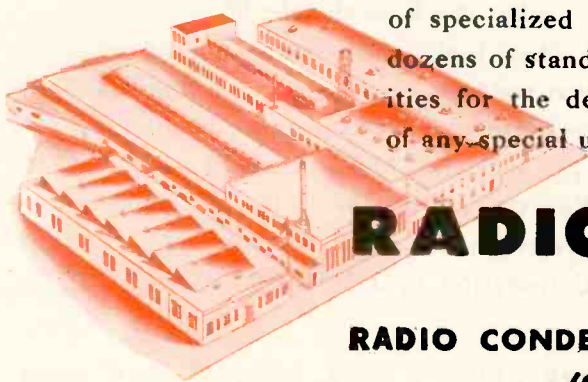

**RADIO CONDENSER CO.**

CAMDEN, N. J.

RADIO CONDENSER COMPANY LTD., TORONTO, CANADA

*(Suppliers to Set Manufacturers)*

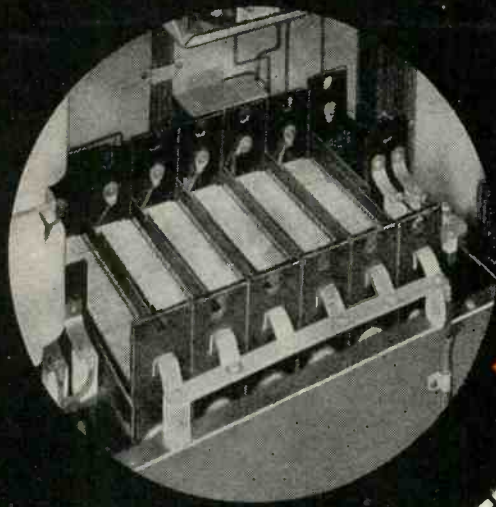

HERE'S ONE OF THE FEATURES OF PACKAGED DEPENDABILITY

IN WESTINGHOUSE TRANSMITTERS

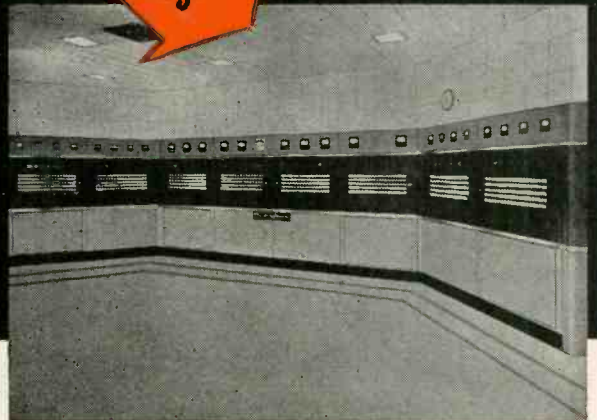

Dependability in transmitter performance is a package of many features . . . and one which contributes heavily to program continuity in Westinghouse 50-kw transmitters is the use of metal-plate rectifiers.

With virtually unlimited life, these surge-proof rectifiers have cut tube replacement to a new low, for only the power amplifier and modulator utilize tube rectifiers. Dependable performance is reinforced by quick tube transfer for emergency tube replacement.

Westinghouse 50,000-watt transmitters offer other advantages for clear channel service:

The smartly-styled Westinghouse 50-kw transmitters are built with 12 new, important design features. Ask your nearest Westinghouse office for the complete story.

*Example:* the equalized audio feedback system strengthens the naturally high fidelity of the audio and modulation circuits. No complicated circuit adjustments are needed.

*Example:* "De-ion" circuit breakers supply full overload and undervoltage protection, automatically reduce outage time.

*Example:* a tube life-meter provides a constant check on all tube life.

These basic advantages in faithful reproduction and solid dependability are features of the complete line of Westinghouse transmitters . . . 5, 10 and 50-kw AM, and 1, 3, 10 and 50-kw FM. You can get all the facts from your nearest Westinghouse office. Westinghouse Electric Corporation, P. O. Box 868, Pittsburgh 30, Pa.

J-08111

**Westinghouse**  
PLANTS IN 25 CITIES . . . OFFICES EVERYWHERE

*Electronics at Work*



**XXV RADIO'S 25TH ANNIVERSARY KDKA**



**one step**  
*Nearer...*

Smashing the Swastika does not mean total Victory. There is still the Rising Sun to be taken care of . . . But the victory in Europe is one step nearer to conversion to peacetime pursuits.

Here at JENSEN total conversion will be merely a matter of continuing to produce outstanding improved, high quality acoustic equipment. This is a continuing tradition at JENSEN. One example of advancement will be JENSEN Loud Speakers with *ALNICO 5*.



**Jensen**  
SPEAKERS WITH

**ALNICO 5**

*Specialists in Design and Manufacture of Acoustic Equipment*

JENSEN RADIO MANUFACTURING COMPANY, 4601 SOUTH LARAMIE AVENUE, CHICAGO, ILL.

# FIT THE RELAY TO THE JOB....

**NOT THE JOB TO THE RELAY**

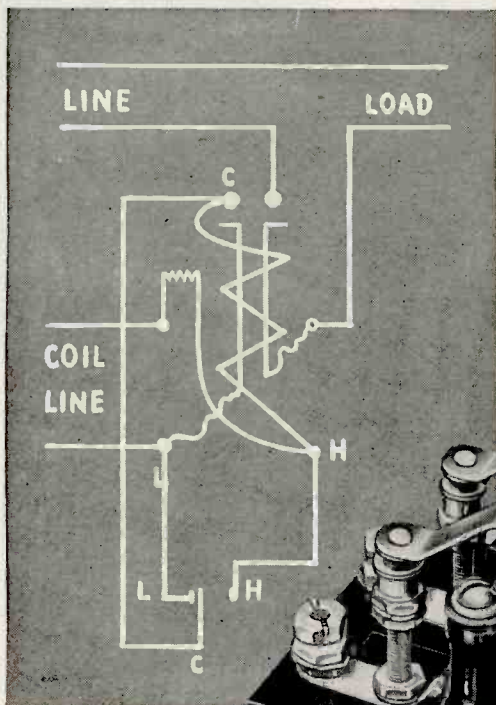

It's real economy to use relays that are *exactly* suited physically, electrically, and mechanically to your application—and it is Struthers-Dunn's business to supply just the unit you need. Today's list totals over 5,312 standard Struthers-Dunn types. Each is adaptable to numerous coil and design variations . . . but, should it still prove impossible to match your specification from this list, Struthers-Dunn engineers welcome the opportunity to "tailor" a new relay type to your exact measure.

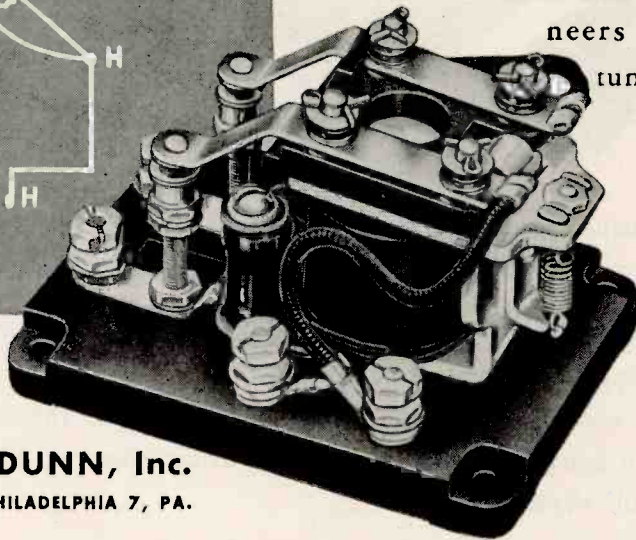

A typical application of the Struthers-Dunn Type 8BXX50 electrical lock-in relay used with a 3-wire "high-low" temperature control thermostat.

**STRUTHERS-DUNN, Inc.**

1321 ARCH STREET, PHILADELPHIA 7, PA.

# STRUTHERS-DUNN

## 5,312 RELAY TYPES

DISTRICT ENGINEERING OFFICES: ATLANTA • BALTIMORE • BOSTON • BUFFALO • CHICAGO • CINCINNATI • CLEVELAND • DALLAS • DENVER • DETROIT • HARTFORD • INDIANAPOLIS • LOS ANGELES • MINNEAPOLIS • MONTREAL • NEW YORK • PITTSBURGH • ST. LOUIS • SAN FRANCISCO • SEATTLE • SYRACUSE • TORONTO



# INSTRUMENT OF THE NEW INDUSTRIAL REVOLUTION

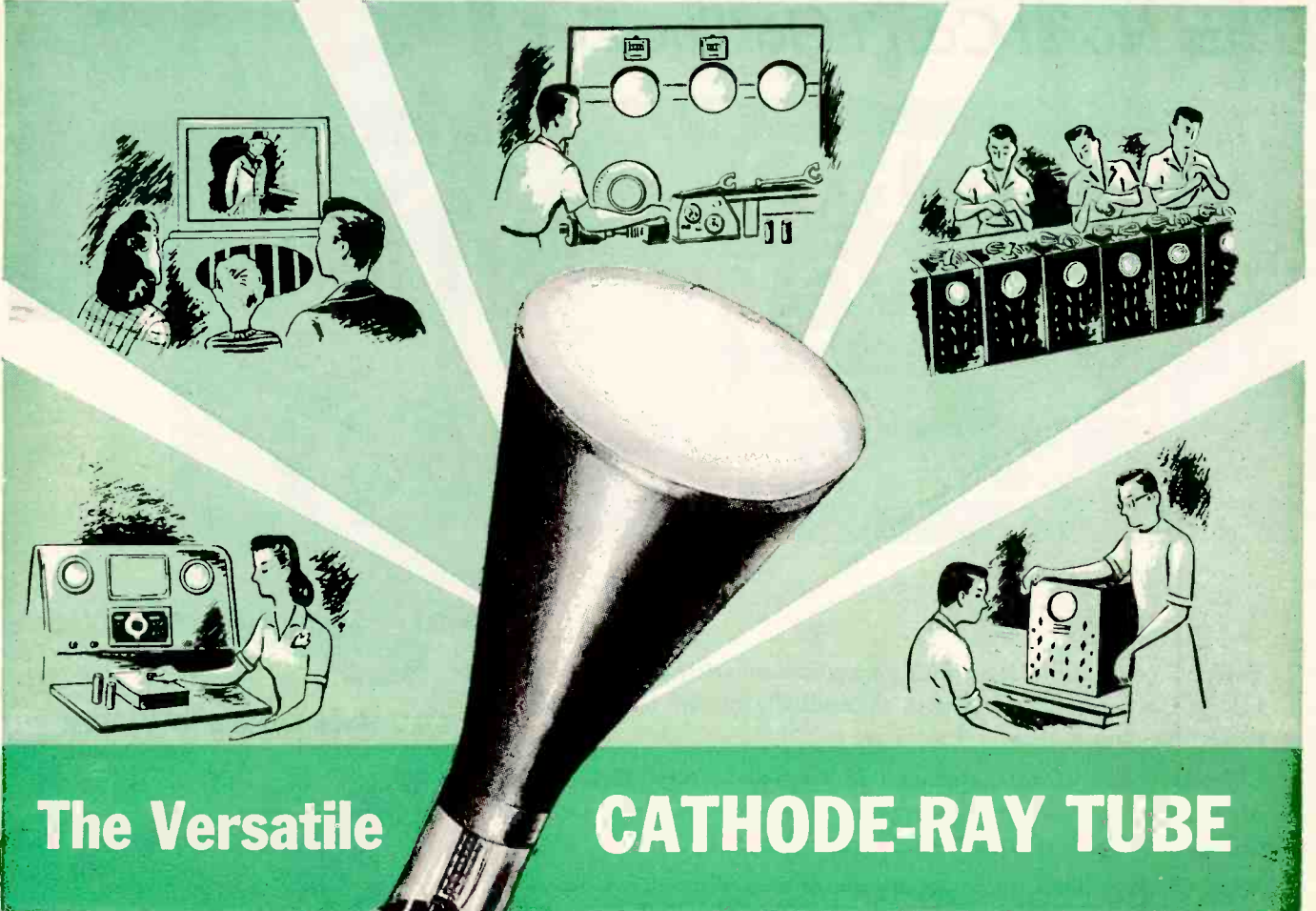

The Versatile

CATHODE-RAY TUBE

Among the more important applications of the Cathode-Ray Tube are the following:

**TELEVISION**

- Kinescope — Iconoscopes
- Monitors for television signals

**ELECTRICAL**

**LABORATORY**

**PRECISION**

**MEASUREMENTS**

- Oscilloscopes
- Comparison of Wave Shapes
- Frequency Response
- Power Distortions

**MEDICAL**

- Electrocardiograph
- Reaction of nerve stimuli

**MECHANICAL**

- Measurement and visual indication of Tension
- Stress analysis
- Compression of engines
- Vibrations
- Uniformity of gear cuts, rams, etc.
- Regulation of spring movements

**GENERAL**

- Musical tones study
- Measuring efficiency of operations
- Speed measurements

The part that the cathode-ray tube is destined to play in the industrial picture of tomorrow is dramatically suggested in its wartime applications.

The term "picture" is used advisedly. For the performance of the cathode-ray tube is pictorial. Thanks to its magical powers, hidden secrets are made to materialize . . . elusive phenomena are captured and crystallized so that they may be viewed and studied.

Today, the cathode-ray tube is a weapon of war. In the tomorrow of peacetime progress, it will demonstrate its versatility in industry, in medicine, in countless

fields, and in wondrous ways . . .

As manufacturers of electronic testing equipment, we of Sherron Electronics have a first-hand familiarity with cathode-ray tubes.

In our research and development departments, we have produced equipment for the inspection of the cathode-ray tube, as well as equipment in which the cathode-ray tube has served as a measuring device.

Already, the cathode-ray tube figures importantly in the postwar projects of many manufacturers. For information regarding the adaptability of the cathode-ray tube to your own manufacturing processes, write to:

*Sherron  
Electronics*

**SHERRON ELECTRONICS CO.**

*Division of Sherron Metallic Corporation*

1201 FLUSHING AVENUE, BROOKLYN 6, N. Y.

"Where The Ideal Is The Standard, Sherron Units Are Standard Equipment"

# This Hoist Can't Go Too Far

## MICRO SWITCH

SNAP-ACTION

Takes Care of That

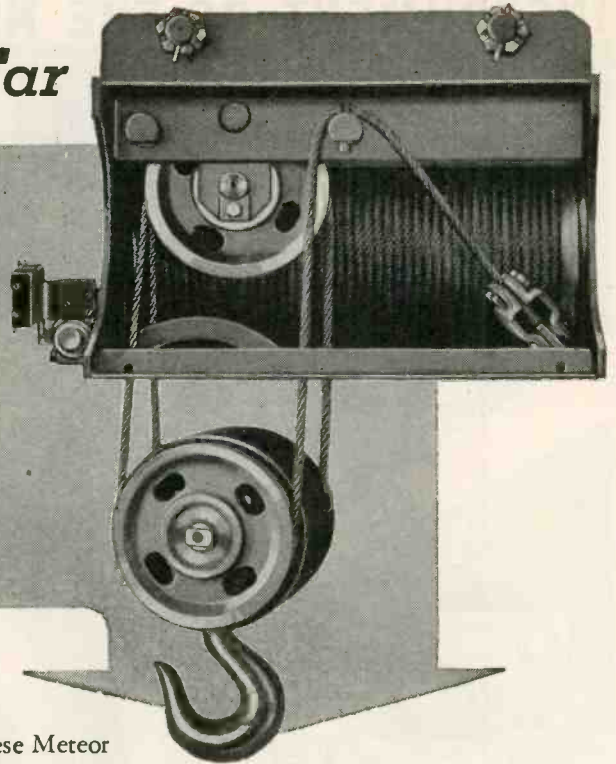

There's a limit to how far a hoisting operation can safely go. These Meteor Electric Hoists protect themselves automatically, should the operator fail to stop the hoist in time.

Chisholm-Moore Hoist Corporation of Tonawanda, New York, use two Micro Switch snap-action switches in the safety limit which make it impossible to jam the lower hook block into the drum.

When the hook block reaches its uppermost limit of travel, it raises a limit lever. This is mechanically connected to the two Micro Switch snap-action switches which break the pilot circuit, stop the flow of current to the motor, and apply a quick-acting motor brake.

These streamlined Meteor Electric Hoists, backed by 50 years of hoist building experience, make use of Micro Switch products in a design which utilizes all space to advantage . . . avoids all cumbersome bulk and excess weight.

This use of these dependable, long-lived, snap-action switches is typical of the increasing use which every branch of industry is finding for Micro Switch products. In some applications their sensitivity, the small operating force and small travel required to operate them are important. In other applications the ability of these tiny switches to handle substantial amounts of power at line voltages without the use of relays is of prime importance. Their millions of accurate repeat operations make these switches valuable components of the highest type of industrial products.

### Here is How It Works

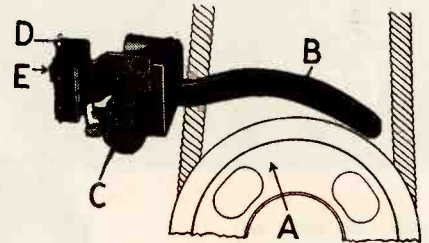

Two roller lever actuated switches are used.

When hook block "A" reaches the uppermost point of travel it strikes lever "B" which is connected by a shaft to cams "C". One cam is set slightly ahead of the other in order that one switch may be operated first.

Operation of switch "D" opens the pilot circuit of the hoisting motor. Should the gear train continue to move in excess of a predetermined amount, the second cam operates switch "E" which closes the lowering pilot circuit, momentarily reversing the motor. This lowering circuit is again opened as soon as the hook is lowered a small amount.

#### DO YOU NEED A SWITCH TO...

control temperatures, help to package products, bottle fluids, record airplane flights, make change, dispense drinks, heat water, control electronic tubes, or steer ships? Micro Switch snap-action switches successfully control many such operations . . . and thousands more. Micro Switch engineers, experienced in the application of millions of these precise, snap-action switches to products for both war and peace, will be glad to show you how they can add long life and reliability to your product at lower cost. Write for the Micro Switch Handbook-Catalog today.

LET'S ALL BACK THE ATTACK

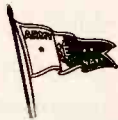

BUY EXTRA WAR BONDS

© First Industrial Corporation



The basic switch is a thumb-size, feather-light, plastic enclosed, precision, snap-action switch, underwriters' listed and rated at 1200 V. A., at 125 to 460 volts a.c. Capacity on d.c. depends on load characteristics. Accurate reproducibility of performance is maintained over millions of operations. Basic switches of different characteristics are combined with various actuators and metal housings to meet a wide range of requirements.

Basic switches of different characteristics are combined with various actuators and metal housings to meet a wide range of requirements.

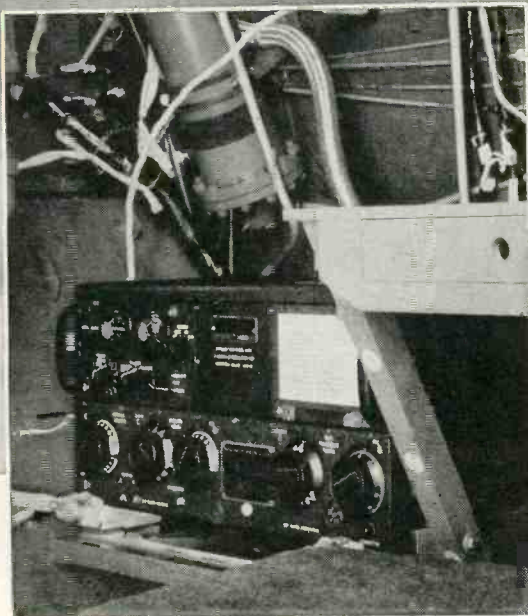
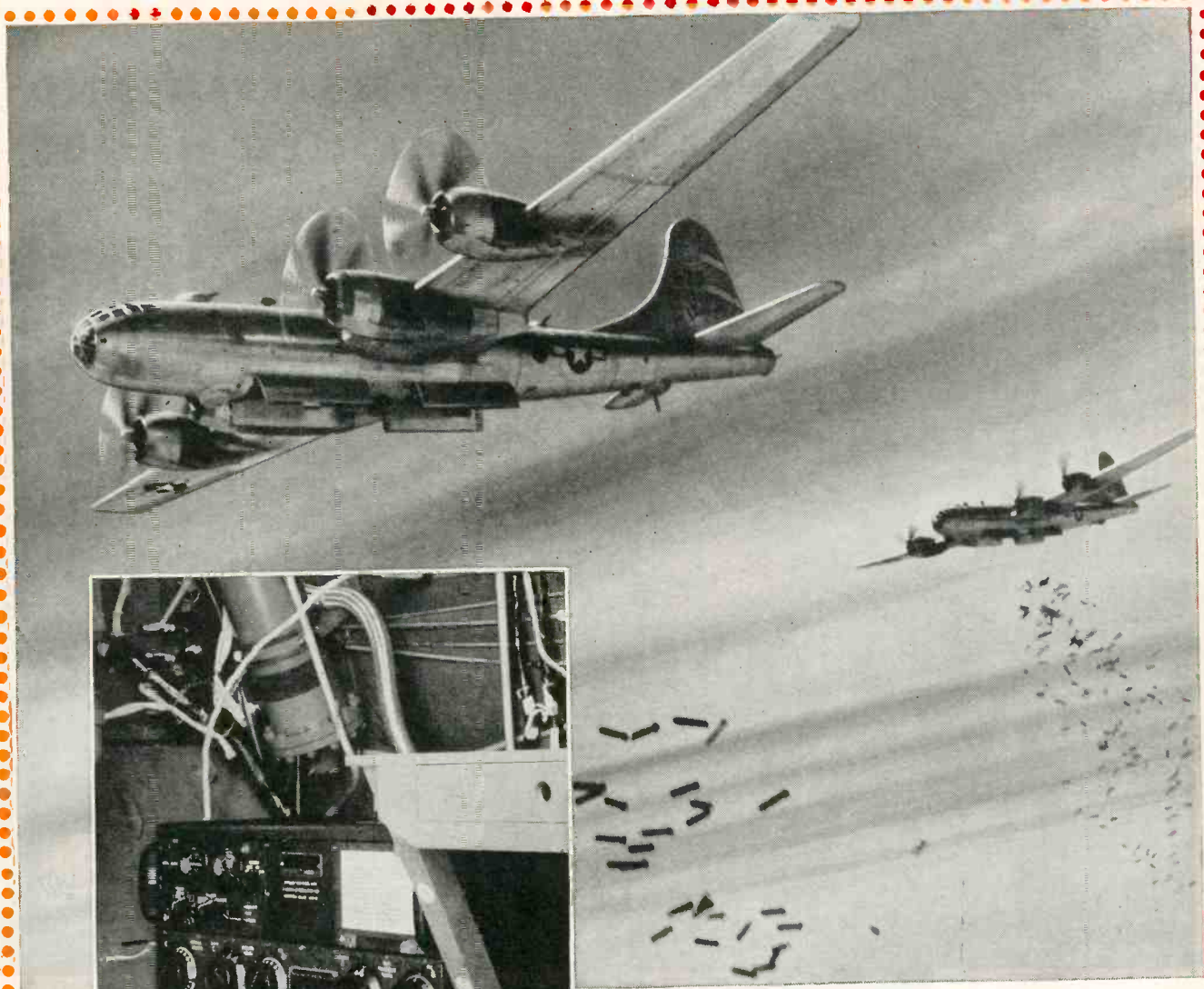

The Collins-designed transmitter as operator sees it from his station in a Superfortress. Boeing—Wichita Photo.

Superfortresses blast and roast Japs. Official photo U.S.A.F.

## In the Boeing B-29 from the first

THE FIRST MESSAGE from the Army's first Boeing Superfortresses over Japan, on the Yawata mission of June 15, 1944, was transmitted by a Collins radio transmitter of the type shown above. From that time on, this transmitter has been standard equipment for all the Superforts, as it is also for the larger Naval aircraft.

As the Army and Navy demand increased, requirements exceeded the capacity of the extensive Collins facilities, and other manufacturers of radio equipment were drawn into the production program, aided by Collins engineers. Total deliveries have been very large.

Collins engineering and production have gained much valuable experience during the war in providing reliable radio communications under all operating conditions in practically every quarter of the globe. This experience will be available to commercial and personal users as soon as military requirements permit. Collins Radio Company, Cedar Rapids, Iowa; 11 West 42nd Street, New York 18, N. Y.



IN RADIO COMMUNICATIONS, IT'S . . .



*Precision Methods  
Followed*

**BY SKILLED AND  
TRAINED HANDS**

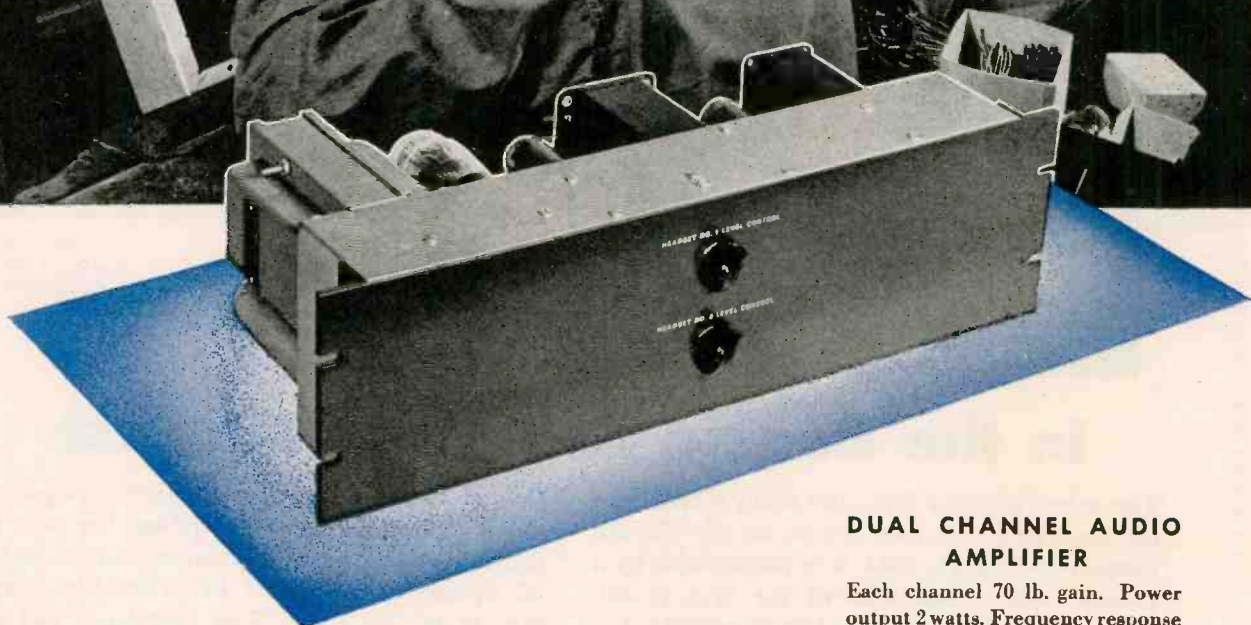

**DUAL CHANNEL AUDIO  
AMPLIFIER**

Each channel 70 db. gain. Power  
output 2 watts. Frequency response  
200-7000 cycles.

For precision radio communications equipment, precision manufacturing is imperative. The equipment produced by Wilcox has reached a new standard of perfection for war-time communications and from this vast experience have come many new developments now being incorporated into post-war designs. Many items in this expanded and improved line are now available, subject to military priorities. Your inquiries invited.

**WILCOX ELECTRIC COMPANY, INC.**

*Manufacturers of Radio Equipment*

**FOURTEENTH AND CHESTNUT**

**KANSAS CITY, MISSOURI**



# The Secret of Nichrome\* Superiority

## Metallurgical Control from Furnace to Spool

To produce genuine Nichrome takes more than the combining of the two metals Nickel and Chromium. It requires highly specialized techniques to make this superior heat and oxidation resisting alloy.

Step-by-step through every stage of manufacture, from the first melting of the metals to the final spooling of the finished wire, precise metallurgical checks and controls operate to assure the peerless quality of Nichrome.

These exclusive Driver-Harris quality controls represent 45 years of continuous alloy research. No wonder, therefore, that Nichrome is the time-tested standard by which other electrical resistance alloys are measured. Although there are many excellent nickel chromium combinations there is *only one Nichrome* . . . and it is made *only* by Driver-Harris.

For full technical information regarding D-H Nichrome write for Data Book R-42.

NICHROME is made only

by



Trade Mark Reg.  
J. S. Pat. Off.

**Driver-Harris**  
COMPANY  
HARRISON, N. J.

Branches: Chicago • Detroit • Cleveland  
Los Angeles • San Francisco • Seattle



M A S T E R S   O F   P R E C I S I O N

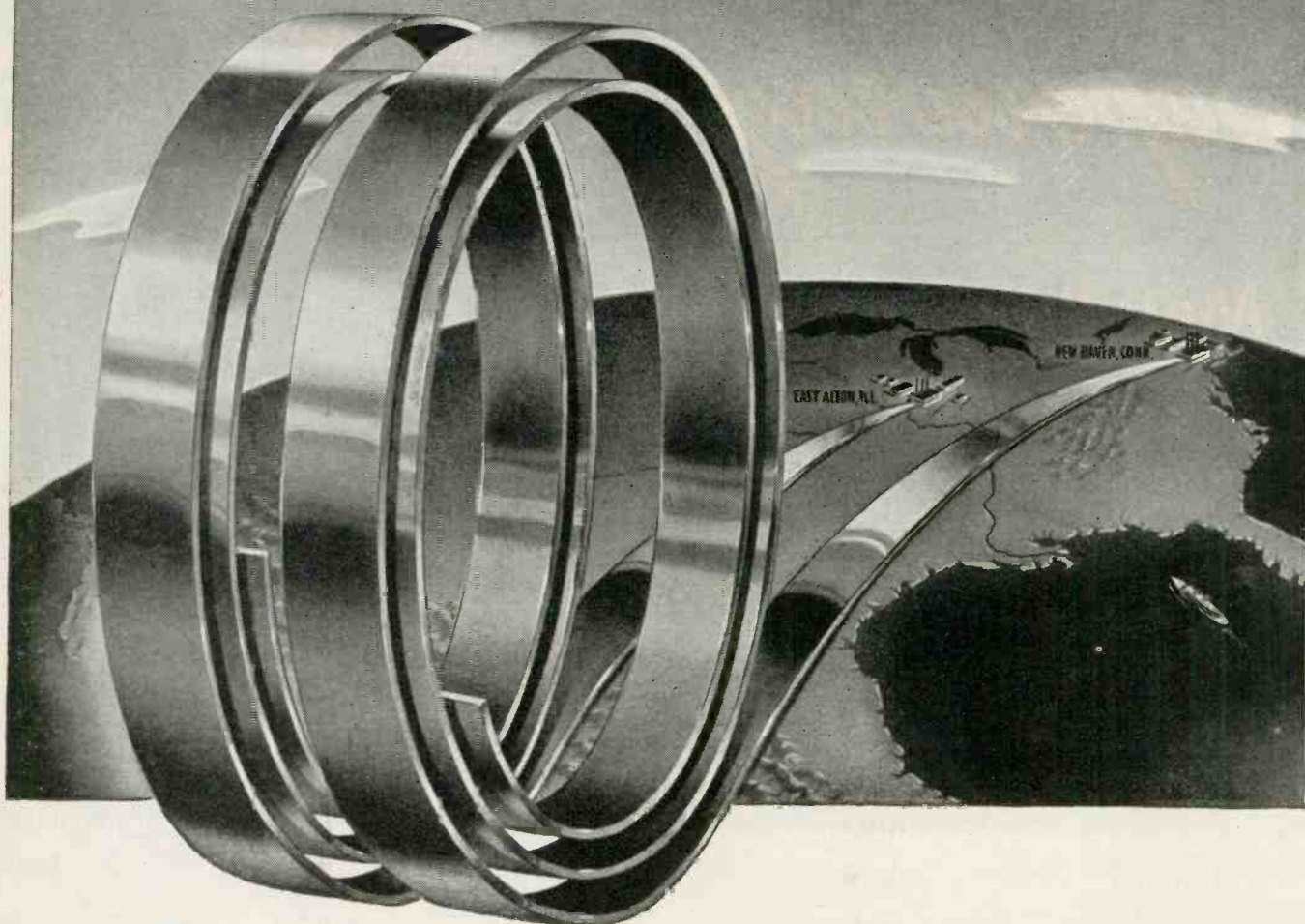

## Two Mills.. Supplying "Tailor-Made" Metals

Western mills at East Alton, Ill., and New Haven, Conn., are strategically situated to supply alloy metals to manufacturers throughout the country.

Both of these mills specialize in supplying metals made to rigid requirements. When close tolerances are a "must" we

meet the specifications. If your needs call for exacting tempers or finishes they are furnished as ordered.

We will welcome your inquiry regarding "tailor-made" metals . . . in sheet, strip, long coils or stamped parts.

# WESTERN BRASS MILLS

DIVISION OF OLIN INDUSTRIES, INC.

East Alton, Illinois



BRASS • BRONZE • PHOSPHOR BRONZE • NICKEL SILVER • COPPER

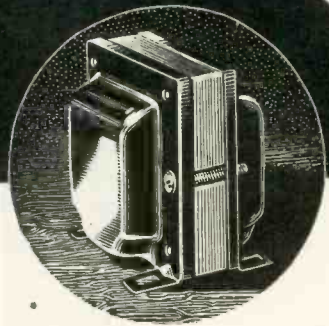

★ *This speaks for itself: Utah is its own transformer supplier for speakers, vibrators, wire recorders, etcetera.*

## WHEN UTAH SAYS... "OK-SHIP"

It's like putting a big liner into water. Like a launching. Only here at Utah, we don't take time for celebration. Radio makers and electronics dealers appreciate the highly specialized product that has been manufactured the way a skipper appreciates a fine craft. Radio listeners, like ships' passengers, take all this precision for granted.

Here at Utah our workers (assisted by



Utalins\*) begin with nothing but the raw materials from which they make the tools that turn out Utah radio parts and electronic devices. At each step in manufacture . . . punch press, electroplating, welding, coil winding . . . from the beginning through to the finished product, Utah workers check, re-check, test and prove to Utah standards. When Utah says... "OK-SHIP" products of quality that stand up under every condition known to man leave to broadcast Utah performance around the world.

\*Utah's Helpers

**UTAH RADIO PRODUCTS COMPANY, 820 ORLEANS ST., CHICAGO 10, ILL.,**  
*Utah Electronics (Canada) Ltd., 300 Chambly Road, Longueuil, Montreal (23) P.O. • Ucoa Radio, S.A., Misiones 48, Buenos Aires*

# SYLVANIA NEWS

ELECTRONIC EQUIPMENT EDITION

JULY

Published by SYLVANIA ELECTRIC PRODUCTS INC., Emporium, Pa.

1945

## NEW TUBE HAS SEPARATE CATHODES

*Construction Permits Use As A Discriminator*

Sylvania Type 7K7 is a duo-diode high- $\mu$  triode differing from the usual diode-triode by having two separate cathodes, one for the triode and the other for the diodes.

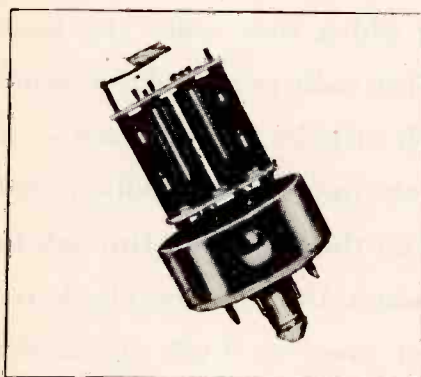
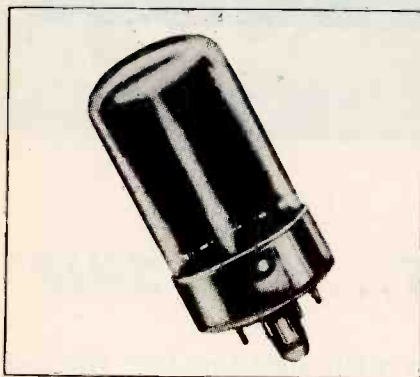

This difference permits the tube to be used as a discriminator.

The cut-away view shows that although the construction looks like a duo-triode the second plate is really a shield around the two diodes.

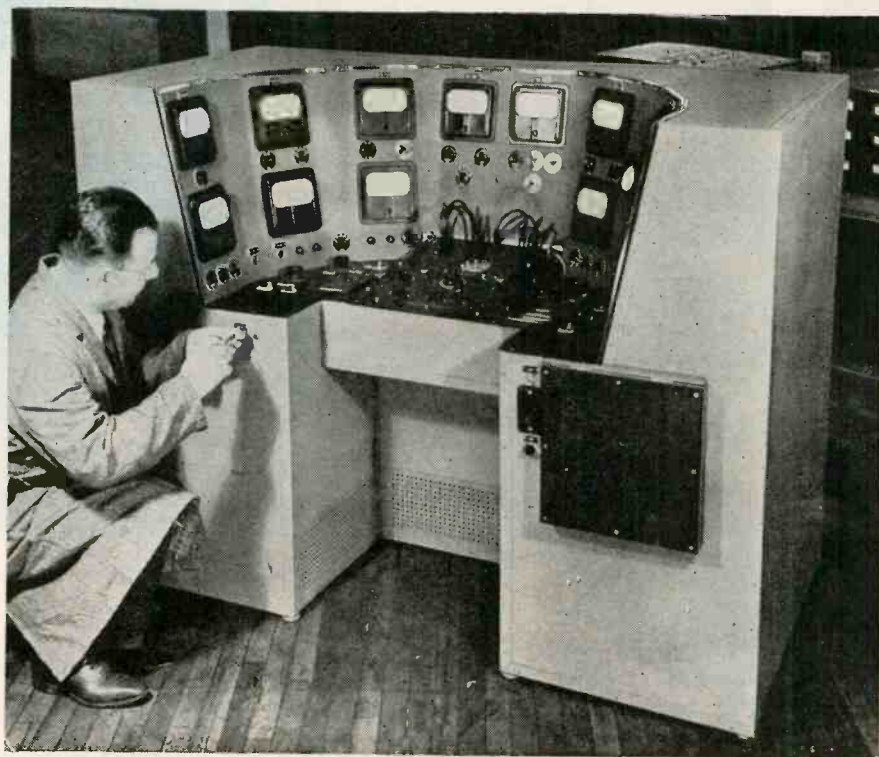

## SYLVANIA RADIO TUBE BRIDGE SET INSURES PERFECT PERFORMANCE

*Measures Static And Dynamic Characteristics Of Vacuum Tubes*

As ultra-high frequencies and a very wide range of intricate electronic applications make strict demands on tube performance and circuit designs, an accurate testing of tube and circuit characteristics becomes of the greatest importance.

One of Sylvania Electric's latest essential radio vacuum tube bridge test sets for precision engineering data is pictured above. Manufactured at Sylvania's plant at Williamsport, Pa., this equip-

ment measures static and dynamic qualities of radio tubes, such as plate current, filament voltage and current, screen current, gas current, plate resistance, power output, mutual conductance, and amplification factor, as well as the characteristics of electronic devices.

The set is compact, fully shielded, with well-filtered, self-contained power supplies, complete with voltage regulators except AC and DC filament voltages.

# SYLVANIA ELECTRIC

Emporium, Pa.

MAKERS OF RADIO TUBES; CATHODE RAY TUBES; ELECTRONIC DEVICES; FLUORESCENT LAMPS, FIXTURES, ACCESSORIES; ELECTRIC LIGHT BULBS



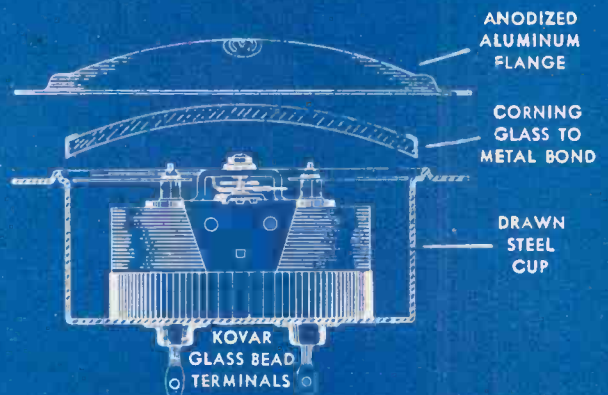

**YES!** They're totally sealed. The Marion design and glass-to-metal sealing process assure true hermetic sealing. And the bond between the metallized glass rim and the steel case is capable of withstanding extreme thermal shock.

**YES!** They're interchangeable. Magnetic shielding permits interchangeability on any type of panel without affecting calibration. The Type HM 2 is directly interchangeable with AWS Types MR 24 and 25. The Type HM 3 is directly interchangeable with AWS Types MR 34 and 35.

**YES!** They're priced right. As a matter of fact, Marion Glass-to-Metal Truly Hermetically Sealed Electrical Indicating Instruments cost no more than standard unsealed instruments — yet, they'll perform more satisfactorily over a longer period of time.

**YES!** They're a postwar potential. Because they afford complete protection against the effects of temperature and humidity, these instruments can simplify many production problems, particularly in regard to export sales. Call us. Our hermetic sealing experience may be of value to you.

## Marion Glass-to-Metal Truly Hermetically Sealed 2½" and 3½" Electrical Indicating Instruments

Write today for complete information. Not only do we offer these instruments in standard ranges, but we also specialize in supplying them with special and unusual characteristics for new and unusual applications.



MARION ELECTRICAL INSTRUMENT CO.  
MANCHESTER, NEW HAMPSHIRE

**HOW EXCELLENCE IS BUILT INTO**

# **Sangamo**

**MICA  
CAPACITORS**



• Vacuum impregnation tank and waxing equipment for special treatment of mica films.

**SANGAMO ELECTRIC**

• • • ESTABLISHED 1898 • • • MICA CAPACITORS • • •



## Cartridge IMPREGNATION

THE processing of the capacitor cartridge before moulding is a very important step in controlling the quality of the finished capacitor. Not only must all traces of air and moisture be removed from the cartridge, but the cartridge must also be treated to insure permanence of the desired characteristics, such as power factor and insulation resistance, when once these have been attained.

These conditions are achieved by subjecting the cartridges to a high degree of vacuum for the removal of moisture and air, and by impregnating them with moisture resistant waxes or varnishes, in special vacuum impregnating tanks. To assure that the prescribed electrical characteristics are obtained, various waxes and varnishes may be used. All excess wax is removed by centrifugal force so that it does not interfere with the proper moulding of the plastic case in the subsequent operation. The plastic case additionally seals the capacitor against atmospheric conditions, thus further contributing to the long, trouble-free life of capacitors in service.

By maintaining constant vigilance in each of the manufacturing processes, the Sangamo standard of excellence is assured for Sangamo Mica Capacitors.

• Impregnating and spinning equipment for vacuum wax impregnating mica capacitor cartridges and spinning off excess wax.



• Impregnating tank for vacuum impregnation of capacitors and capacitor cartridges.

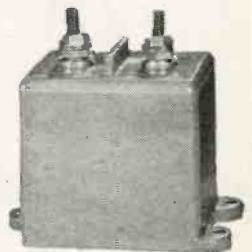
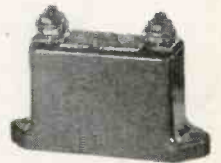
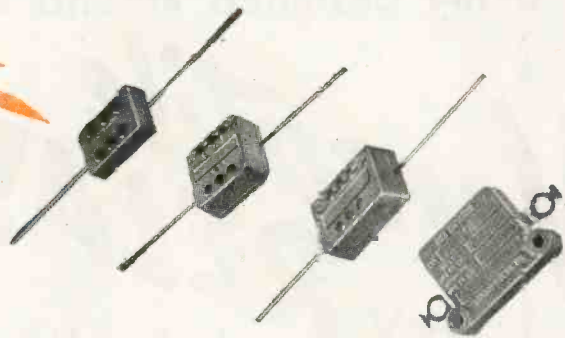

**COMPANY** SPRINGFIELD  
ILLINOIS

• • • WATT HOUR METERS • • • TIME SWITCHES • • •

Many Post War Products  
are being designed around this

# Versatile RELAY

ROTARY

that has achieved such  
outstanding performance in war  
Communications Equipment.

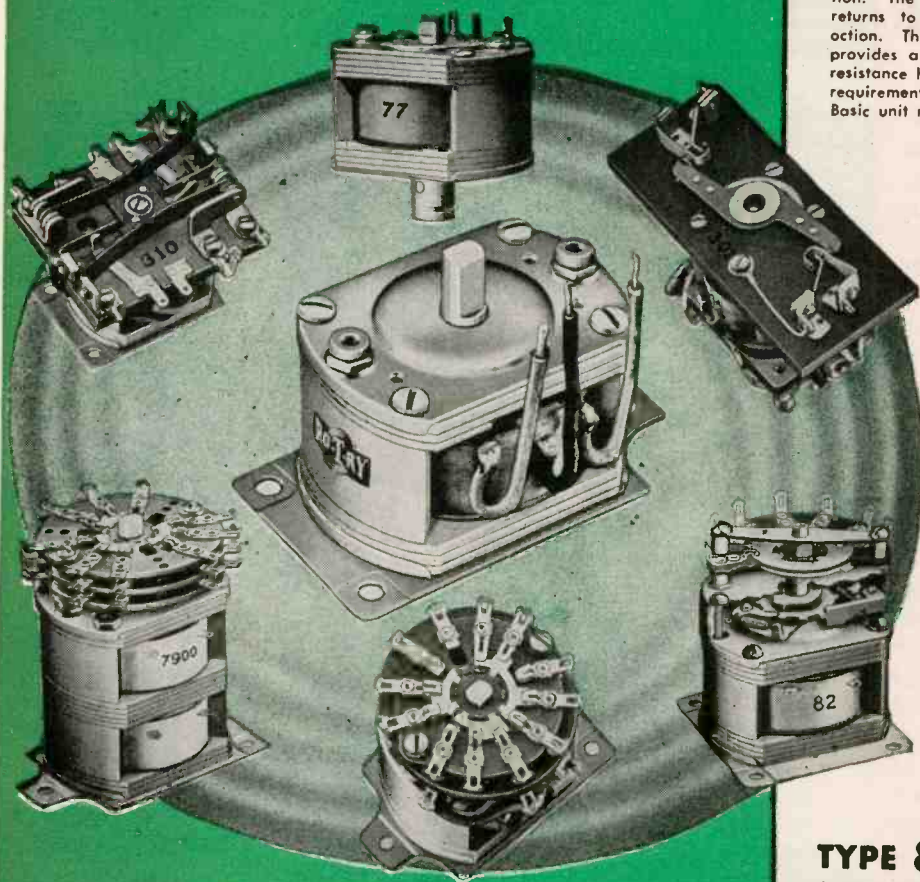

## Get Catalog E-75

Illustrates "RO-T-RY" adaptability to unusual and varied relay applications. Complete specifications and detail drawings. Also illustrates other Price Bros. Co. Relays for Time Delays, Motor Starting, High Speed Keying, Antenna and Power Contactors. Write today for this Catalog.

# RO-T-RY

## A NEW BASIC RELAY UNIT of Versatile Adaptability

RO-T-RY introduces a new basic principle of Relay operation especially designed to withstand severe vibration, temperature and humidity conditions. When used to operate switch wafers it provides a great variety of contact arrangements, a few of which are here shown.

**TYPE 76** This basic "RO-T-RY" (center photo) is a compact, two position driving mechanism providing up to 30 degrees of clock-wise or counter clock-wise rotation as specified from the normal (power-off) position. The shaft is rotated one way under power, and returns to the normal (power-off) position by spring action. This unit incorporates a two winding coil which provides a high initial torque, then switches in a high resistance holding winding which reduces the coil current requirements to a minimum in the energized position. Basic unit measures 2 1/2" x 1 1/2" x 1 3/4".

**TYPE 77** Designed to operate a shaft extension through 30 degrees rotation. In general this provides means of operating widely spaced wafer switches, or for operating them in separate compartments. A special coupling provides easy means of connecting to a separate shaft.

**TYPE 301** A keying relay providing instantaneous break in operation, in addition to other features. Extended shaft provides positive mechanical interlock between keyed circuits and switching of antenna from transmitter to receiver.

**TYPE 310** A special compact DP-DT and a SP-ST relay designed to meet standard aircraft vibration specifications. The unit is primarily designed as a motor generator control relay, with the DP-DT contacts rated at 40 amps. DC and the SP-ST contacts at 5 amps. DC.

**TYPE 7900** A Duplex Driving Mechanism for use where no spring return is needed, or provided. For momentary operation only. Develops 16 oz. in. Torque at minimum operating voltage. Provides positive driving power for multiple switching of "on-off" or "Set" "Reset" operations.

## TYPE 82 Stepping Unit

A compact 12 position driving mechanism which operates a shaft extension through 360° in 12 progressive steps. When built up as shown, the unit provides a 12 position selector switch which indexes one position for each momentary current impulse. The unit will drive up to three wafer switches or any other load not in excess of 8 1/2 ounce inches torque. 12 or 24 volt DC operation is standard. Other DC voltages available.



# PRICE Brothers Co. FREDERICK, MARYLAND

RELAYS, CONTROLS, AND MAGNETIC DEVICES FOR ELECTRONIC & INDUSTRIAL APPLICATION

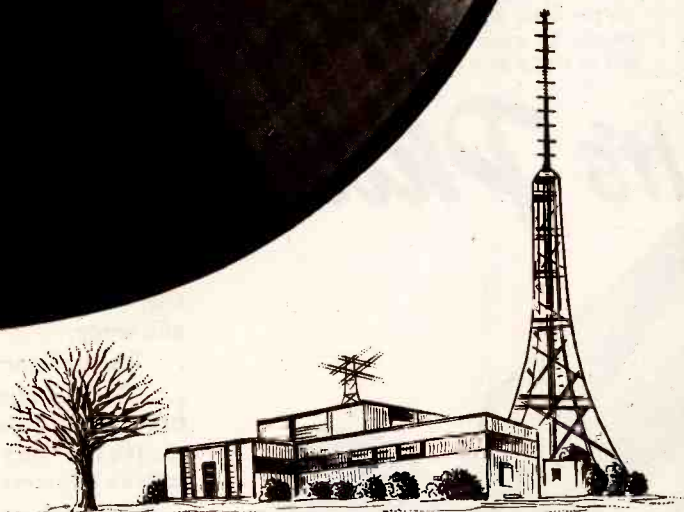

There are no finer recordings than those transcribed on

**audiodes**

AUDIO DEVICES INC. • 444 MADISON AVE., N. Y.



*they speak for themselves* **audiodes**



### SHUTS OUT SLIP-UPS!

Assembling baby furniture was mighty slow work with slotted screws, one manufacturer found. Too many scratches to refinish - scratches caused by driver skids. So to pick up production he switched to Phillips Screws...

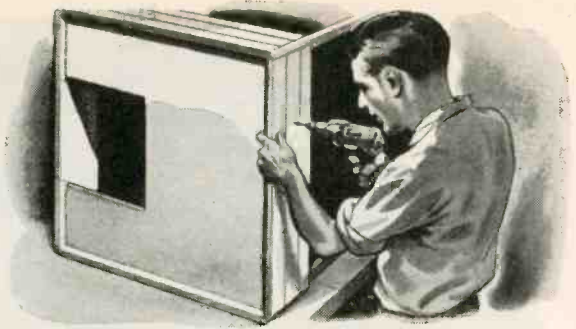

### FRIENDLY TO PROFITS!

... out went burred heads and driver skids and slant driven screws. Out went slow-as-molasses hand driving. In came power driving - and with it, savings in time and materials that sliced a big chunk off assembly costs.



### LONG ON SAFETY!

By making it stronger and more rigid, and by banishing dangerous burrs, Phillips Screws made this furniture safer for the kids. And your designers will find they do the same things for your product - whether it's tiny as a hearing aid or hefty as a harvester!



### TOUGH ON COMPETITION!

Because of the ornamental design of the recess, Phillips Recessed Head Screws impart a "quality look" to any product. They give you a burr-free, blemish-free job that tells prospects you're on your toes - and warns competitors to watch out for theirs!

# It's Phillips... the engineered recess!

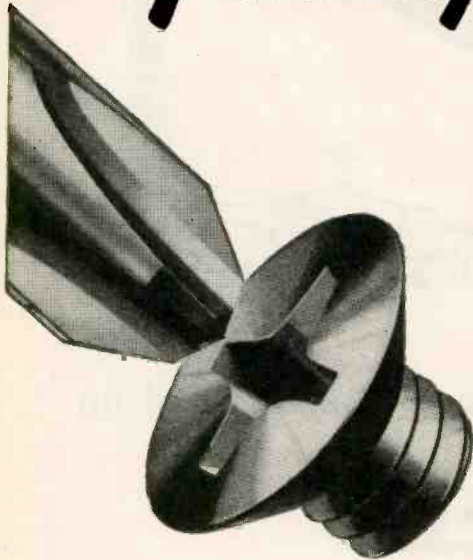

In the Phillips Recess, mechanical principles are so correctly applied that every angle, plane, and dimension contributes fully to screw-driving efficiency.

... It's the exact pitch of the angles that eliminates driver skids.

... It's the engineered design of the 16 planes that makes it easy to apply full turning power - without reaming.

... It's the "just-right" depth of recess that enables Phillips Screw Heads to take heaviest driving pressures.

With such precise engineering, is it any wonder that Phillips Screws speed driving as much as 50% - cut costs correspondingly?

To give workers a chance to do their best, give them faster, easier-driving Phillips Recessed Head Screws. Plan Phillips Screws into your product now.

## PHILLIPS *Recessed Head* SCREWS

WOOD SCREWS • MACHINE SCREWS • SELF-TAPPING SCREWS • STOVE BOLTS

Made in all sizes, types and head styles

**25 SOURCES**

American Screw Co., Providence, R. I.  
Atlantic Screw Works, Hartford, Conn.  
The Bristol Co., Waterbury, Conn.  
Central Screw Co., Chicago, Ill.  
Chandler Products Corp., Cleveland, Ohio  
Continental Screw Co., New Bedford, Mass.  
The Corbin Screw Corp., New Britain, Conn.  
General Screw Mfg. Co., Chicago, Ill.

The H. M. Harper Co., Chicago, Ill.  
International Screw Co., Detroit, Mich.  
The Lamson & Sessions Co., Cleveland, Ohio  
Manufacturers Screw Products, Chicago, Ill.  
Milford Rivet and Machine Co., Milford, Conn.  
The National Screw & Mfg. Co., Cleveland, Ohio  
New England Screw Co., Keene, N. H.  
Parker-Kalou Corp., New York, N. Y.  
Pawtucket Screw Co., Pawtucket, R. I.

Pheoli Manufacturing Co., Chicago, Ill.  
Reading Screw Co., Norristown, Pa.  
Russell Burdall & Ward Bolt & Nut Co., Port Chester, N. Y.  
Seovill Manufacturing Co., Waterville, Conn.  
Shakeproof Inc., Chicago, Ill.  
The Southington Hardware Mfg. Co., Southington, Conn.  
The Steel Company of Canada Ltd., Hamilton, Canada  
Wolverine Bolt Co., Detroit, Mich.

**WESTINGHOUSE**

**CREATED THE**

# Ignitron

**... it revolutionized welding and is now finding new fields of usefulness**

The smooth, silent operation of resistance welding equipment is made possible by the ignitron tube—originated by Westinghouse. Ignitron tubes have broadened the field of welding to include projection welding. They have lowered costs, and increased speed and efficiency in all types of resistance welding operations. Westinghouse makes a complete line of ignitrons, the smallest of which is the WL-681/686 shown here.

But welding is only one field where ignitrons can be used. They are useful in timing operations requiring high peak currents for short durations, as X-Ray timers. They are useful in the field of motor speed control to govern the speed of medium horsepower motors. They may also be used in the field of frequency conversion and inversion.

In the WL-681/686, you have a small, light, compact tool of many applications and many adaptations of present applications. Write Lamp Division, Westinghouse Electric Corporation, Bloomfield, New Jersey.

**IGNITRON WL-681/686  
for welding service**

Maximum welder demand . . . 300 kva  
Maximum average current . . . 22.4 amp  
per tube  
Maximum RMS supply voltage 600 volts  
Length+lead . . . . 9.75+7 inches  
Diameter . . . . . 2.13 inches

© 1945, Westinghouse Electric Corporation

**Westinghouse**

PLANTS IN 25 CITIES OFFICES EVERYWHERE

*Electronic Tubes at Work*

# New! L-A-R-G-E-R Size Sheets of



Make Possible Many  
Additional Uses for this  
Superior Insulation

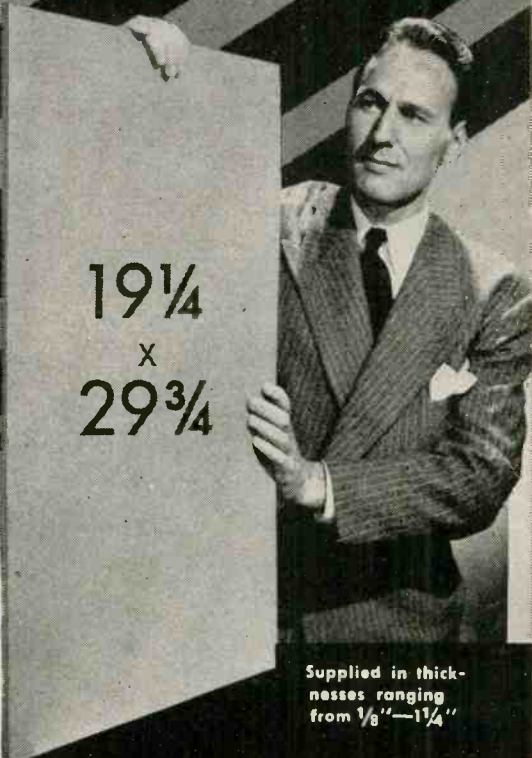

Supplied in thicknesses ranging from 1/8" — 1 1/4"

### Now You Can Use MYKROY For:

- Large Terminal Boards
- Switch Board Panels
- Large Inductance Bars and Strain Insulators up to 29 inches long
- Switch Connecting Rods
- Transformer Covers
- Large Meter Panels
- Bases for Radio Frequency and Electrical Equipment assemblies requiring large one-piece sheets

HERETOFORE the largest sheet of glass-bonded mica insulation available measured 14 1/2" x 19 1/4". By doubling the size, Electronic Mechanics, exclusive manufacturers of Mykroy, now afford Design and Production Engineers many important, new application and fabricating advantages.

Lower Cost per square inch affects savings as high as 33% depending upon work piece size, greatly reducing the cost per fabricated part. Better Cutting efficiency lowers cost still further extending the use of Mykroy to a longer list of electronic applications where formerly cost prohibited its use.

Get the full facts about this versatile dielectric now. Ask for a copy of the new MYKROY BULLETIN 102 which describes the new, larger 19 1/4" x 29 3/4" sheets.



#### MECHANICAL PROPERTIES\*

MODULUS OF RUPTURE.....	18000-21000psi
HARDNESS	
Mohs Scale 3-4 BHN. BHN 500 K9 Load. 63-74	
IMPACT STRENGTH.....	ASTM Charpy .34-.41 ft. lbs.
COMPRESSION STRENGTH.....	42000 psi
SPECIFIC GRAVITY.....	2.75-3.8
THERMAL EXPANSION.....	0.00006 per Degree Fahr.
APPEARANCE.....	Brownish Grey to Light Tan

#### ELECTRICAL PROPERTIES\*

DIELECTRIC CONSTANT.....	6.5-7
DIELECTRIC STRENGTH (1/4").....	630 Volts per Mil
POWER FACTOR.....	.001-.002 (Meets AWS L-4)

#### \*THESE VALUES COVER THE VARIOUS GRADES OF MYKROY

- GRADE 8 Best for low loss requirements.
- GRADE 38. Best for low loss combined with high mechanical strength.
- GRADE 51 Best for molding applications.

Special formulas compounded for special requirements.

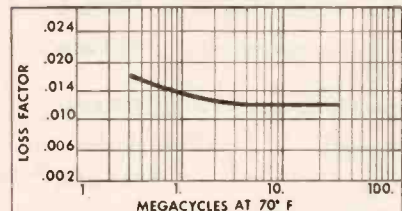

Based on Power Factor Measurements made by Boonton Radio Corp. on standard Mykroy stock.

MADE EXCLUSIVELY BY



70 CLIFTON BLVD., CLIFTON, N. J.  
CHICAGO 47, 1917 N. Springfield Ave., Tel. Albany 4310  
EXPORT OFFICE: 89 Broad Street, New York 4, New York

MYKROY IS SUPPLIED IN SHEETS AND RODS — MACHINED OR MOLDED TO SPECIFICATIONS



# BEACH PARTY

... where all the guests are gate-crashers

**F**ROM one Pacific island to another, until Tokyo itself is taken, grim American warriors will continue to visit the enemy without invitation. And with our invasion forces will go Spencer precision-made assault wire—light, highly flexible and strong—to warn of enemy infiltration . . . to speed reinforcements to a threatened sector. Proved under fire, Spencer precision steel and alloy wire is your guarantee of superior quality, unexcelled performance.



Photo U. S. Signal Corps.

★ ★ ★ ★

**SPENCER**  
*Precision*  
**WIRE**

**FINE STEEL AND ALLOY WIRE**

Spencer Wire Company  
WEST BROOKFIELD PLANT  
WEST BROOKFIELD • MASS.

# HERMASEAL

**HERMETICALLY SEALED TRANSFORMERS  
—DEPENDABLE IN SEA WARFARE!**

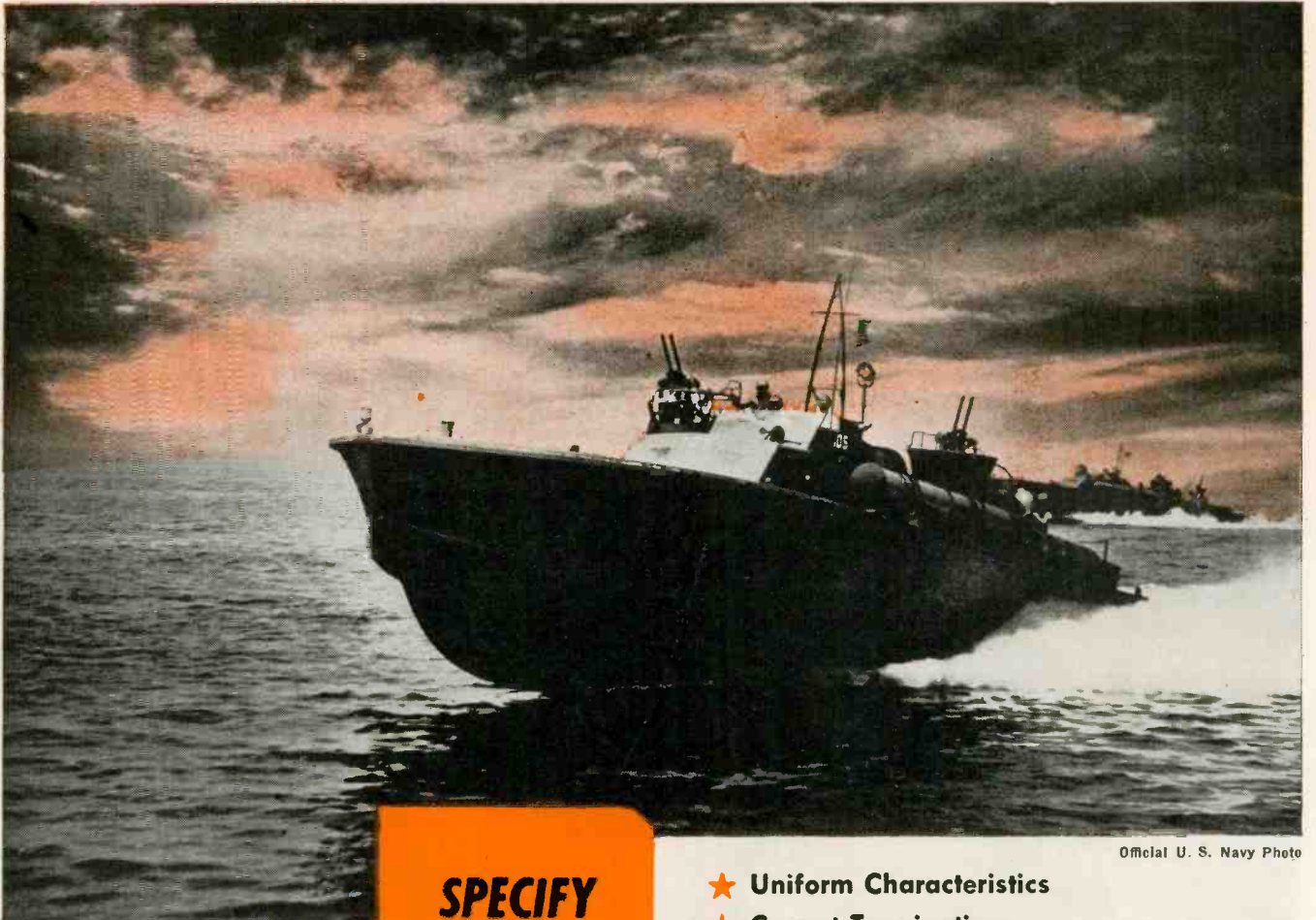

Official U. S. Navy Photo



**SPECIFY  
HERMASEAL  
AND GET  
ALL  
TEN**

- ★ Uniform Characteristics
- ★ Correct Terminations
- ★ Vacuum Immersion Test
- ★ Vacuum Impregnation—Varnish or Wax
- ★ Vacuum Filling—Oil or Wax\*
- ★ Strong Mechanically
- ★ Soldered by Induction Heating
- ★ Infra-red Pre-heating
- ★ Continuous Inspection
- ★ 42 years Experience

**HERMASEAL BY AMERTRAN**

THE AMERICAN TRANSFORMER CO., 178 Emmet St., Newark 5, N. J.

**AMERTRAN**

**HERMASEAL**

\* May now be specified instead of compound filling.

Pioneer Manufacturers of Transformers, Reactors and  
Rectifiers for Electronics and Power Transmission

**IT'S A NATURAL**

*To keep connections tight*

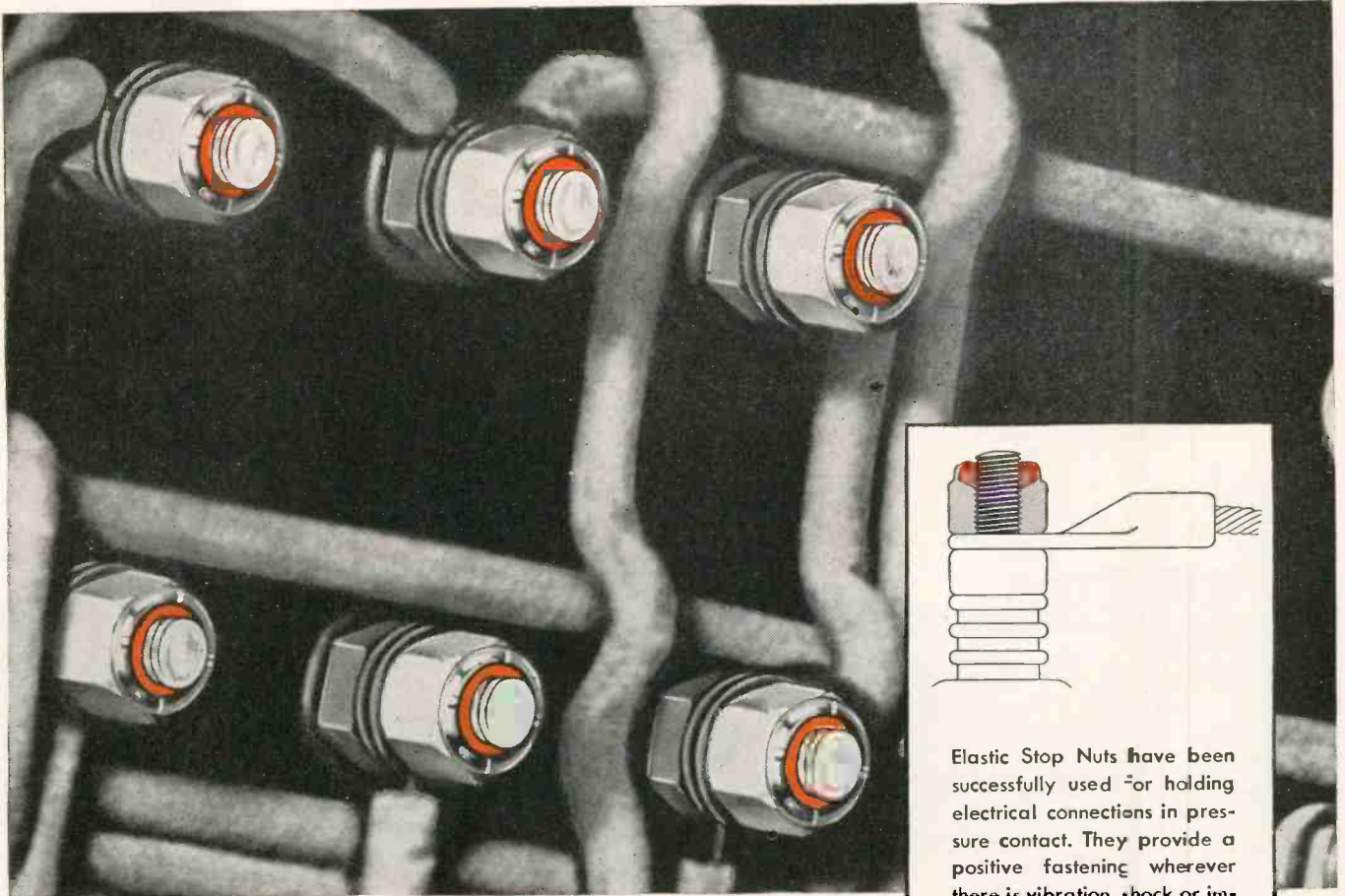

**LOOSE CONNECTIONS CAN BE ELIMINATED**

Loose connections, the bane of radio, appliance and electrical equipment manufacturers and servicemen, can be eliminated.

Vibration, shock, impact and other forces that tend to make a nut "back off" after it is wrenched into place are precisely the forces that the Elastic Stop Nut overcomes. Tens of thousands of them keep connections tight on military aircraft, tanks, trucks and other equipment today — and they will perform their important

tasks on peacetime products in the years to come.

The Elastic Stop Nut is a maximum service, minimum servicing device.

The tough, durable elastic collar firmly fixed in each nut forms itself to the bolt threads. A friction bond that really holds is the result. Once on, an Elastic Stop Nut stays on. And it can be used over and over again without losing the grip of its elastic collar.

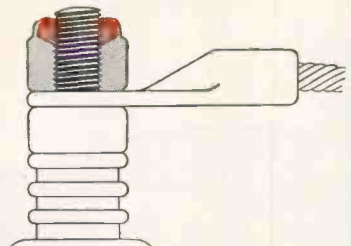

Elastic Stop Nuts have been successfully used for holding electrical connections in pressure contact. They provide a positive fastening wherever there is vibration, shock or impact. The Elastic Stop Nut prevents loose connections which arise from nut failures. Let us send an application engineer to discuss this method of reducing service charges on your products.

**LOCKS FAST TO MAKE THINGS LAST**

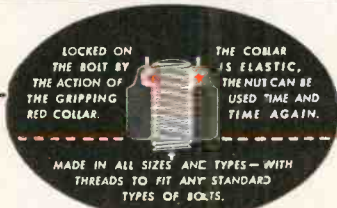

**ESNA**  
TRADE MARK

**ELASTIC STOP NUT CORPORATION OF AMERICA**

Plants at Union, New Jersey and Lincoln, Nebraska

Sales Office: 1060 Broad Street, Newark 2, New Jersey

# YOUR PRODUCTION NEED NEVER BE DELAYED

*by faulty variable resistors*

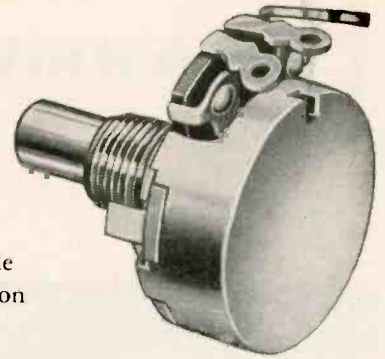

1 1/2 times  
actual size

Chicago Telephone Supply Company has achieved its world-wide leadership in variable resistors because of a well-earned reputation for prompt deliveries and flawless accuracy.

When CTS sets a delivery date it is only after making sure that, barring some major catastrophe, their production departments can keep that schedule.

And when the controls are delivered they always have the right characteristics to do the job, because CTS engineers will not start production on orders for new applications until samples have been delivered, tested and found to be exactly right.

Thus costly delays are avoided. A customer's entire production line will not be held up because the resistors have not arrived as promised, or because the characteristics do not fit the application.

If variable resistors are *your* problem, CTS service can save you considerable time, trouble and expense.

## SPACE REQUIREMENTS FOR 45 SERIES AND GC-45 SERIES



45 SERIES

GC-45 SERIES

### REPRESENTATIVES

R. W. Farris Co.  
406 W. Thirty-fourth Street  
Kansas City 2, Missouri  
Phone: Logan 7495

Frank A. Emmet Co.  
2837 West Pico Boulevard  
Los Angeles 6, California  
Phone: Rochester 9111

### BRANCH OFFICES

S. J. Hutchinson, Jr.  
401 North Broad Street  
Philadelphia 8, Pennsylvania  
Phone: Walnut 5389

### IN CANADA

C. C. Meredith & Co.  
Streetsville, Ontario

### IN ENGLAND

Chicago Telephone Supply Co.  
St. John's Woods  
103 Grove End Gardens  
London, N. W. 8, England

### IN SOUTH AMERICA

Jose Luis Pontet  
Cordoba 1472  
Buenos Aires, Argentina  
South America

Masculino 2624  
Montevideo, Uruguay  
South America

Avda. Conselheira Rodrigues  
Alves 1057  
Villa Mariana  
Sao Paulo, Brazil  
South America

VARIABLE RESISTORS  
PLUGS AND JACKS  
SWITCHES, RINGERS  
TELEPHONE GENERATORS



**CHICAGO TELEPHONE SUPPLY**  
*Company*

ELKHART • INDIANA

*Manufacturers of Quality Electro-Mechanical Components Since 1896*

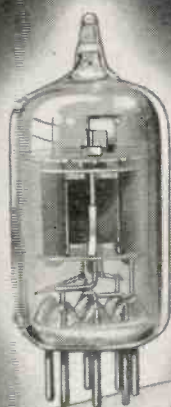

# RAYTHEON

Type 6N4  
Miniature U-H-F Triode

• An important contribution by Raytheon tube-design engineers to the efficient generation of ultra high frequency power is a miniature triode designated as type 6N4.

This cathode type tube combines the desirable features of reduced interelectrode capacitances and lead inductances with high transconductance. Thus the inevitable internal losses are minimized, making the 6N4 particularly adaptable as an amplifier, doubler, or oscillator at frequencies up to approximately 500 megacycles.

The foregoing characteristics can be used to advantage in many types of equipment which may not be publicized. However, such important functions as those performed by

the local oscillator in a u-h-f television or FM receiver are readily visualized possibilities.

In addition, Raytheon type 6N4 will be an ideal tube for civilian "walkie-talkies" and other portable radio equipment of the future. It has moderate heater power requirements and performs efficiently in the 460-470 megacycles region of the spectrum which is expected to be approved, by the Federal Communications Commission, for civilian use.

Whether or not Raytheon type 6N4 fits your particular plans, be sure to consider Raytheon High-Fidelity Tubes for your postwar products. There's a Raytheon tube that will fill your need efficiently and dependably.

## SPECIFICATIONS OF 6N4

### DIMENSIONS:

Maximum Overall Length	1 3/4 inches
Maximum Seated Height	1 1/2 inches
Maximum Diameter	3/4 inches

### RATINGS:

Heater Voltage	6.3 volts
Heater Current	0.2 amps.
Maximum Plate Voltage	180 volts
Maximum Plate Dissipation	3 watts

### DIRECT INTERELECTRODE CAPACITANCES: \*

Grid to Plate	1.1 $\mu$ f
Input	3.0 $\mu$ f
Output	1.6 $\mu$ f

### TYPICAL CLASS A CHARACTERISTICS:

Plate Voltage	180 volts
Grid Voltage	-3.5 volts
Plate Current	12 ma
Amplification Factor	32
Transconductance	6000 $\mu$ hos

\* Approximate - with close fitting shield connected to cathode.



All Four Divisions Have Been  
Awarded Army-Navy  
"E" with Stars

# RAYTHEON

MANUFACTURING COMPANY  
Radio Receiving Tube Division

NEWTON, MASSACHUSETTS • LOS ANGELES  
NEW YORK • CHICAGO • ATLANTA

DEVOTED TO RESEARCH AND THE MANUFACTURE OF TUBES AND EQUIPMENT FOR THE NEW ERA OF ELECTRONICS



# Superior

## CATHODES

SEAMLESS

and

LOCKSEAM

(PATENTED)

**SUPERIOR TUBE CO.**

NORRISTOWN, PENNSYLVANIA



"THE BIG NAME  
IN SMALL\*  
TUBING"



\*Maximum OD 3/4"



# The Little **GIANT**

## FEDERAL'S *New* LEVER KEY

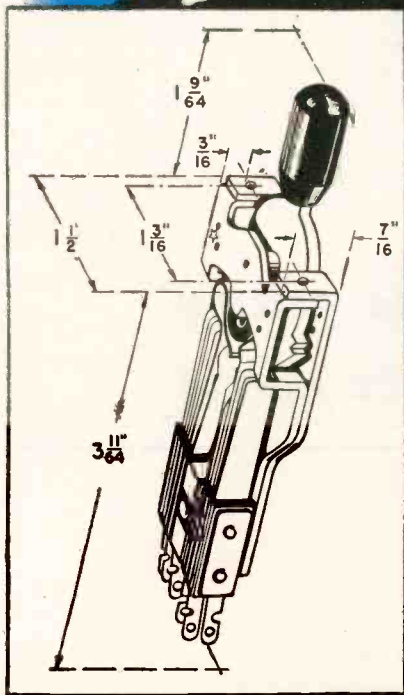
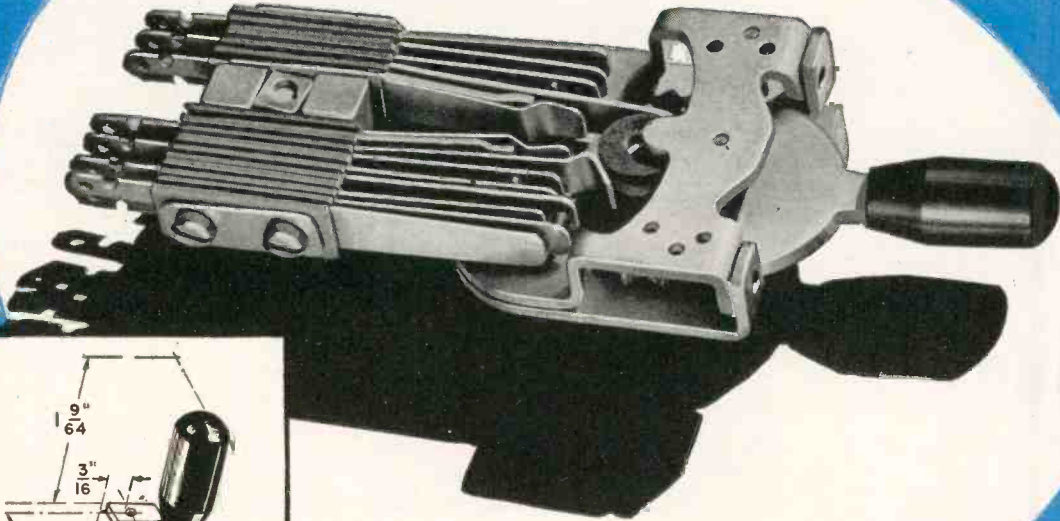

- Small Size— $\frac{5}{8}$ " horizontal mounting centers.
- Large Spring Capacity — 18 springs; over 500 possible combinations.
- Palladium Contacts . . . Nickel Silver Springs.
- High-Quality Phenol fibre Insulation.
- Universal Cam — 1 or 2 way — locking or non-locking.
- Free-Moving Roller . . . Positive Snappy Action.

Designed for finger-tip control of electronic and communications equipment where size is important, the FTR-810 Series Lever Key occupies less than half the horizontal mounting space required for older types.

And at the same time, its eighteen nickel-silver springs and low-resistance palladium cross-bar contacts permit more than five hundred possible switching combinations.

High-quality phenol fibre insulated throughout, the overall simplification in design has resulted in a more rugged, dependable lever key with a positive, snappy action that once set — stays set.

The universal cam has an unusually long bearing surface for smooth action and long life . . . for either locking or non-locking operation . . . one or two-way, simply by a change in position of the stop pins.

Here is another compact component by Federal with a wide variety of applications in control circuits, and another reason to see Federal first for electronic and communications equipment.



*Federal Telephone and Radio Corporation*



Newark 1,  
New Jersey



Wondering about tube testers?

*...Here's what Simpson has ready  
and waiting for your postwar needs*

---

**Sensational? Yes . . .**

- 1.** This new Simpson Mutual Conductance Tube Tester tests tubes with greater accuracy than any commercial tube tester ever designed.
- 2.** Provides greater flexibility for future tubes than any other tester.
- 3.** Tests tubes with voltage applied automatically over the entire operating range.
- 4.** Simplifies as never before the interpretation of tube condition from mutual conductance readings.

SIMPSON ELECTRIC COMPANY  
5200-18 Kinzie Street, Chicago 44, Ill.

**Simpson**  
INSTRUMENTS THAT STAY ACCURATE

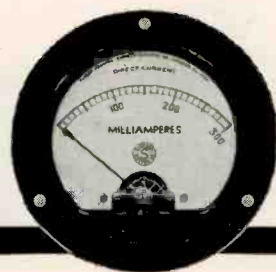



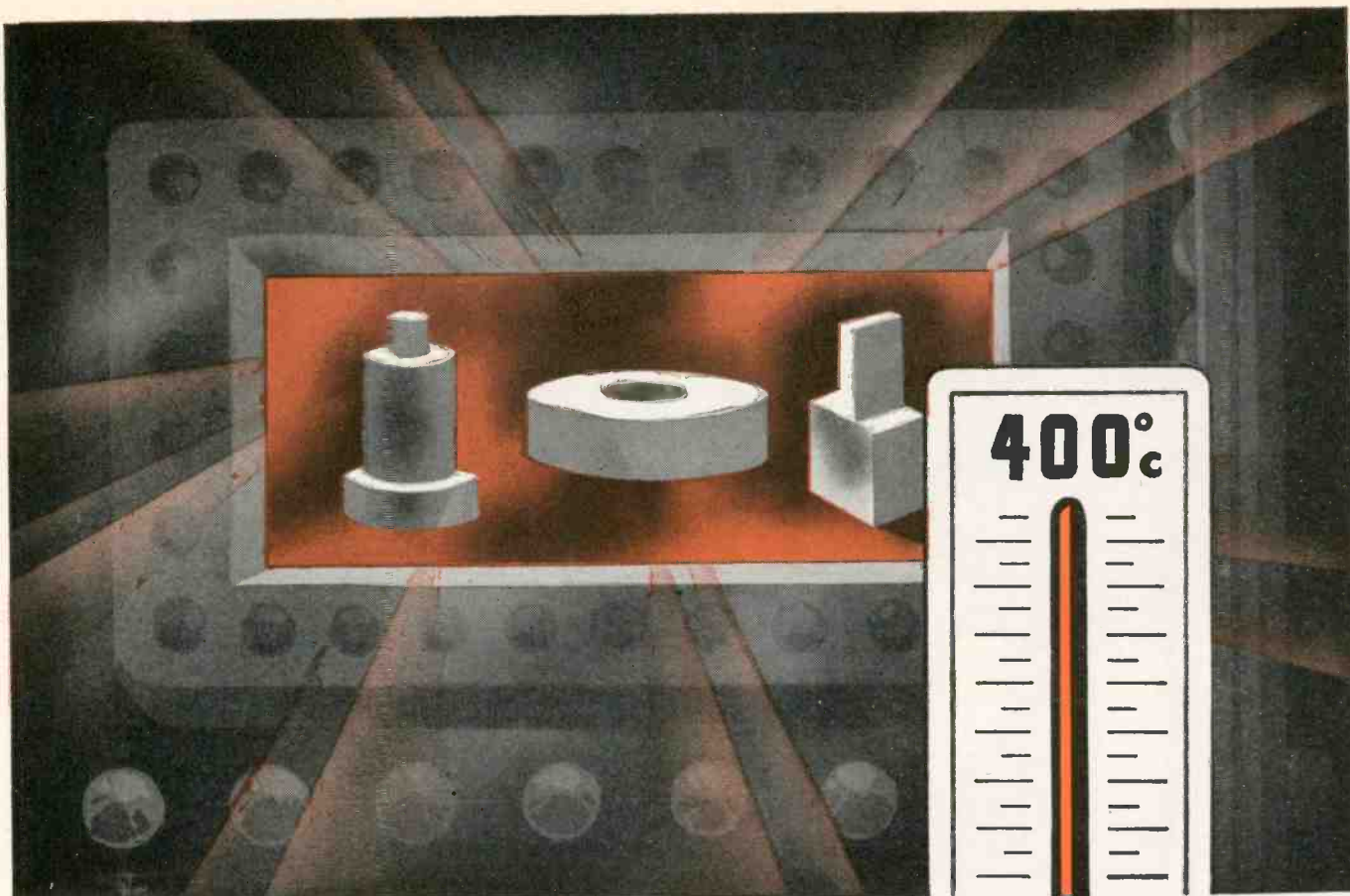

# MYCALEX 400

## WITHSTANDS HIGH TEMPERATURES

An outstanding characteristic of MYCALEX 400 is that it can withstand temperatures above 400° C. without softening or any permanent change in dimensions or properties.

Thus MYCALEX 400 has proved of great value as a low loss insulator in communications and other high frequency apparatus intended for use at elevated operating temperatures.

MYCALEX 400 is inorganic, free of carbonization... impervious to oil and water... not subject to cold flow. It meets all Army and Navy specifications as Grade L-4 material (JAN-I-10). It combines low loss factor with machinability to close tolerances. In sheets and rods. Fabricated to specifications.



### OTHER MYCALEX CORPORATION PRODUCTS

#### MYCALEX K

A series of ceramic capacitor dielectrics, with dielectric constant selectable from 8 to 19. Low power factor, high dielectric strength. Meets Army and Navy requirements as Class H material (JAN-I-12). To specifications.

#### MOLDED MYCALEX

Low loss, high temperature injection molded insulation. Molded in union with metals in irregular shapes. High production rates result in economical prices.

MYCALEX K and MOLDED MYCALEX will also withstand 400° C.

# MYCALEX CORPORATION OF AMERICA

"Owners of 'MYCALEX' Patents"

Plant and General Offices, CLIFTON, N. J.

Executive Offices, 30 ROCKEFELLER PLAZA, NEW YORK 20, N. Y.

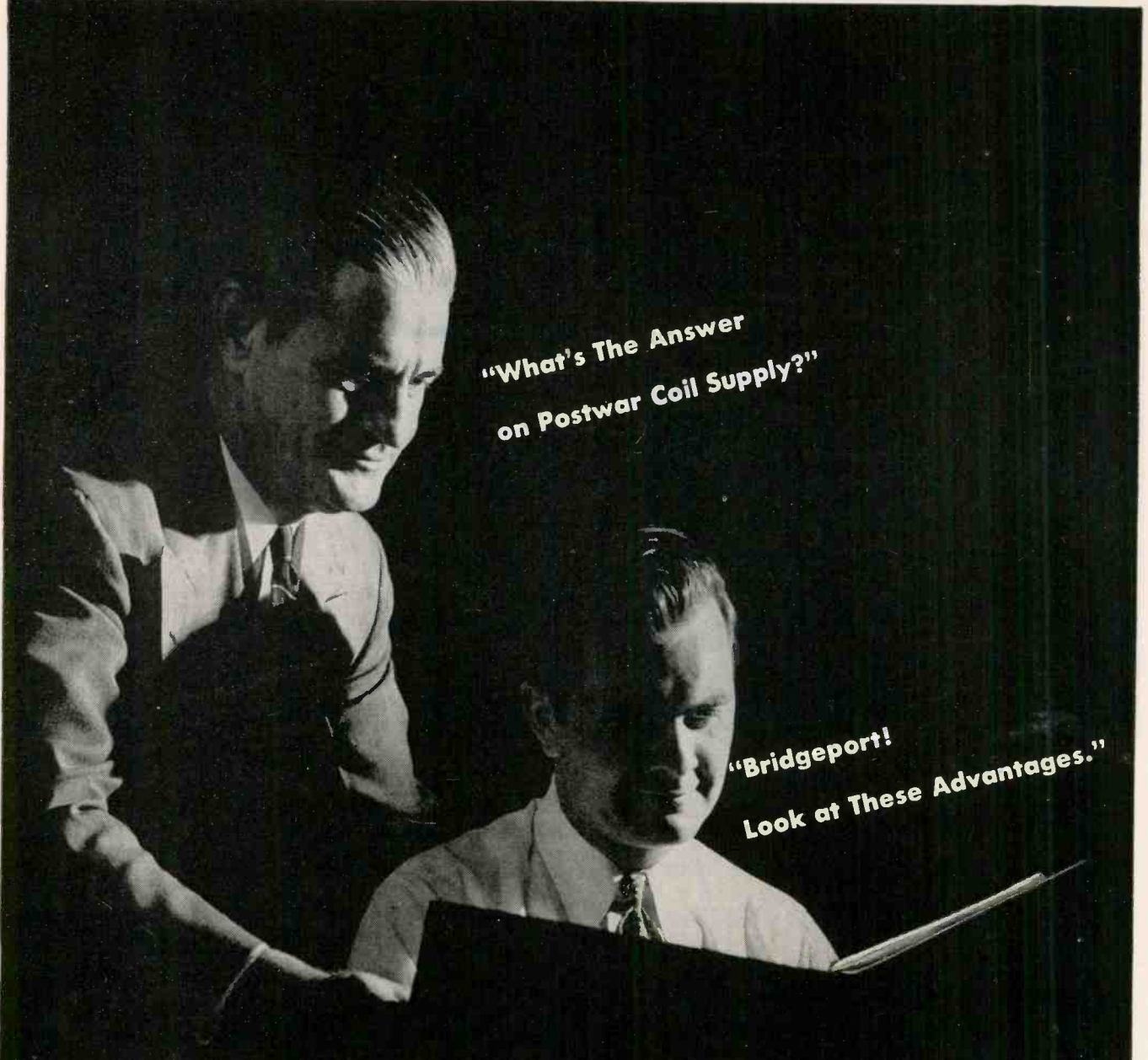

**"What's The Answer  
on Postwar Coil Supply?"**

**"Bridgeport!  
Look at These Advantages."**

**Yes, Here's Why Bridgeport's the Answer to Postwar Coil Supply Problems**

Bridgeport has the personnel and facilities. Right now, they're turning out highly important search coils and variometers for the armed forces. After their war job is done, the same skilled technicians will be able to give you the benefits of this experience in high production of quality radionic equipment.

And look at Bridgeport's central location! Because it is located near the population center of America, Bridgeport can give you fast, trunk line service to any part of the country. Place your order with Bridgeport NOW to insure early postwar delivery.



**BRIDGEPORT**

**MANUFACTURING COMPANY**  
Bridgeport, Illinois

R. F. Coils • R. F. Chokes • I. F. Transformers  
Transmitting Coils • Transmitting Chokes

stop that **noise!**

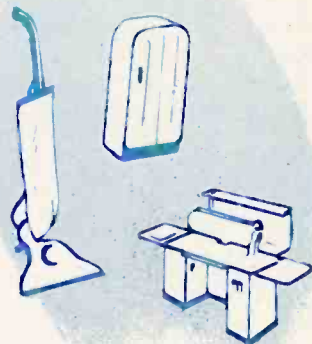

**Capacitor  
Engineering  
That Licked  
Radio Noise**

Vehicular radio equipment being manufactured now for military use is free from radio noise . . . thanks to the engineering that produced small compact capacitors and filters for generators, inverters, motors and other equipment.

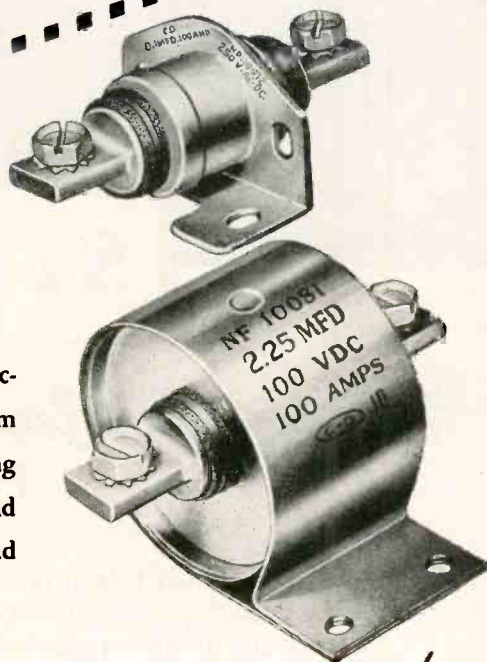

**The NF series of C-D feed-thru capacitors is specially designed and built for this service . . . to reduce radio noise.**

Small and compact, they can be mounted in any position and will operate over a temperature range of plus 85° to minus 55° C. One power line can be fed through the unit, reducing internal inductance and resistance and increasing filtering efficiency. Rated up to 250 V. AC-DC, 100 amps., in sturdy, round metal containers.

Other types of filters and feed thru capacitors are available in a range of sizes and ratings. Write for information. Cornell-Dubilier Electric Corporation, South Plainfield, N. J. Other plants at New Bedford, Brookline, Worcester, Mass., and Providence, R. I.

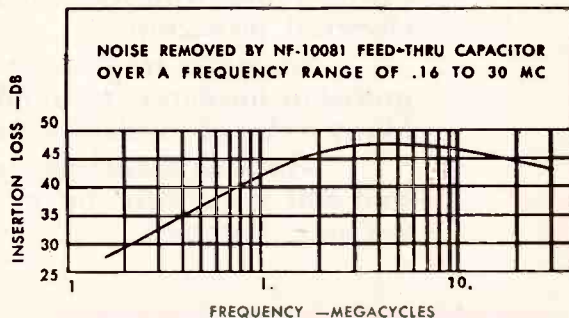

**CORNELL-DUBILIER  
CAPACITORS**

1910



1945

MICA ★ DYKANOL ★ PAPER ★ ELECTROLYTICS



# STUPAKOFF

## Engineered Ceramic Insulators FOR ELECTRICAL APPLIANCES

**S**TUPAKOFF Insulators—engineered to meet the rigid requirements of mass production methods—offer profitable advantages to manufacturers in the appliance industry.

They are mechanically strong to withstand manufacturing operations—dimensionally accurate for quick assembly—always uniform, keeping production lines flowing smoothly. Made of ceramic—inorganic, dense, non-hygroscopic materials—they provide maximum electrical protection.

Stupakoff facilities are geared to provide an unending flow of precision insulators to builders of electrical and electronic products. Many styles of insulators are stocked for immediate shipment.

Write us about your requirements. A competent and experienced staff will work with you in the development of engineered ceramics for your products.

BUY MORE WAR BONDS



STUPAKOFF CERAMIC AND MANUFACTURING CO., LATROBE, PA.

*Ceramics for the World of Electronics*





## FITTING THE KEY TO THE LOCK

Deriving the most from frequency control and selection circuits employing quartz crystals calls for a recognition of the fact that a crystal is also a circuit element and, as such, is influenced by and in turn influences other circuit characteristics. It is a case of fitting the key to the lock.

The interdependence of crystal and tube in any circuit application poses design problems that are common to the crystal engineer, the tube engineer and the circuit engineer. Solutions are more readily arrived at by a pooling of specialized knowledge.

As manufacturers of crystals and tubes, the North American Philips Company has an intimate knowledge of both. Our engineers are therefore particularly well equipped to cooperate with circuit design engineers in any application problems involving the use of crystals. As an example, the circuit shown at right was suggested by our crystal applications laboratory as one means of employing crystal control in a push-button tuned receiver.

Although the armed forces have first call on our crystal production facilities, we invite inquiries from manufacturers interested in the utilization of low-cost precision quartz crystals for industrial and commercial applications. A booklet "How Quartz Crystals are Manufactured" is available on request.

Crystal-controlled oscillator circuit for push-button tuned receivers, using the series resonance of the crystal as the control factor. No adjustment is required over a frequency range as great as 2 to 1.

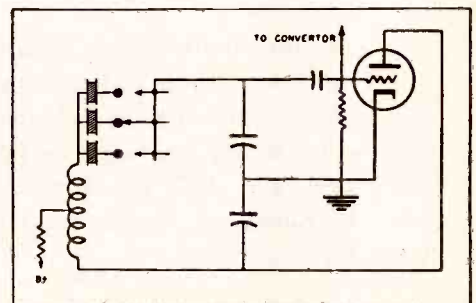

**Norelco** Electronic Products by  
INC. U.S. PAT. OFF.

OTHER PRODUCTS: Amplifier, Transmitting, Rectifier and Cathode Ray Tubes; Searchray (Industrial X-ray) Apparatus; X-ray Diffraction Apparatus; Medical X-ray Equipment, Tubes and Accessories; Tungsten and Molybdenum products; Fine Wire; Diamond Dies. We invite you to visit our office and showroom when in New York City.

**NORTH AMERICAN PHILIPS COMPANY, INC.**

Dept. B-7, 100 East 42nd Street, New York 17, N. Y.  
 Factories in Dobbs Ferry, N. Y.; Mount Vernon, N. Y. (Metalix Div.); Lewiston, Maine (Elmet Div.)

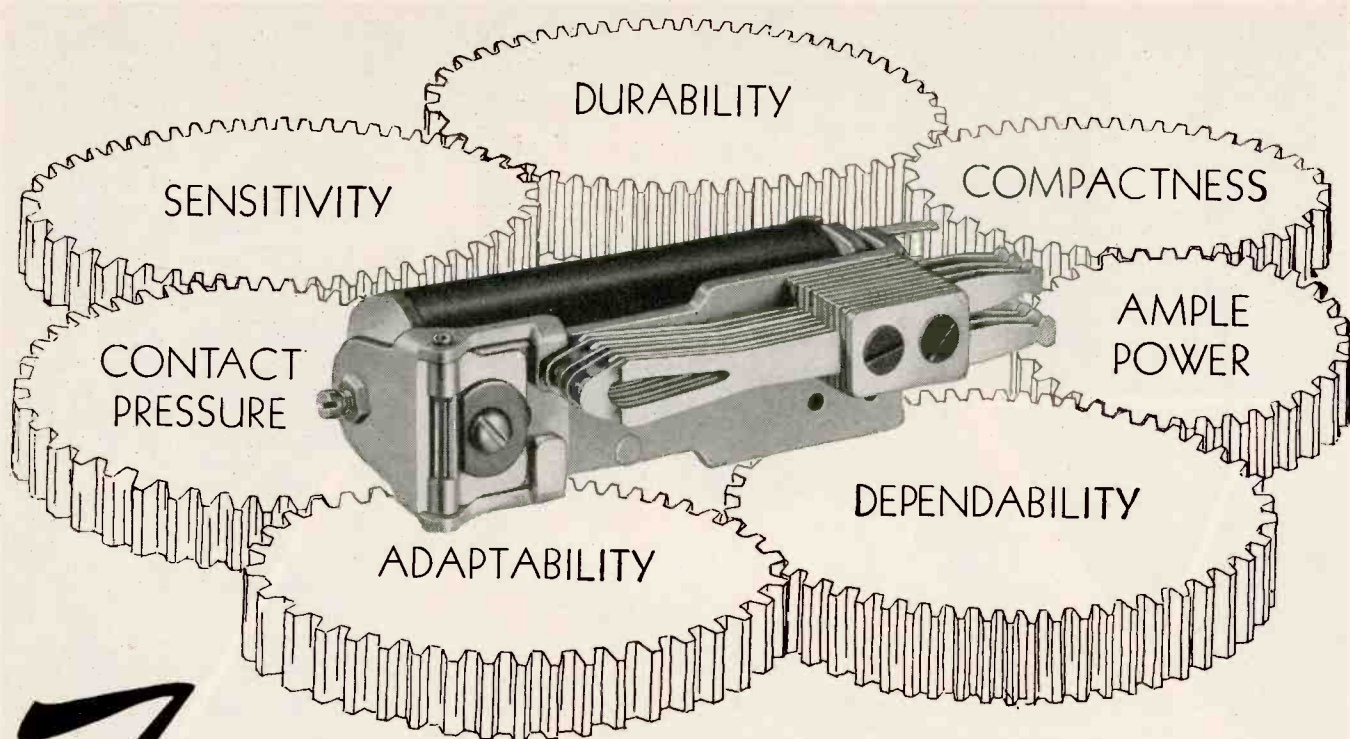

# 7 vital qualities **GEARED TOGETHER** **IN THE NEW AUTOMATIC ELECTRIC CLASS "B" RELAY**

• Check over one by one the qualities you want most in any relay. Here, in this new relay, you will find them all—combined to give outstanding performance in any electrical control application.

Sensitive enough to operate on minute current, the Class "B" has also the high contact pressure needed for perfect closure—

Compact enough for multiple mounting in small space, yet with ample power for operating up to 28 contact springs—

With inbuilt quality needed for long service under tough conditions, and the dependability provided by dual circuit paths through independent twin contacts—

It will pay you to get the full story on this remarkable new relay. It is one of the forty basic types described in Automatic Electric's catalog 4071-D. Write today for your copy.

**ONLY THE CLASS "B" RELAY HAS ALL THESE DESIGN FEATURES:**

*Twin Contacts*—providing dual circuit paths for maximum reliability.

*Efficient Magnetic Circuit*—for sensitivity and high contact pressure.

*Unique Armature Bearing*—for long wear under severe service conditions.

*Compact Design*—for important savings in space and weight.

*Versatility*—Available for coil voltages to 300 volts d-c and 230 volts a-c, and with contact capacities up to 28 springs; also with magnetic shielding cover if desired.

*Relays*  
 AND OTHER CONTROL DEVICES  
*by* **AUTOMATIC ELECTRIC**



**AUTOMATIC ELECTRIC SALES CORPORATION**  
 1033 West Van Buren Street • Chicago 7, Illinois

In Canada: Automatic Electric (Canada) Limited, Toronto

**PARTS AND ASSEMBLIES FOR EVERY ELECTRICAL CONTROL NEED**

350 WATT  
POLICE HEADQUARTERS  
TRANSMITTER



CUSTOM BUILT  
POWER TUBE LIFE-TEST RACK

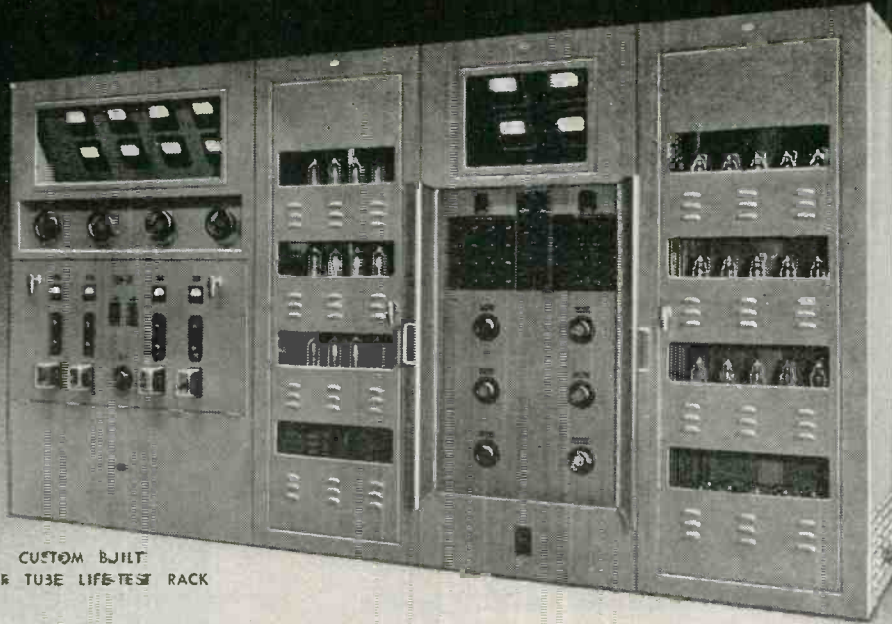

100 WATT  
MARINE RADIO  
TELEPHONE TRANSMITTER  
AND RECEIVER

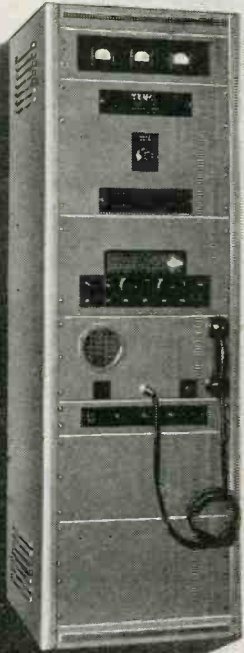

# Orders Filled Within **30 to 60 DAYS**

TEMCO can assure delivery of 250 Watt to 10 KW Transmitters for Broadcast and other services within 30 to 60 days after hostilities cease and restrictions are lifted.

Although our skills, at present, are devoted exclusively to producing Radar and special Electronic Equipment for the armed services involving mechanical and electrical complexities of the highest standards, TEMCO engineering versatility and production flexibility are geared for a quick changeover to fill post-war orders rapidly.

Ours is a long standing reputation for designing and building high quality communication and electronic devices. By placing your order now with TEMCO you will be assured of prompt delivery of perfected Transmitting equipment. TEMCO advancements in design, materials and construction are ready to serve you as an aid in the success of your post-war plans.

Consult with us at your earliest convenience regarding your requirements.



COAST GUARD  
ANTENNA TUNING  
UNIT

STUDIO S-ECH  
INPUT ASSEMBLY

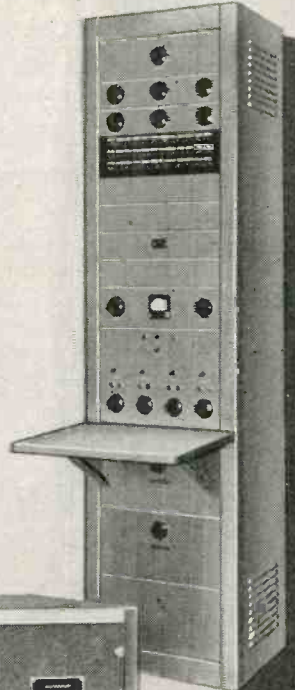

HETERODYNE  
FREQUENCY  
METER

# TEMCO

**RADIO COMMUNICATION EQUIPMENT**

**TRANSMITTER EQUIPMENT MFG. CO., INC.**

345 Hudson Street, New York 14, N. Y.

# RAYTHEON VOLTAGE STABILIZERS

Keep Varying Input Voltages Uniform

at  $\pm \frac{1}{2}\%$  of 1%

Built into new equipment or incorporated into equipment already in use, Raytheon Voltage Stabilizers improve the operation of electrical equipment by stabilizing varying input voltages to  $\pm \frac{1}{2}\%$  of 1% within 2 cycles.

Because they have no moving parts . . . nothing that wears out, they require no adjustments or maintenance. Simply hook them up and Raytheon Voltage Stabilizers will give years of trouble-free service.

Many models and ratings are available for practically every application requiring uniform voltage. All stabilize voltages at any load within ratings to  $\pm \frac{1}{2}\%$ .

Standard Raytheon Voltage Stabilizers may be had for controlling A. C. input variation of 95 to 130 volts or 190 to 260 volts. Write for bulletin DL48-537. It gives dimensions, operating characteristics and other important data.

## HARMONIC CONTENT

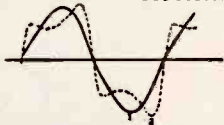

The high magnetic density in one of the transformers introduces harmonics in the output voltage wave. The actual harmonic content is usually unimportant except when instruments are being calibrated.

The output wave form is illustrated in the accompanying figure and table.

### ANALYSIS OF OUTPUT VOLTAGE

Curve No.	Input Volts	Percentage Harmonic			
		1st	3rd	5th	7th
I	95	99.4	7.1	2.2	Trace
II	131	96.8	24.0	7.0	3.6

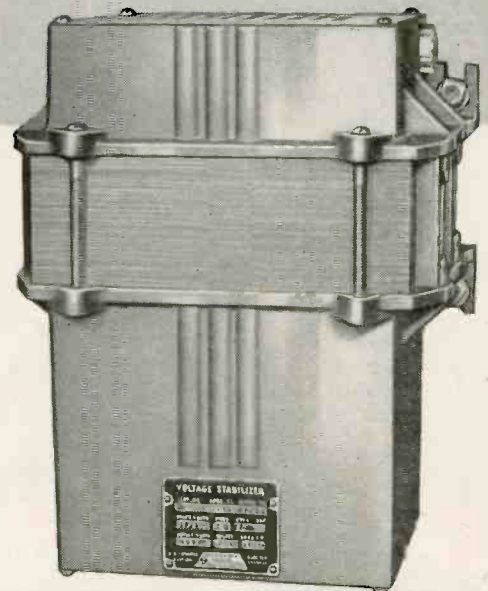

ENDBELL MODEL

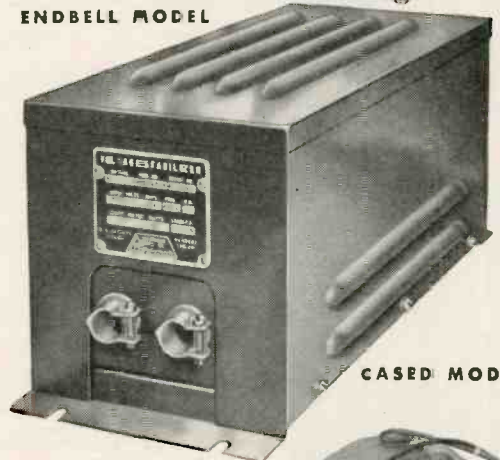

CASED MODEL

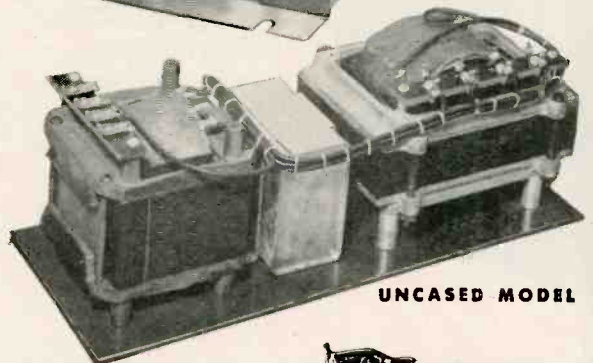

UNCASED MODEL

Tune in the Raytheon radio program: "MEET YOUR NAVY," every Saturday night on the Blue Network. Consult your local newspaper  for time and station



**RAYTHEON**  
MANUFACTURING COMPANY

Electrical Equipment Division

190 WILLOW STREET, WALTHAM, MASS.

Devoted to research and manufacture of complete electronic equipment; receiving, transmitting and hearing aid tubes; transformers; and voltage stabilizers.

The coveted Army-Navy "E," for Excellence in the manufacture of war equipment and tubes, flies over all four Raytheon Plants where over 16,000 men and women are producing for VICTORY.



# Double Check

**MAKE SURE THE MOTOR APPLICATION IS**

**RIGHT FROM THE START**

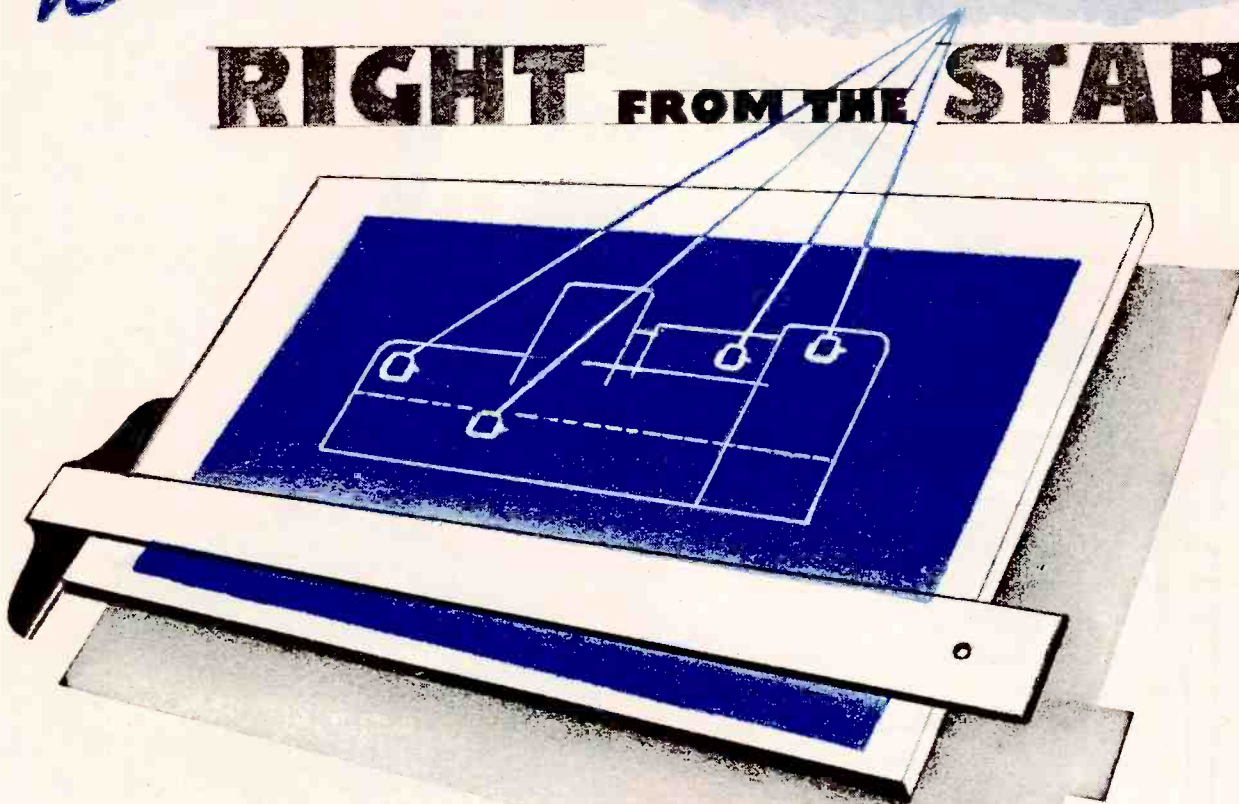

## ASK A WESTINGHOUSE APPLICATION ENGINEER TO HELP

Check it three times, if necessary, to make certain your product design makes use of standard motor types whenever possible. Minor changes in the appliance may permit utilizing standardized designs instead of more costly specially-engineered units.

Such designs hold many advantages for both you and your customers. Costs are reduced and deliveries speeded. Required inventories are lowered. Servicing is simplified.

Let the broad experience of Westinghouse Engineers in applying fractional horsepower motors help you with your appliances while they are still on the drawing board. The time is now. Ask your Westinghouse office or write Westinghouse Electric Corporation, P. O. Box 868, Pittsburgh 30, Pa.

J-03216

# Westinghouse

SMALL MOTOR DIVISION

**MOTOR EXCHANGE PLAN PROVIDES  
REPLACEMENT SERVICE IN  
24 HOURS OR LESS**

**ANYWHERE IN THE UNITED STATES**

Westinghouse Motor Exchange points in all principal cities can service most Westinghouse small motors of standard sizes in 24 hours, or less, anywhere in the United States. This service gives the appliance user an efficient, factory-rebuilt replacement motor in exchange for his old motor at a low, flat cost. Your nearest Westinghouse office will give you full details. Ask for bulletin B-3336.



**NOW WE CAN SERVE YOU  
... FOR DELIVERY NOW**



**We Solicit  
Your Inquiries . . .  
for Engineering or Production**

**SUPER ELECTRIC  
PRODUCTS CORP.**

**1057 Summit Avenue  
Jersey City, N. J.**

# STEADY JOBS

## *and* EQUIPMENT BUYING

---

**S**USTAINED employment is not an attainable goal unless we can moderate the erratic fluctuations which have characterized the markets for producers' equipment in past periods.

In the 35th editorial of this series, "Sustained Construction Activity", it was pointed out that there is no specific that can cure our economy of its "boom-or-bust" proclivities. Rejecting the notion that the construction industry could be so managed as to stabilize business as a whole, that editorial stressed the important contribution it could make to that end, and suggested several practical expedients through which construction activity might be regularized.

Producers' equipment represents an area of production quite as broad and diverse as construction, though smaller in aggregate value. The classification embraces all types of durable equipment bought and used for profit—locomotives, motor trucks, electric generators, conveyors, machine tools, farm implements, and so on down to surgical instruments and dentists' drills.

Although the output of such equipment averages over a long period only 5 or 6 per cent of the nation's total output, it resembles construction in its extraordinary ups and downs. While its component items differ widely in the amplitude and violence of their fluctuations, the class as a whole is one of the most unstable sectors of the economy, making therefore a quite disproportionate contribution to the cyclical swings of total production and employment. From 1929 to 1932, for example, the decline in the output of producers' equipment (at constant prices) was 65-70 per cent, in contrast to a decline of 25-30 per cent in the national output exclusive of such equipment and construction.

A more recent example of the volatility of demand in this field may be found in the movement of a monthly index of orders for industrial equipment, which rose from 92 in the spring of 1936 to 160 in the spring of 1937, falling thence to 65 in the summer of 1938 and rising again to 142 in the fall of 1939. Such fantastic oscillations present an obvious and inescapable challenge to all concerned with economic stabilization.

Not only are these fluctuations bad for the economy; they represent demonstrably bad buying policy on the part of the purchasers of equipment. Peaks in demand come characteristically just before a business depression (1919, 1929, and 1937, for example)

when machinery costs the most to buy and install and when it has the lowest expectancy of continuous use. At exactly the wrong moment everyone wants to buy. In the depression itself, on the other hand, with costs down, and with nowhere for the economy to go but up, equipment is a drug on the market. No one wants it when it is cheap and has the greatest prospect for steady employment. Here is a behavior pattern so profoundly irrational there must be hope for its correction.

There is an inveterate tendency for business management to forecast the future simply by projecting the trends of immediate past. Although it is axiomatic that the chance for an extended period of further prosperity is inversely related to the duration of the prosperity already experienced, this truism is generally ignored. The longer the boom has run, the more certain is business management that it will continue indefinitely. Convinced at last by "actual experience" that prosperity is here to stay, executives give the green light to commitments for expansion and modernization previously deferred in a skeptical attitude of "wait and see". The result, so often repeated in our economic history, is an explosive burst of demand for equipment coincident with, and contributing to, the final spasm of a boom. Witness the phenomenal rise in industrial equipment orders during 1928 and the spring of 1929.

The same prophetic illusion works in reverse during a depression. Recent experience is projected into the future. Although the mathematical probability of an imminent and prolonged period of prosperity increases directly with the duration of a depression, it finds little reflection in business decisions. Timidity and caution are the order of the day.

Compounding the errors caused by faulty perspective, are a number of influences which make it extremely difficult for individual enterprises to follow a policy geared to sensible long-term considerations. In a boom, particularly in its climactic phase, most producers find their order books crowded beyond the potential of their current capacities and are faced with the alternatives of expanding or losing trade to competitors. In depression the situation is reversed, and producers with unused facilities find it difficult to justify increases in their capital charges.

An even more controlling factor in many cases is the availability of funds. This is especially important

for small concerns. Typically such firms enjoy but limited credit, and with no ready access to the securities markets, their capital expenditures depend primarily on earnings. When they are making money, they can afford to buy equipment; when they are losing, they largely disappear from the equipment market. Even great enterprises, though less dependent on earnings as a source of capital financing, are profoundly influenced by the volume of internal funds available for the purpose, a volume as a rule far greater in prosperity than in depression. Moreover, it is usually easier in good times to obtain outside funds through the sale of stock or by borrowing, since in bad times bankers, underwriters, and investors are susceptible to the same timidity and caution that afflict business management generally.

We are dealing here with a combination of psychological, physical, and financial forces which conspire to aggravate the instability of demand for capital equipment. What can be done to reduce this instability and thus to bring equipment purchasing into a more sensible and constructive pattern?

There is no panacea, no royal road to the solution. The problem has been with us since the beginning of the industrial economy. It is complex and difficult. It is not, however, wholly intractable. We may reasonably hope that industry will, through intelligent effort, make substantial progress toward a satisfactory solution. The industrial equipment field is one in which government, except for war periods, has exerted little direct control. The best insurance against the institution of government measures is to so conduct activities in the equipment field that no justification for government interposition can be made.

☆ ☆ ☆

1. The first and most important step is for industry itself to reconsider its heretofore haphazard and opportunistic policy in the purchase of equipment, substituting so far as possible a regularized, long-range programming of expenditure that will resist both the excited long-buying of booms and the equally disturbing underbuying of depressions. Such long-range programming is particularly appropriate and advantageous for large enterprises in established industries such as railroads, electric power, steel, automobiles, and the like, but it makes sense much more generally.

Once executives come to realize that a reasonably stable equipment program contributes not only to the welfare of the economy but also to the lowering of their long-run equipment costs, the opportunity to combine a public service with private advantage should induce them to recast their policies accordingly.

There is an even more compelling reason for purchasers of industrial equipment to do everything possible to regularize their demands. Some concerns unquestionably will find themselves in a postwar position where speedy delivery of needed equipment, even though it involves the payment of premium prices, will seem to be justified. But there is no system of accounting that can show it to be a profitable transaction to promote an equipment industry boom that runs a brief

course only to collapse when the backlog of deferred maintenance and development has been satisfied. That, historically, has been the trigger which trips the door to the depression phase of the business cycle. No immediate advantage can compensate for the contagious paralysis that infects all business enterprise when major layoffs occur in any major segment. No precautionary measures, self-imposed by business, can be regarded as unduly severe if they can prevent this devastating blight.

2. Financial agencies can and should play a responsible role in regularizing equipment demand. Funds for the purchase of producers' equipment should be offered boldly and at low interest during depression periods, and should progressively tighten as a boom market bids up the price of purchase and installation. Banks and financial houses have excellent facilities for gathering and interpreting market and general economic information. It is good business for them, and for the national economy, to exercise their accepted discretions in a manner that will help to promote economic stability.

3. There now is almost universal recognition of the need for a thorough-going revision of our corporate tax structure to the end that effective incentives may be offered for private capital investment. The possibility of including provisions which would offer special tax concessions to equipment investments made in depression periods is worthy of intensive exploration.

☆ ☆ ☆

The fundamental problem here is educational. If all business enterprises in a position to do so were to regularize their equipment expenditures, it would have a tremendously beneficial effect. True, it would accomplish no miracles. For many concerns it is not feasible to schedule equipment buying over a long period. Even those who do schedule it are likely in practice to attain only a relative stability. It must be acknowledged, moreover, that few programs could withstand indefinitely a very deep and prolonged depression such as we had in the thirties. Nevertheless the adoption of stabilization policies where feasible would make a signal contribution both to the restraint of booms and to the mitigation of depressions. Here is something industry can do for itself.

It is easy to disparage such remedies for economic instability as are here proposed on the ground that they are partial only. However, joined with others also partial, they can achieve in combination a solid progress toward the goal of sustained high level employment—progress that is unattainable through economic cure-alls. The road suggested is a slow road, and difficult, but it leads upward.



President, McGraw-Hill Publishing Co., Inc.

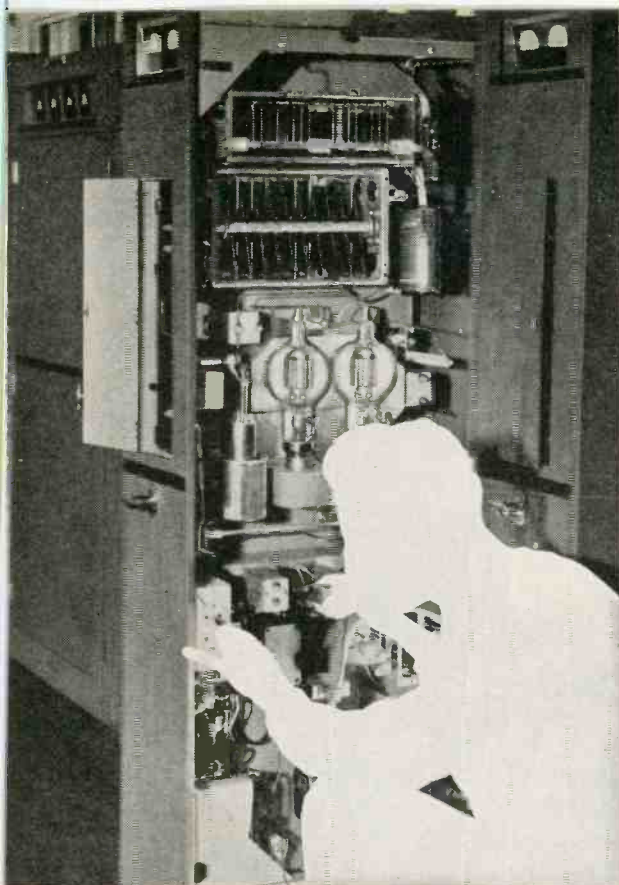

*AACS Domestic Station  
showing a pair of  
Eimac 450-T tubes*



*AACS Ground Station  
China-Burma-India Theatre*

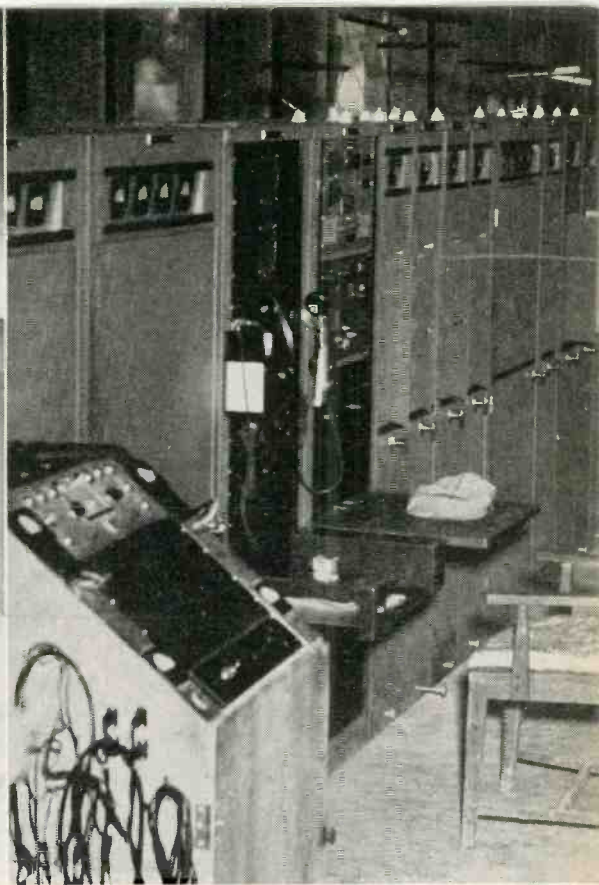

# AACS\* BLAZES THE TRAIL FOR SAFE FUTURE WORLD AIR TRANSPORTATION

World-wide aviation communications are an established fact today. Almost overnight a great radio network has been created. The actual physical difficulties involved were great enough, to say nothing of the variety of extreme operating conditions encountered and overcome. Needless to say, the equipment employed must be dependable, both from a standpoint of construction and performance capability.

The establishment of radio ground stations on every continent and in fifty-two different countries...overcoming the widest extremes in operating and climatic conditions (from 40 degrees below zero to 140 degrees above)...stations in jungles...in deserts...in mountains and towns...and to have these stations constantly operating at near peak levels is a tribute to the equipment employed. On this page are shown three AACS Stations located at widely separated spots on the globe.

**FOLLOW THE LEADERS TO**



Get your copy of *Electronic Telesis*... the sixty-four page booklet which gives the fundamentals of electronics. This little booklet will help electronic engineers explain the subject to laymen. It's yours for the asking... no cost or obligation. Available in English and Spanish languages.

EITEL-McCULLOUGH, INC., 1030 San Mateo Ave., San Bruno, Calif.  
Plants located at: San Bruno, California and Salt Lake City, Utah  
Export Agents: Frazar & Hansen  
301 Clay Street, San Francisco 11, California, U. S. A.

\*A. A. C. S. (Army Airways Communications System)

*AACS Station on an island in South Pacific*



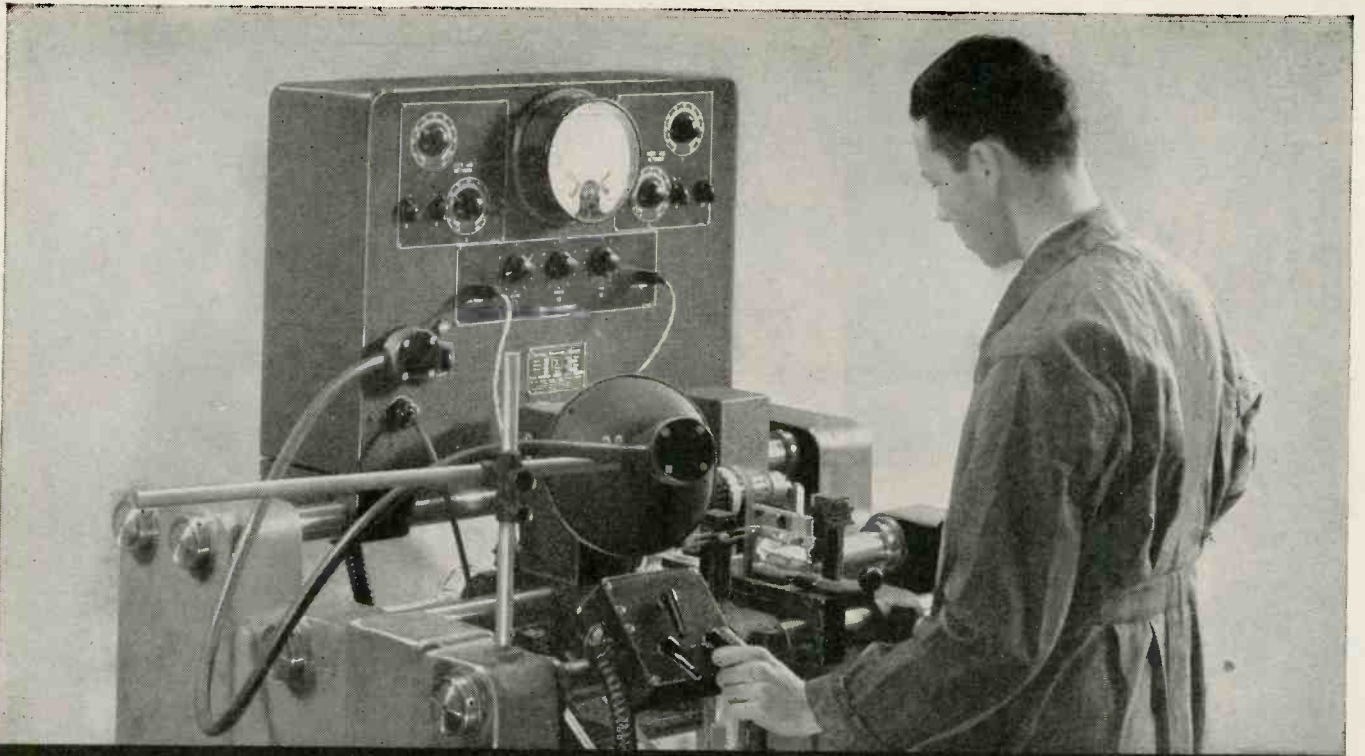

# PRECISION SWITCHES

## *Speed Precision Balancing*

With this Mallory-equipped Gisholt Dynetric Balancing Machine, an operator can quickly locate and measure unbalanced forces in high speed rotating parts. By means of a stroboglow lamp and electronic circuits, precise measurements—that once took hours—are now obtained in a few seconds.

Ten Mallory Circuit Selector Switches assure swift, smooth control of all circuits in this balancing machine. Each Mallory switch is a *standard* part, yet each includes *special precision* features: low-resistance, self-cleaning silver-to-silver contacts; "hill-and-valley" index for smooth, positive switching action; heavy moisture-proof insulation; sturdy one-piece terminals.

In this Dynetric Balancer, Mallory Type M Potentiometers are used in the amplifier circuits to adjust grid bias. This potentiometer is not a special item—it's another *standard* part from the diversified line of Mallory precision products—switches, resistors, volume controls, condensers, jacks, plugs and other parts.

While the new circuits you're planning are still on the "bread-board", you can probably save time and money by specifying *standard* Mallory parts, built for *precision*. It's easy to draw up specifications when you use the latest Mallory catalog. Ask your nearest Mallory Distributor for a free copy.

Or write us today.



P. R. MALLORY & CO., Inc., INDIANAPOLIS 6, INDIANA



P. R. MALLORY & CO. Inc

# MALLORY



## Industrial and Electronic Switches



# CROSS TALK

► **FM's FUTURE** . . . FCC's decision to postpone final allocation of f-m channels until fall, as reported elsewhere in this issue, has a background of controversy which deserves most careful analysis. The debate started, last year, as a technical argument concerning v-h-f propagation, a field where differences of opinion are the rule—not the exception. Since the economic aspects of fm were involved, the argument quickly broadened to include questions of public and private investment. The economic arguments were two: (1) any change in the f-m band would make obsolete equipment in public hands and (2) any change would depreciate, if not wholly wipe out, the broadcasters' investment in existing f-m stations.

First, the public investment: if a set owner wishes to retain his pre-war f-m set to receive fm on any new band, he has to install a simple converter. Moreover, such a converter is required, *in any event*, to cover extension of the existing f-m band to provide more channels for a nationwide, competitive system. The necessity for such extension has never been in question at any stage of the discussion.

Second, the broadcasters' investment; at the beginning of the controversy, the broadcaster may well have believed that by insisting on retention of the present band he could preserve his investment intact. But here, again, technical judgment has indicated otherwise. It is now agreed, by all parties to the argument, that high-power f-m broadcasting stations should move above 50 Mc to avoid  $F_2$ -layer interference. Since all present allocations are below 50 Mc, this means that all high-power stations (50-kw and 10-kw power) must move in any event. These stations represent a very large part of the broadcasters' present investment.

In short, as far as investment is concerned, public or private, additional costs must be borne to allow fm to expand.

The remaining items of controversy are technical: what is the effect of frequency, over the range from 44 to 108 Mc, on (1) the extent of the several forms of interference and (2) the coverage afforded? Here,

also, there is much more general agreement than appeared earlier in the year. As noted, there is agreement that  $F_2$  reflections may give trouble, during the sunspot maximum, at the lower frequencies, between high power stations. The argument turns on a matter of degree: where in the region between 44 and 108 Mc will the interference cease to be troublesome? Major Armstrong believes that the trouble will be negligible above 60 Mc. He favors the lowest of the three FCC alternative bands, 50-68 Mc, with the high power stations in the upper 10 Mc of that range. E-layer reflections are now discounted as being of negligible importance compared to the  $F_2$  reflections and those from the troposphere. As for tropospheric effects, experience has indicated that they become more serious as the frequency increases. Further study this summer will establish the facts.

The matter of coverage seems to favor the lower frequencies, but not unalterably so. High transmitting power is harder to get at 108 Mc than at 44, but our guess is that, with tubes shortly to become available, 50 kw can be obtained anywhere in this band. The question of field strength washes out. The volts-per-meter are higher as the frequency goes up but the length of the antenna decreases in proportion, so the developed voltage at the receiver terminals remains fixed for a given transmitter power, so long as free-space propagation is considered.

The effect of the earth's surface on propagation is, of course, pronounced. Further measurements are needed to establish the extent of absorption effects, but the diffraction effects are fairly evident. Shadows are sharper, and the diminution of signal strength beyond the horizon more rapid, as the frequency is increased. These matters can be proved in the coming months.

On the  $F_2$ -layer question, unfortunately, no proof can be forthcoming until the next sunspot maximum. In the meantime we must guess, by extrapolation from previous experience, what the effects will be. Of course the extrapolation procedure must be scrutinized with the greatest care, without professional bias or personal rancor, if we are to make a sound estimate.

# Broadcast Band

Use of boosters to fill in dead spots or extend coverage when a directional antenna system is not feasible. The unattended booster transmitter may be fed by r-f line as with WWDC or by space radiation as with WINX, using standard telephone lines for remote control

By

**ROSS H. BEVILLE**

Chief Engineer  
Station WWDC, Washington, D. C.

**M**UCH interest has been exhibited recently by broadcast engineers in a system of r-f signal reinforcement usually known as an r-f booster or a synchronous amplifier. Since late 1940 when the system was first used in connection with a standard broadcast station, it has proved both practical and of considerable benefit in the improvement of coverage in dead-spot areas and in aiding to override interference from other stations operating on the same or adjacent frequencies.

## Uses for Boosters

The use of a booster system is desirable for local-channel stations that are limited by FCC regulations to 250 watts or less and are not allowed to use a directional antenna

system, and for other stations even with directional antennas, to cover adequately an urban area having high noise level or absorption; WSAI is an example. A low-power station with several strategically located boosters can provide coverage comparable to that of a much higher-power station; such a system was planned for Worcester, Mass. but was shelved due to wartime restrictions.

Three booster systems are now in operation, two being in Washington, D. C. (WWDC and WINX) and one in Cincinnati (WSAI). A construction permit has been authorized for a fourth system, now

under construction at Ft. Benning, Ga., that will be operated as a satellite of WRBL in Columbus.

## How Boosters Function

Basically, an r-f booster as referred to here is nothing more than a linear amplifier receiving excitation in the form of modulated r-f power from the main transmitter and reradiating this signal by means of a suitable antenna system in an area in which the main transmitter field requires reinforcement. The difference between this and earlier work done in the synchronization of broadcast transmitters (WBZ and WBZA) is that an r-f booster has no oscillator or other frequency-generating apparatus and no modulators. It is automatically synchronous due to the fact that it receives excitation voltage from the output of the main transmitter and does not require modulation since this signal is already modulated.

From a practical standpoint the booster amplifier, antenna coupling unit and radiating antenna can be conventional in every respect, the only special consideration being that the booster amplifier be linear and very low in noise and distortion percentage. To accomplish this, all stages should be operated as closely to class A as is practical considering the power output requirements.

## Methods of Feeding Boosters

Since the booster transmitter must be a linear amplifier and has no frequency-generating apparatus, some means must be provided to deliver a sample of the modulated r-f output voltage from the main transmitter to be used as excitation voltage at the input of the booster amplifier. This can be done by land

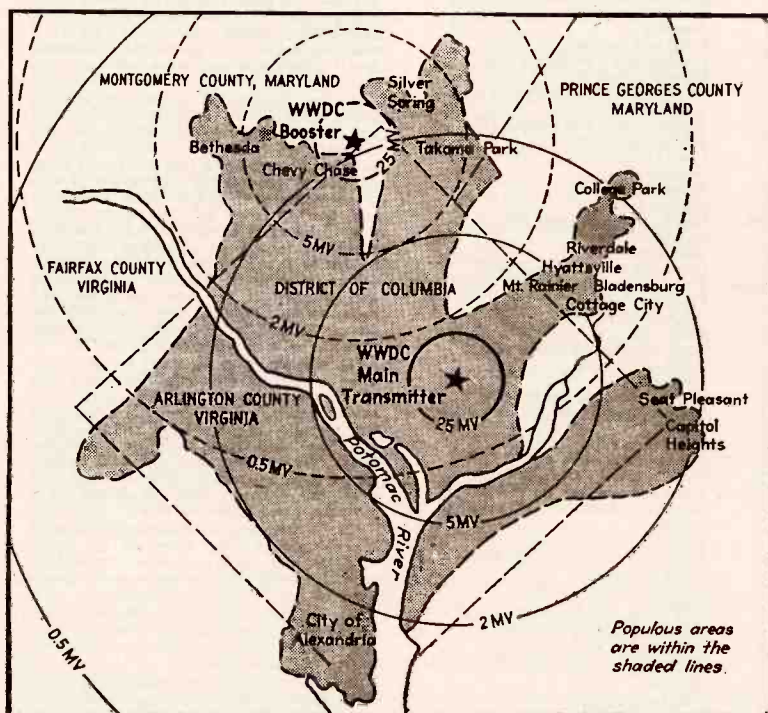
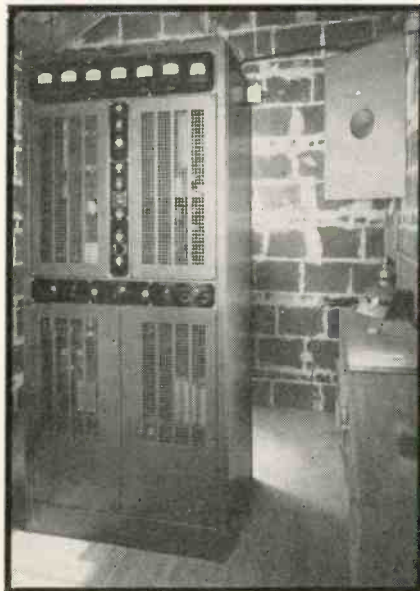

FIG. 1—Calculated field intensity contours of the WWDC main transmitter (solid lines) and booster transmitter (dash-dash lines)



# Satellite Transmitters



Left—WWDC main transmitter, with booster control panel mounted on the right side of the cabinet

Right—WWDC booster transmitter, unattended and operated by remote control from the main station

lines extending from the main transmitter to the booster or by space transmission whereby the signal from the main transmitter is received at the booster with a directional receiving antenna. A third method that has been suggested is modulation of a high-frequency relay transmitter with amplitude-modulated r-f voltage at the main transmitter, with subsequent demodulation by a receiver at the booster end. With suitable amplification this signal could then be reradiated to supply reinforcement to the main transmitter field. There is some question as to the practicability of this method due to the wide channel required for the relay transmitter.

## Proposed UHF Links

Many standard broadcast stations now operating, except those on clear channels, have areas where the signal-to-noise ratio could be improved or interference conditions alleviated, through the use of unattended satellite transmitters, according to Howard S. Frazier in testimony given recently before the Federal Communications Commission and abstracted here:

"Prior to the development of ultrahigh-frequency techniques, the use of satellite transmitters has not

been general due to the complexities of the equipment usually employed for the interconnecting control circuit and the economic factors involved. However, it is now believed practical to provide the connecting circuit between the controlling standard transmitter and the unattended satellite by the use of ultrahigh-frequency radio channels.

"It is proposed to use a very small portion of the antenna carrier current from the controlling transmitters for the double-sideband amplitude modulation of the high-frequency transmitter. The audio program would be present as secondary modulation. At the unattended satellite a high-frequency receiver would eliminate the high-frequency component and the resultant broadcast-frequency carrier would be amplified in order to drive the antenna of the satellite. It is proposed to use highly directive antennas with both the transmitter and the receiver.

"Equipment for this service should be inexpensive and not complicated from a technical standpoint. Some manufacturers have already had experience with equipment of this type in connection with other services. It is recognized that the location of satellite transmitters should be based on

sound engineering practice and that the location of the satellite and the amount of power radiated should be such that mush areas would be reduced to a minimum and would occur in areas where few listeners are located."

## WWDC Booster Uses Land-Line Feed

In the case of WWDC, land-line feed is used exclusively. Original calculations showed that if the main 250-watt transmitter were located in the business area of downtown Washington, the field strength in Northwest Washington, Chevy Chase, Maryland and Silver Spring, Maryland would be inadequate for proper coverage. It was obvious that the booster should be located near this area and a site was selected common to these points, approximately half-way between Silver Spring and Chevy Chase and just off the East-West Highway.

Then came one of the problems of this installation, routing of the r-f feed line from the main transmitter to this point. It was simplified to some extent by the availability of Western Union telegraph pole facilities along the B & O railroad right-of-way from the Washington Terminal to Silver Spring, a run of slightly more than six miles.

From Silver Spring over to the booster site was around 2.5 miles and from the Washington terminus of the Western Union facilities to the site selected for the main transmitter was a little over one mile. The problem of covering this latter span was a little more complex since no overhead facilities were available from the main transmitter to the Washington railroad yards.

It was planned to construct a

special open-wire transmission line on Western Union poles from the Washington railroad yards to the booster, following the B & O railroad to Silver Spring and then from there along East-West Highway on telephone line poles. This was arranged, but for the span from the main transmitter to the Washington railroad yards there was very little choice other than to use the underground cable facilities of Western Union. This was a standard No. 19 gage 26-pair lead cable of which the majority of the pairs were already in use by Western Union.

No special treatment was given the cable other than to select the best available pair after noise and leakage tests were made on the pairs open for use. The length of this cable is 7,762 feet and, surprisingly, the loss along this portion of the line is less than would normally be expected at this frequency (1450 kc). To date no difficulty has developed due to induction or cross-modulation effects.

The open-wire portion of the line consists of 8½ miles of No. 9 copper wire spaced 10.25 inches apart, presenting an approximate impedance of 700 ohms. The twisted pair in the lead cable measures 170 ohms at this frequency.

The loss in the entire line, which is over 10 miles long, is around 97

db. Approximately 29 watts is fed into the line from the final stage of the main transmitter, with approximately 2 millivolts being received at the booster end.

Coupling of the line to the main transmitter is accomplished by means of a variable capacitance which also provides a means for varying the amount of power fed into the line. A suitable matching transformer is used to couple the 170-ohm cable pair into the 700-ohm open wire transmission line. At the booster end, the line is terminated into a 700-ohm network, the output of which is link-coupled to the first stage of the transmitter.

#### Booster Amplifier Design

A modified Western Electric model 310B transmitter serves as the booster amplifier. The oscillator stage was removed and the coupling, the loading and the bias voltage of each succeeding stage was adjusted. Each stage was operated as closely to class A as possible while still obtaining the required 100 watts power output from the final with the excitation voltage available from the line. All stages are essentially class A with the exception of the final, which is class AB. In addition, a tuned circuit was substituted for the grid resistor in the first r-f

stage to give better coupling into the phasing network, and avc was added to the first stage to compensate for minor variations in excitation voltage.

For an audio monitor, the modulation amplifier was utilized and now supplies power not only to the monitor speaker but also to a line extending to the main transmitter for monitor purposes. The final stage is coupled in a conventional manner to a 150-foot Lehigh tower.

Figure 1 shows the calculated contours of both the main and booster transmitters. Measurements have shown, however, that the radiation efficiency of the booster antenna is not quite as great as calculated due to a limited ground system.

#### Remote Control Equipment

The entire WWDC booster plant is operated by remote control, as shown in Fig. 2. This is accomplished by means of three telephone circuits and a small r-f amplifier which is bridged across the main r-f transmission line and operates time-delay relays for the filament and plate switches. One pair of lines is used alone for the audio monitor circuit and the other two pairs are used in duplex with samples of plate current, plate voltage and antenna current appearing on duplicate meters at the main transmitter. The excitation voltage to the booster is controlled by variation of the input to the transmission line at the main transmitter.

The r-f amplifier circuit that controls the filament and plate switches is shown in Fig. 3, and is designed to actuate the filament switch relay immediately upon arrival of an r-f signal from the main transmitter over the transmission line. The plate switch relay operates approximately one minute later. These relays drop out when excitation voltage is removed from the line, thereby removing the possibility of the booster transmitter remaining on in case of line failure.

The r-f carrier signal arriving over the transmission line is amplified by  $VT_1$ . Tube  $VT_2$  is biased to cutoff, hence its plate circuit relay is inoperative with no carrier.

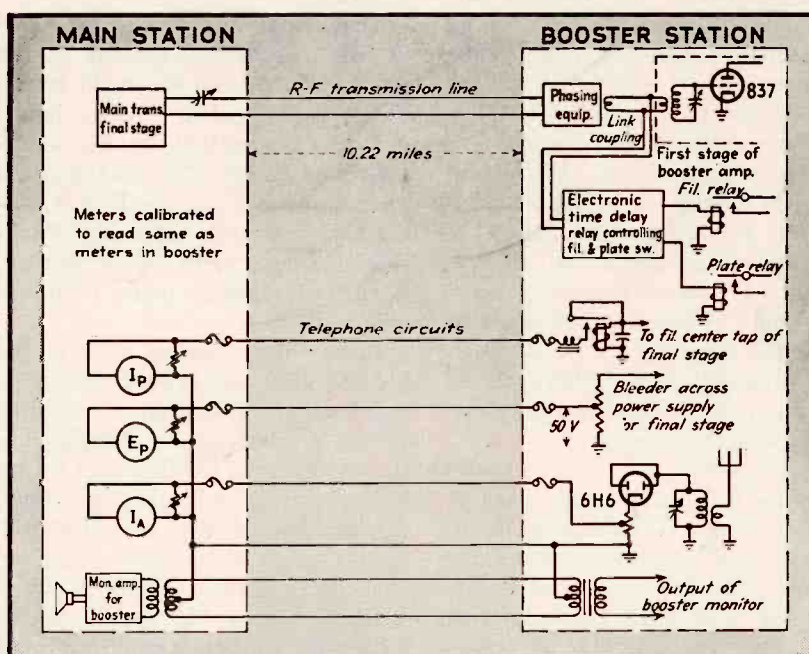

FIG. 2—Remote control system for WWDC booster transmitter

Arrival of the carrier overcomes this bias, making relay 1 operate and close the filament supply relay of the booster transmitter. Tube  $VT_3$  has a high negative bias when relay 1 is open (no carrier), amounting to half the plate supply voltage or 125 volts. Closing of relay 1 (on arrival of a carrier) shorts the resistor providing this negative bias, allowing the charge on the grid capacitor to leak off through the grid resistor to the point where  $VT_3$  draws enough plate current to operate relay 2 and apply plate power to the booster transmitter. The time delay of the grid circuit is made sufficiently long to permit heating of tube filaments.

### Space Transmission Method

The booster system originally installed at WINX, Washington, D. C., is an example of the method wherein the booster receives its signal through space rather than over wires. As with WWDC, original calculations showed that signal reinforcement would be required in Northwest Washington if the transmitter were to be located in the downtown area. A site for the booster transmitter was selected in an area approximately four and one half miles from the main transmitter, where the field from the main transmitter was calculated to be 2.5 millivolts. Later measurements proved this to be correct.

At the booster site, two receiving loops are oriented and phased to give a unidirectional pattern. The output of the loops is fed through a phasing network to a preamplifier consisting of two voltage stages and one 802 power stage. The output of this amplifier is then fed into a quarter-inch concentric line extending to the booster amplifier approximately 800 feet away, as shown in Fig. 4. At this point the line is terminated in another phasing network, the purpose of which is to synchronize the booster output with the main transmitter signal.

The WINX booster amplifier is of composite construction and has two stages—an 828, class A, driving two 203A tubes operating as class B, designed for 50 watts out-

put. This is coupled to the antenna in a conventional manner. The antenna itself is novel, consisting of a 125-foot brick smoke stack encased with four copper leads suspended from the top and bonded together top and bottom.

The booster amplifier is operated by remote control from the main station, as shown in Fig. 5. Four pairs of standard telephone wires are used in this control circuit. One pair provides a monitor circuit. Another pair actuates a reversible stepper relay to control the r-f input to the transmitter and with the third and fourth pairs also serves to read samples of plate current, antenna current and plate voltage and to operate the main power switch to the transmitter. This latter circuit is so arranged that the transmitter automatically shuts down in case of failure of the control circuit.

Closing the toggle switch at the main station actuates relay 1 at the booster station through telephone line 1, applying power to the booster transmitter and associated equipment. Lines 2 and 3 serve as return circuits for the remote plate current and antenna current meters when not in use as relay control circuits. Operating pushbutton 1 closes relay 2, making the stepper relay rotate one step in one direction and moving the arm of a potentiometer that controls the r-f output from the loops. Releasing and again depressing this pushbutton repeats the action.

Pressing pushbutton 2 closes relay 3 and causes the potentiometer to move in the opposite direction. The excitation voltage fed to the booster transmitter by its pickup loops can thus be controlled remotely by operation of pushbuttons 2 and 3 at the main station.

Lines 4, 5 and 6 carry samples of plate current, antenna current and plate voltage to the remote meters located at the main station. The booster monitor loop is excited by a portion of the booster monitor output and is terminated into the monitor system at the main station.

### Design of Pickup Loops

The most interesting portion of the WINX booster system is its method of feed by means of a directional receiving array. This is accomplished by taking advantage of the natural bidirectional characteristics of the loops and also by introducing sufficient electrical phase difference in addition to the physical spacing so as to discriminate against signals arriving from the rear of the array.

The loops are spaced approximately 35 feet apart or roughly 15 degrees at this frequency, and are mounted about 30 feet above ground. The physical arrangement is such that the two loops are lined up in the direction of the main transmitter but are at right angles to the booster antenna. With this arrangement the natural null of the loops is presented to

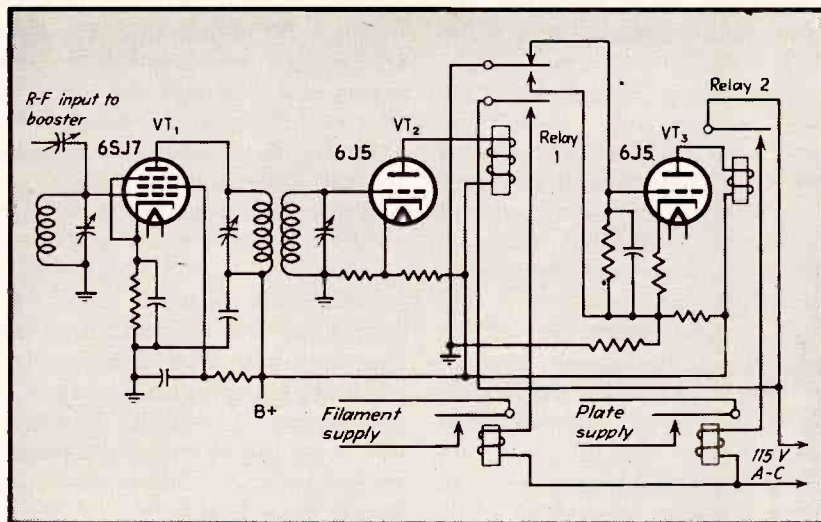

FIG. 3—Circuit of amplifier developed by C. R. Shaffer, Technical Supervisor of WWDC, to apply power automatically to the booster transmitter when a program signal arrives over the r-f transmission line from the main station

the booster antenna while the lobe of maximum pickup is in a plane with the main transmitter. Careful orientation gives rejection ratios between the main and booster transmitter signals of 10,000 to 1 or better. A rejection ratio of this order is critical and difficult to maintain, however, which is one of the principal objections to this system.

The physical dimensions of the loops are approximately two by four feet. They are constructed of two-conductor copper-shielded cable, with the two inner conductors cut and reconnected so as to form a two-turn loop. The outer shield is cut at the top and acts as an electrostatic shield. In the case of WINX the two loops were connected in series and then connected through the above-mentioned phasing network to the pre-amplifier.

#### Comparison of Line and Loop Methods

In evaluating the advantages and disadvantages of the two methods of excitation for the booster transmitter it appears that neither of the above systems offers the ideal solution. In the case of the WWDC land line feed, where open-wire transmission line is used, weather conditions cause variable line losses which are sometimes difficult to compensate for. Also, the cost of such a line is usually greater than that of receiving equipment. A concentric line between the two transmitters would minimize weather effects and provide an ideal system in other respects, but the cost would generally be prohibitively high. The transmission line method does offer greater stability than the loop method, however, and also provides a simpler means of control over the input where remote-control operation is utilized.

When the loop system is located close to the booster radiating antenna, as in the WINX system, adjustments become critical. As an example, suppose the loop system is located within the 200-millivolt area of the booster transmitter, where the field from the main transmitter is 2 millivolts. The signal ratio is 100 to 1 in favor of the booster. In order to provide

a signal ratio of 100 to 1 in favor of the weak signal from the main transmitter, which is the approximate ratio required for satisfactory performance, a rejection ratio of 10,000 to 1 would be required for the loop system.

While such a rejection ratio is entirely possible with careful adjustment of a well-designed loop system, many variable factors appear which make it difficult to keep such a system in adjustment. One of the greatest disadvantages of this system, however, is the pickup and reradiation of interference caused by other stations operating on the same frequency.

If the loop system is located in an area where the signal strength from the main station is below that required to override all interference, then reradiation of interference becomes serious. In a two-loop array with outputs phased so as to approximate a unidirectional receiving pattern, interference is

with the booster transmitter by means of telephone cable or, if possible, concentric line. This should greatly reduce the interference problem, reduce the cost of line installation and also materially increase the stability of the loop system due to the increased distance between it and the booster transmitter.

#### Control of Mush Areas

The principal disadvantage with any booster station is the resulting mush areas. They are not limited to areas between the two transmitters, and are dependent to a great extent upon the ratio of the power output of the booster transmitter to the power output of the main transmitter. In some cases, where the power ratio is considerably in favor of the main transmitter and where no phasing network is utilized to put the two signals in step at points beyond the booster transmitter, the mush areas may completely surround the booster and will appear at any point where the two signals are of equal intensity and displaced as to phase.

It is not essential that the main and booster transmitters be operated in phase, but in most cases better results can be obtained when they are. Inphase operation is used at WWDC and WINX, eliminating mush areas beyond the booster. Generally speaking, when the booster output is low in comparison to that of the main transmitter and the booster is located in an area subject to high absorption (as with WSAI), mush areas will completely surround the booster if phasing is not used.

Selection of the power ratio is important in that it provides a means by which the mush areas can be controlled to some extent. If care is exercised in the selection of this ratio, the mush areas can be made to fall, for the greater part, in predetermined areas which in some cases may be thinly populated or in some way not so desirable from a coverage standpoint as others. There are other factors involved in making this determination, such as variable soil conductivity between the two transmitters and the efficiency of the two antennas, but with normal antenna efficiency in each case, the actual

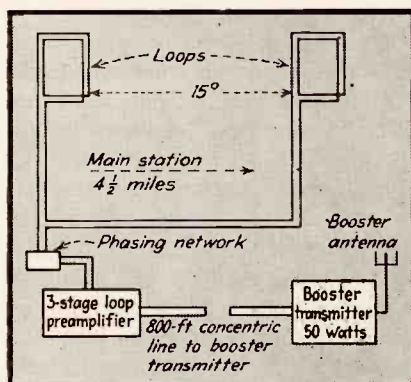

FIG. 4—Block diagram of WINX booster system, which obtains its r-f signal through space with a pair of loops beamed at the main transmitter

eliminated to some extent but signals arriving at a high angle cause a great deal of trouble. Also, signals appearing at approximately 45 and 135 degrees on each side of the main axis can and do cause difficulty. The advantages of the loop system lie in economy of installation and elimination of long-line maintenance.

Possibly the best practical method of feed would be a combination of the two systems whereby a single loop is located in a heavy field from the main transmitter, at some distance from the booster transmitter, and connected

output of the two transmitters will be the dominant factor.

### Causes of Distortion

Mush areas are roughly a half wavelength wide and are found at points at which the main and booster transmitter signals are of equal or nearly equal intensity and are opposite in phase. In these areas, cancellation or partial cancellation of the two signals occurs and the resultant appears as a considerably weakened signal accompanied by distortion of the audio component. The amount of distortion is dependent principally upon (1) distortion introduced by the booster amplifier, and (2) distortion occurring as a result of phase differences between the two r-f signals.

Distortion occurring as a result of the first case can be partially controlled by careful design and adjustment of the booster amplifier, and will considerably reduce the mush area. For example, assume a theoretical amplifier completely free of distortion. With such an amplifier the modulated r-f excitation voltage would be reradiated from the booster antenna with no change in the wave form other than an increase in amplitude. With an exact 180-degree phase displacement at a point of equal field intensity from the main and booster transmitters, complete cancellation of the two signals would occur. Still assuming 180-degree phase displacement, at any point other than one in which the two signals are exactly equal there would be a weakened signal but no distortion of the audio component.

Now consider the practical case where some distortion is introduced by the booster. In this case the two r-f envelopes are not the same and only that portion of the booster signal which originated with the main transmitter will be cancelled, leaving the distortion to appear as a small but greatly over-modulated r-f signal. The amount of this distortion will to a great extent control the width of the over-all mush area since for every half-wavelength, where the two signals are approximately equal, there will be cancellation to the extent that they approach each other in amplitude.

If the distortion present is small in comparison to the resultant signal, then the mush areas will be small and sharply defined. Under normal circumstances mush areas tend to disappear when the ratio between the two signals is of the order of 2 to 1 or more. If the distortion percentage is large, however, the area over which this condition will be noticeable will be increased proportionately. This is important, since by maintaining the booster transmitter with as low a percentage of distortion as is practicable, the area over which this condition is prevalent can be reduced to a minimum.

### Phase Considerations

In the above, only the half cycle which was exactly out of phase with the main transmitter signal has been considered. The following half cycle, due to the two signals traveling in opposite directions, will be in phase and the two voltages will add, causing no particular difficulty.

The above analysis also assumes an exact 180-degree phase displacement. This would occur normally only on a straight line between the two transmitters (or on this same line extended beyond either transmitter if phasing equipment is not used) and not necessarily at a point of equal signal intensity.

It is not likely that any point could be found at which complete

cancellation of the two signals occurs, because when they are equal in amplitude they are generally not exactly 180 degrees out of phase. At any point off this theoretical line, the phase angle between the two signals becomes less than 180 degrees. At such points and along the line of approximately equal signal intensities, phase distortion of the modulated r-f envelope is most apparent and results in a distorted audio component. This is by far the most serious of the causes for mush areas since no method of control has yet been devised. No amount of phasing equipment will put the two signals in phase at all points between the two transmitters.

### Conclusion

In summation, it may appear that a negative viewpoint has been adopted as to the use of boosters due to the mush areas involved. On the contrary, it is felt that amplifiers of this type may in many cases be the solution to the dead spot and interference problems of many broadcast stations. Actually, mush areas cover only a very small percentage of the service area of a station and in many cases these can be made to fall in areas not considered of great importance from a coverage standpoint. The additional service rendered by such an installation greatly offsets any disadvantage occasioned by its use.

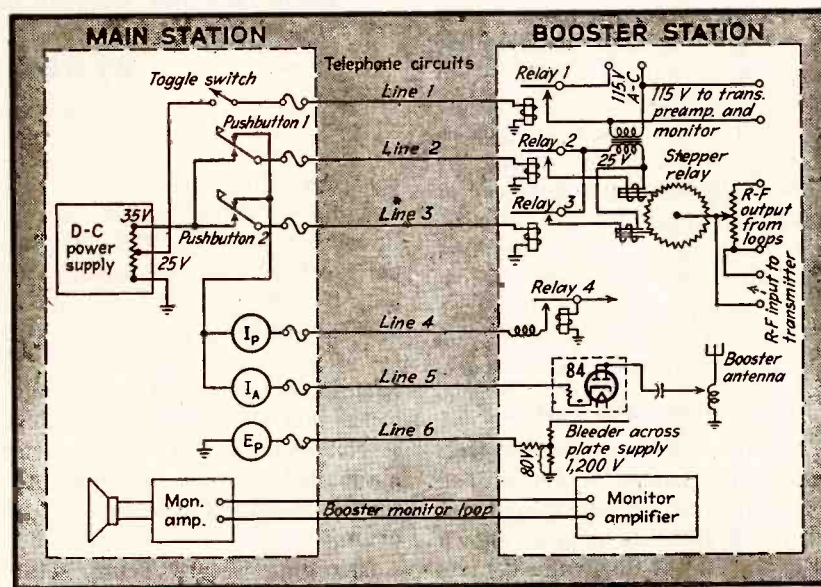
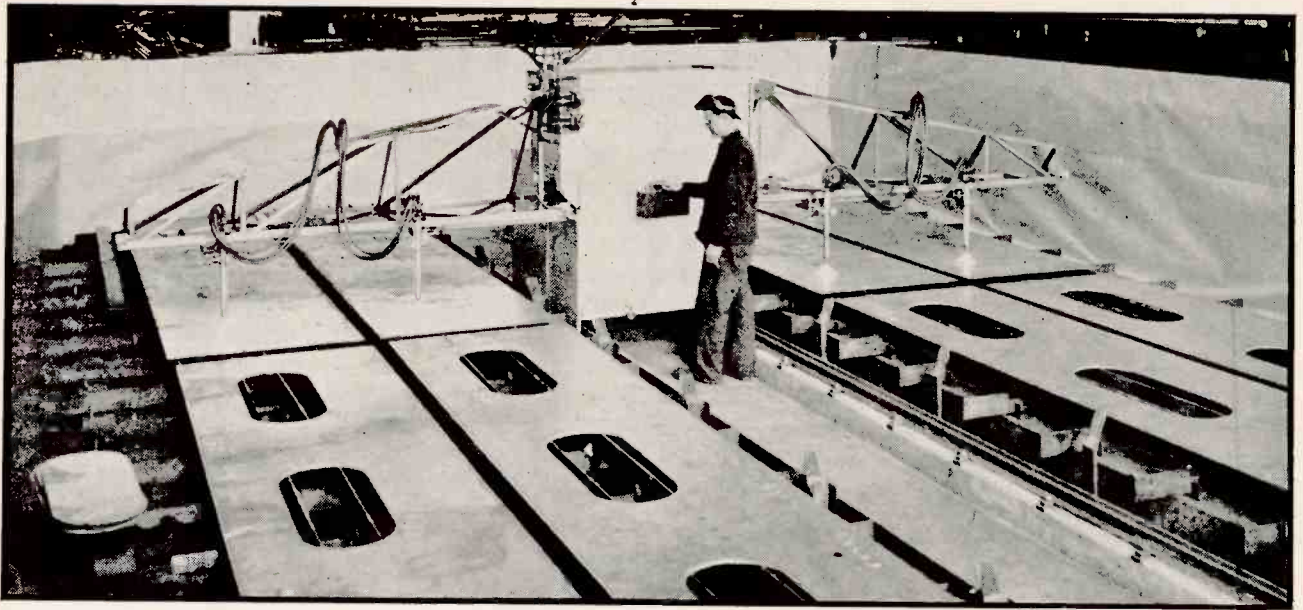

FIG. 5—Remote control system for WINX booster transmitter, using four pairs of standard telephone lines. Relay 4 connects line 4 to the high side of the overload relay in the filament center-tap of the final stage



Four-torch electronically positioned flame cutter being used to cut weight-reducing holes in girder frame members for a rayon spinning machine. The torches have already completed cutting of the four pieces in the foreground, and have accurately trimmed all four edges of the pieces about to be perforated

# Phototube-Controlled

**A**UTOMATIC control in oxyacetylene flame cutting of steel shapes on a mass-production basis is achieved with the ISC flame cutter by using electronic control. The flame cutter has been in continued use in shipyards and machine fabrication plants for over three years. The system utilizes photoelectric control in a unique manner that eliminates the follower or outline-tracer requiring full-size templates.

Templates for flame cutting by commercially developed follower or manual tracer systems are full size, some being more than seven feet wide and thirty feet long. Fabricating, repairing and storing such templates is quite expensive and requires a great deal of floor space.

## Four Drums Guide Cutters

The outline to be cut by the electronic flame cutter is determined by markings or reflecting spots on four black Bakelite drums, shown in Fig. 1. Two of the drums control the action of the longitudinal drive motor, and the other two control the transverse drive motor. One set of four drums has sufficient space

Electronic control makes possible accurate oxyacetylene cutting of large steel sheets on a mass-production basis, using photoelectric scanning of small master drums in place of conventional contour tracing of costly full-size master patterns

By **DAVID S. WALKER**

*Chief Engineer  
Industrial Scientific Co., New York*

for controlling the actions of the machine to between 100 and 200 lineal feet of cut. The available cutting length on one set of drums may be used to make up the control for one large piece to be cut, or for several smaller shapes. The changeover from cutting one shape to another on the same drum is accomplished by setting the drums manually so that the phototube scans the proper section of the drum.

Changing record drum sets is simple. Each drum is set-screwed to its holder. Unloosening the set screws allows the drums to be removed and the new set to be placed

on the holders. Drums do not wear out, as scanning with a light beam eliminates any surface wear on the records. The drums are lightweight paper-base phenolic cylinders with a dull black surface.

## Operating Principle

The method of operation is based on the resolution of any shape into its Cartesian coordinates. Considering longitudinal cuts as being along the Y axis and transverse cuts as being along the X axis, any cut along a diagonal is determined by its projection on both the X and Y axes. Longitudinal movements are controlled by one distance drum

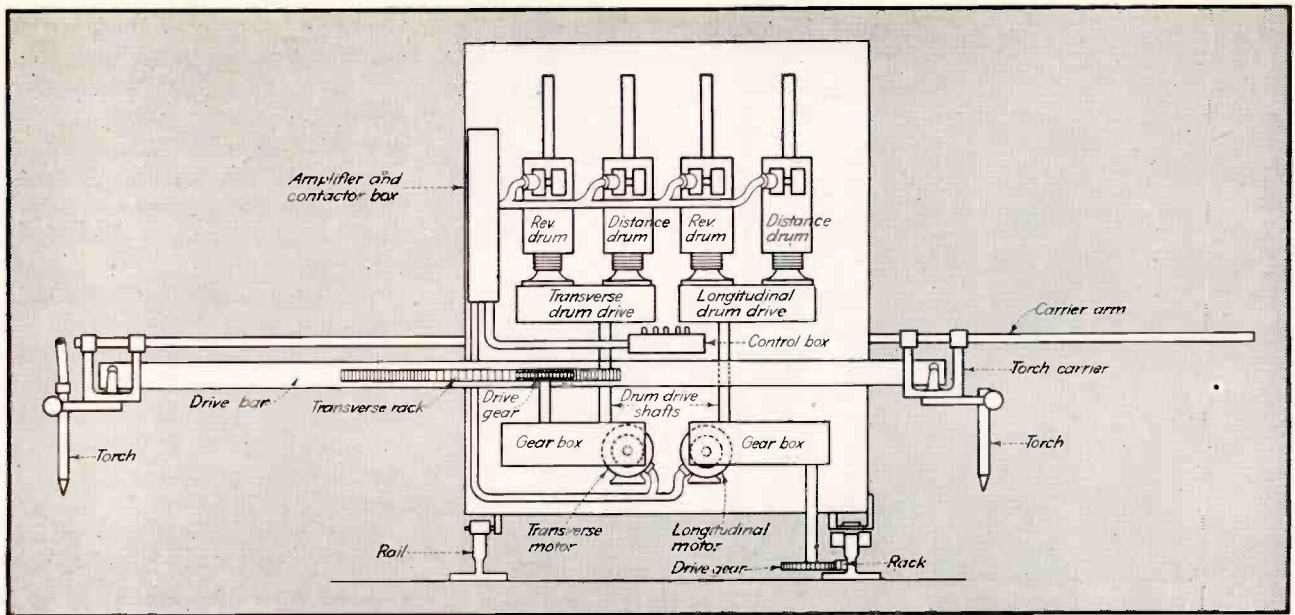

Sketch showing relationship of major elements of the flame cutter. Additional torches may be added, for simultaneous cutting of four or more pieces. On large, intricate shapes requiring high accuracy, it has been found economical to prepare master drums for production runs as small as 12 pieces

# Flame Cutter

and one reversal drum, and transverse movements are controlled by the other two drums. As an illustration of how the drums control the movement of the cutting

torches, when the two longitudinal drums are black the torches may be moving longitudinally in one direction and cutting a straight line. Arrival of the scanner at a white

dot on the longitudinal distance drum stops the longitudinal drive motor and starts the transverse drive motor. Now if the scanner on the transverse distance drum reaches a white dot soon, the transverse motor stops and the longitudinal motor starts again in the same direction as before. Repetition of this process at equal very short intervals gives a zig-zag torch motion corresponding to a cut on a straight line at 45 degrees, while unequal and varying intervals produce torch motion along curves. Arrival of either of the reversal scanners at a white area causes the corresponding motor to travel in the reverse direction thereafter.

All four drums are inscribed simultaneously with jeweled styli by a step-by-step process while the scribing machine is tracing a sample of the finished product, and the controlling markings are later filled in with white ink to make them light-reflecting. In describing a curve or diagonal cut, intervals are taken to most nearly approximate the instantaneous slope. In tracing curves, the intervals may be

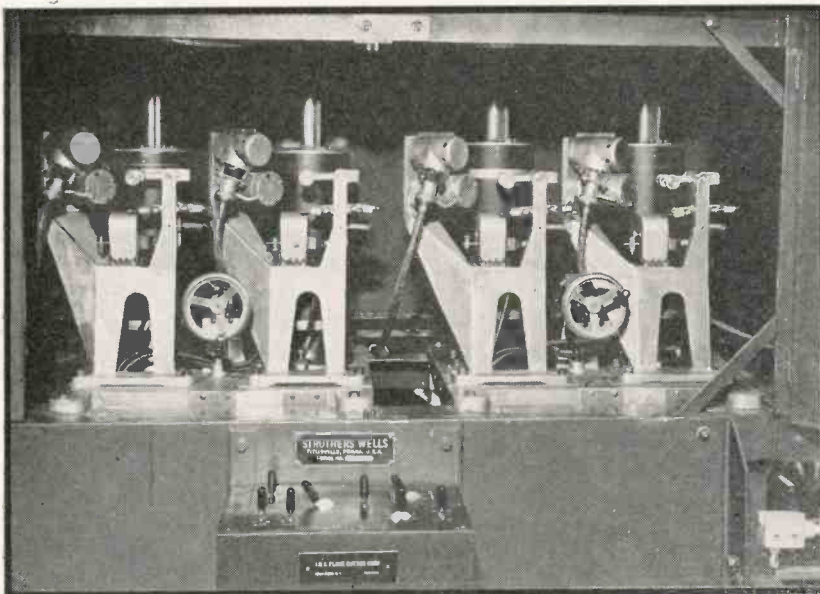
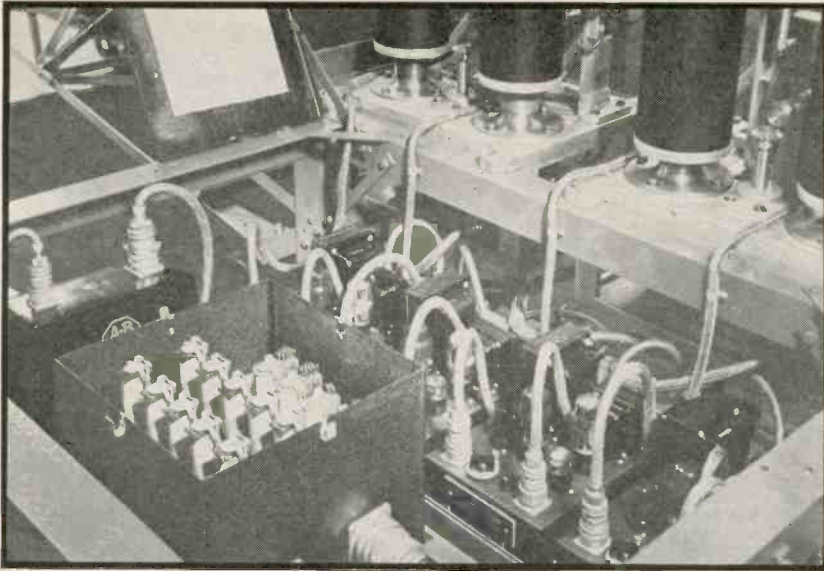

FIG. 1—Control drums and scanning heads of the flame cutter. Longitudinal and transverse travel drums have many white reflecting dots in this setup, for cutting curved objects. The drive motors may start and stop as often as 100 times per minute. The two reversing drums have relatively large alternate areas of black and white



View of the four amplifiers and the relay box, with master drums in background

very small in order to follow faithfully the instantaneous slope, while in straight-line cuts the interval may be of any desired length.

#### Scanning Apparatus

The photoelectric pickup units are in cast aluminum housings. Each exciter lamp and its associated optical system projects a small spot of light on its drum. The reflecting surface allows a large part of the incident light to be reflected onto the cathode of the phototube. The system employs accurately ground lenses in both projector and pickup units so that there is in practice no interference from stray light.

Control impulses from the four scanners go through low-capacitance cables to four amplifiers which are of the direct-coupled type, as the machine must operate equally well at very low speeds and at speeds in excess of 24 inches per minute. Control frequencies range from zero to 100 square-wave cycles per second.

#### Amplifier Circuit

Each amplifier circuit utilizes a 921 phototube feeding into a 6SJ7 amplifier which in turn is directly coupled to a 6V6 output tube driving a telephone-type d-c plug-in relay, as shown in Fig. 2. One type 80 and one type 6H6 form the power supply. Line voltage regulation is provided to minimize vari-

ations in supply voltage. The 921 phototube has its cathode grounded, necessitating an additional voltage supply. The few extra components needed for the additional supply are more than justified by the higher frequency response due to comparatively low anode-ground capacitance. Polarizing voltage on the phototube and plate voltage of the 6SJ7 are both 80 volts. This value is well under the ionization potential of the gaseous type cell, insuring fairly constant response with the wide variations in cell temperature. The low plate voltage also achieves good voltage sensitivity on the 6SJ7; a very small negative grid voltage will completely cut off the tube.

The 6SJ7 actually operates very near to zero bias with no light on the phototube, with potentiometer  $R_1$  taking care of variations in dark current when replacing the phototube. Thus, when no light falls on the phototube there is minimum bias on the 6SJ7 and maximum current flows in the first amplifier plate circuit. Light falling on the phototube anode decreases its internal resistance, allowing more current to flow, and produces a voltage drop in resistor  $R_1$  which is both phototube load resistor and amplifier grid resistor. The resultant negative bias cuts off the 6SJ7.

The sharp cutoff characteristic of the 6SJ7 and the low plate operating voltage together allow con-

siderable latitude in bias for cut-off. Since the amplifier serves as a sensitive switch with no linear response necessary between output and input, wide variations are permissible in bias setting, phototube sensitivity, line voltage and exciter-lamp output without influencing performance.

The plate current of the 6SJ7 is thus seen to be always either zero or the value corresponding to zero bias for load resistor  $R_2$ , which is also the grid resistor for the 6V6. In controlling the 6V6, overswinging the grid insures stable operation.

If the phototube is dark, current flows in the 6SJ7 plate circuit, causing a voltage drop in  $R_2$  which in turn cuts off the 6V6. Conversely, when light is incident on the phototube, the 6SJ7 is cut off and the plate current of the 6V6 is determined by the plate voltage and the resistance of the relay coil. A 10,000-ohm resistance value for  $R_3$  limits voltage surges when the magnetic field of the relay collapses.

#### Power Supplies

The direct-coupled amplifier as described above has very good square-wave response, with the upper frequency limit determined principally by the inductance of the relay used in the output circuit. Well-filtered power supplies are necessary to achieve both the fast action required of the relay and the high sensitivity of the pickup.

The power supply for the output tube is a conventional full-wave rectifier feeding into an L-type filter. The other two power supplies in each amplifier are designed to take advantage of the low power drain required. A 6H6 is used in conjunction with a center-tapped winding on the power transformer to provide two independent, equal half-wave rectified voltages in series. Each voltage source has a filter comprising a 10,000-ohm resistor and two 8- $\mu$ f capacitors. Total bleeder current, including capacitor leakage, is over 3 ma, while the 921 phototube requires only a few microamperes and the 6SJ7 a little over 1 ma. Resistor-capacitor filtering provides cheap, compact and dependable filtering in these ranges.



All amplifiers are interchangeable so that one spare amplifier is all that is needed to assure continued operation should any one of the four amplifiers in the machine become inoperative. Unplugging the two AN connectors of an amplifier allows it to be removed for inspection and the spare amplifier assures that there is no holdup in production. The power supply for all four amplifiers is so inter-connected that none will operate unless all four are plugged in.

The control impulses of the four d-c relays actuate the a-c telephone-type relays and their associated contactors in such a way that the required sequence of operations of the motors is achieved.

The final drive is through two specially designed three-quarter horsepower three-phase induction motors capable of making more than a hundred stops and starts a minute. Positive stopping without overtravel is assured by the use of plugging switches. The drive motors are coupled directly to the record drums and to the longitudinal and transverse racks so that the record drums always rotate in synchronism with the movements of the torches.

The torches travel in a transverse direction along arms project-

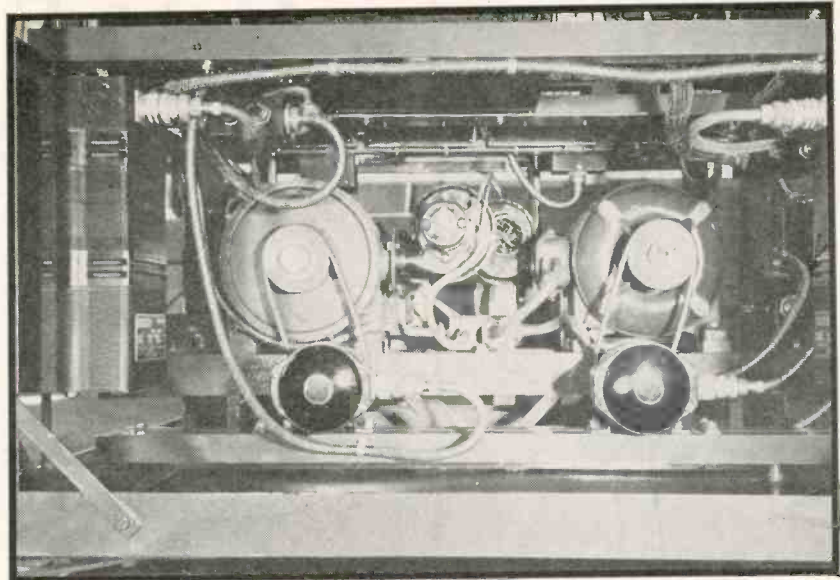

Transverse and longitudinal driving motors. The voltage-regulating transformer at the left serves the a-c contactors and the amplifiers

ing from the machine. Longitudinal travel of the torches is achieved by moving the entire machine on its rails.

The operator can position the torches electrically through lever switches provided. There is an interlock which cuts out all automatic functions while positioning.

When the torches are all lined up and the work preheated, the operator flips the lever to automatic

operation. He need not touch the control box again until the entire piece has been cut, at which time he presses the stop lever. During all the intervening time he may give his full attention to the torches, regulating them so that the best cut is achieved. Up to sixteen torches may be used. Stoppages from torches blowing out are reduced not only because the operator can give them his full attention but also because of the uniform speed of cut.

#### Maintenance is Simplified

Operation under mill conditions has proved the advantages of plug-in components, not only in reducing outage time but in the ability of plant men, unskilled in electronics or electrical controls, to make replacements themselves. It is no more difficult for them to replace a defective amplifier or relay than to change tubes in a radio.

The flame cutter has proven itself in operation to have many advantages over machines doing comparable work. It produces at least four times as much in cutting any given shape in comparison with other machines. Accuracy of cut is unequaled by any other method, as every movement, even to the smallest increment, is positively controlled. Operator fatigue is reduced to a minimum. Finally, electronic control gives a wear-free, unchanging record.

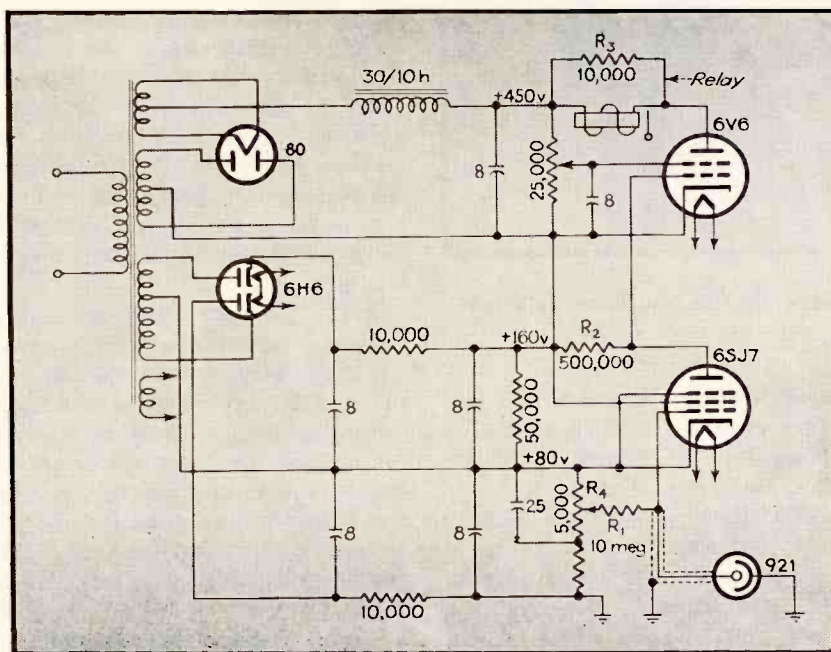
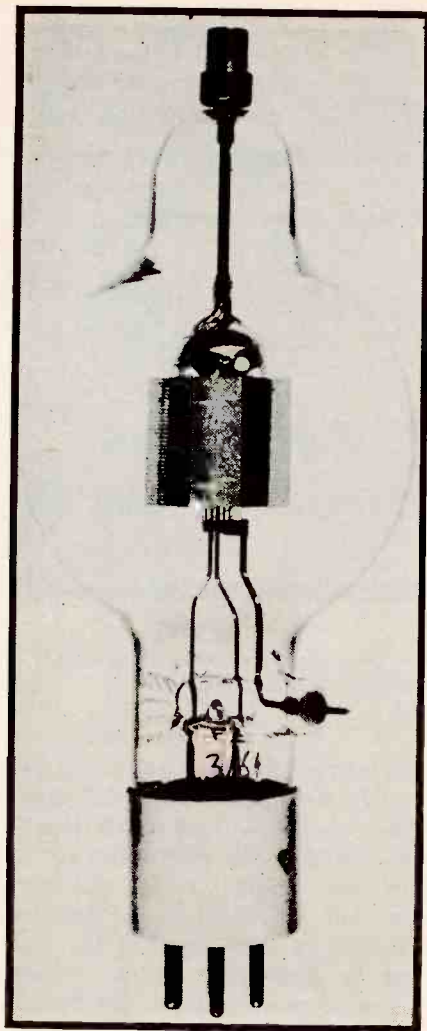

FIG. 2—Schematic circuit diagram of amplifier serving the phototube of one of the drums. All four amplifiers are identical. The output relay controls other contactors in the driving motor circuits.

# Grid Emission in



Eimac type 100T tube used as a guinea pig in many of the tests discussed here

**T**HIS ARTICLE deals with the problem of electron emission from the control grid in a high-vacuum triode having a thoriated-tungsten filament. The specific type of cathode employed is early mentioned, because emission from the grid is directly tied up with the nature of the active material on the cathode. The remedy for grid emission in a tube having a thoriated filament, for example, is not necessarily the answer to grid emission troubles in a tube containing an oxide-coated cathode.

In its broader aspects the question involves the suppression of emission from an electrode whose normal function is best performed by selective emission, or no emission at all. The term selective emission is advisedly used because there can be two distinct kinds of emission from

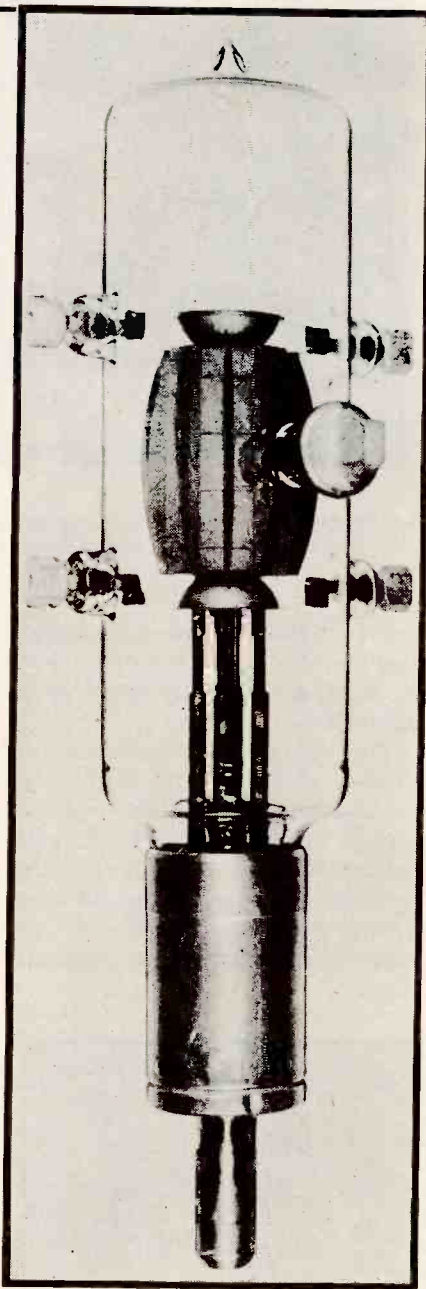

Type 527 tube, employing an X-grid

a grid: primary emission and secondary emission. Much confusion has resulted by failure to distinguish between these, and to identify their causes and effects. Since electrons leave the grid by both primary and secondary mechanisms, like effects under certain conditions would naturally be expected. That the effects are not always the same has led to one cause being mistaken

for the other in a great many cases.

The primary electrons about which we are concerned are those emitted by reason of the fact that the grid runs at an elevated temperature; in other words, thermionic emission from grid. Grid heating in a power triode is caused by electron bombardment of the grid during its positive excursions, and also by thermal radiation from the filament and plate. Since primary emission from the grid is a function of grid temperature, such primary electrons as are emitted leave the grid continuously during operation of the tube. As with other continuous processes based on temperature, the effects are cumulative. This matter of continuity of emission is worth keeping in mind while distinguishing between primary and secondary emission from a grid. Mouromtseff and Kozanowski<sup>1</sup> describe a simple circuit for measuring primary emission.

## Primary and Secondary Emission Effects

By definition, secondary electrons are those released from the grid under the impact of electrons originating from another source, such as the filament. Since the grid is bombarded when positive with respect to the filament, secondary emission occurs only during the positive half-cycle of the grid driving-voltage. Being a discontinuous process, the direct effects of secondary emission are not cumulative.

Both primary and secondary emission reduce the grid current when power tubes are operated in the positive-grid region, and may cause the grid current to reverse its normal direction of flow. In grid-leak bias circuits this results in a loss of bias, accompanied by increased plate current. The primary component of grid emission is the bad actor in this case, because a vicious circle is started. The increased plate current causes increased plate temperature, which in turn raises the grid temperature,

# Vacuum Tubes

Causes and effects of primary and secondary emission are discussed. Emission photographs of various materials, taken with an electron microscope, are presented. Tests which resulted in the development of a special grid are described

By **HAROLD E. SORG** and **GEORGE A. BECKER**

*Director of Laboratory*

*Research Engineer*

*Eitel McCullough, Inc., San Bruno, Calif.*

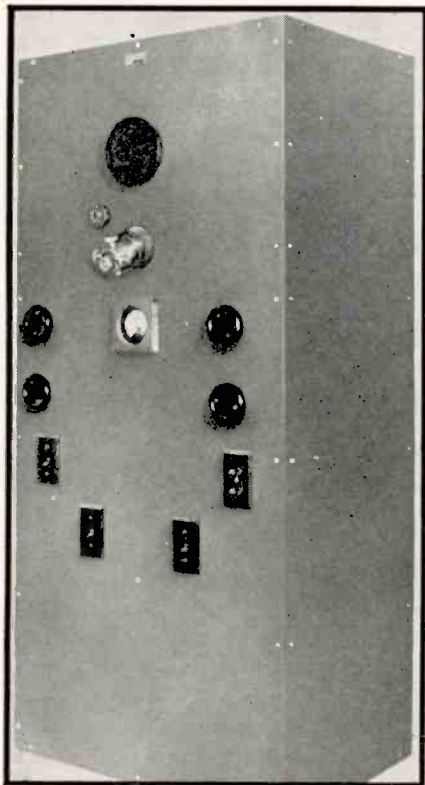

FIG. 1—Special electron-microscope developed to take emission photographs. The instrument is shown schematically in Fig. 2

causing further increase in primary emission from the grid. The effect is cumulative, and once the grid current starts to drop the grid may lose control, allowing the tube to run away.

The effects of secondary grid-emission are less obvious. Secondary electrons are emitted by reason of electron bombardment from the filament, which occurs only during the positive half-cycle of the grid driving-voltage. The effects are not cumulative and, if primary emission

is under control, can be beneficial because the grid current is reduced and hence the grid driving-power lowered. This apparent something-for-nothing is frequently accompanied by instability of operation, however, the tendency toward dynatron-type parasitic oscillation being enhanced. The effects of secondary emission from a control grid may be summed up by saying that secondary electrons are beneficial if moderate, but can lead to instability if excessive. For practical purposes the ideal control-grid is one which exhibits no primary emission and negligible secondary emission.

### Metallurgy Provides the Key

Several years ago it was recognized that unless a solution could be found for the grid-emission problem, a serious barrier stood in the path of power-tube development, where grid temperature is an important factor. While experiment-

ing with high-vacuum tubes having thoriated-tungsten filaments and grids of refractory metals, such as tantalum and molybdenum, it was observed that primary grid-emission was materially increased by activation of the grid with thorium sputtered or otherwise deposited from the filament. After a period of operation these tubes were found to contain not only a thoriated filament but also a thoriumized grid. So activated, the grid developed primary emission.

A reverse phenomenon was also occasionally observed in the case of the filament. Some sort of contamination was reaching the filament, killing its emission. This was interesting. If something would poison the emission of a thoriated filament, why wouldn't the same thing be good for the unhappily thoriumized-grid? With this key the search went on, resulting in the perfection of what is now known as the X-grid. Initial development work was done by Wil-

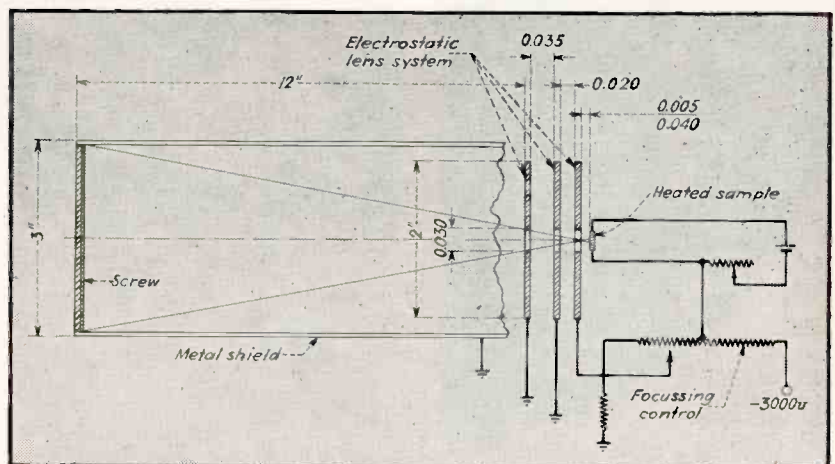

FIG. 2—Schematic of the special electron microscope pictured in Fig. 1

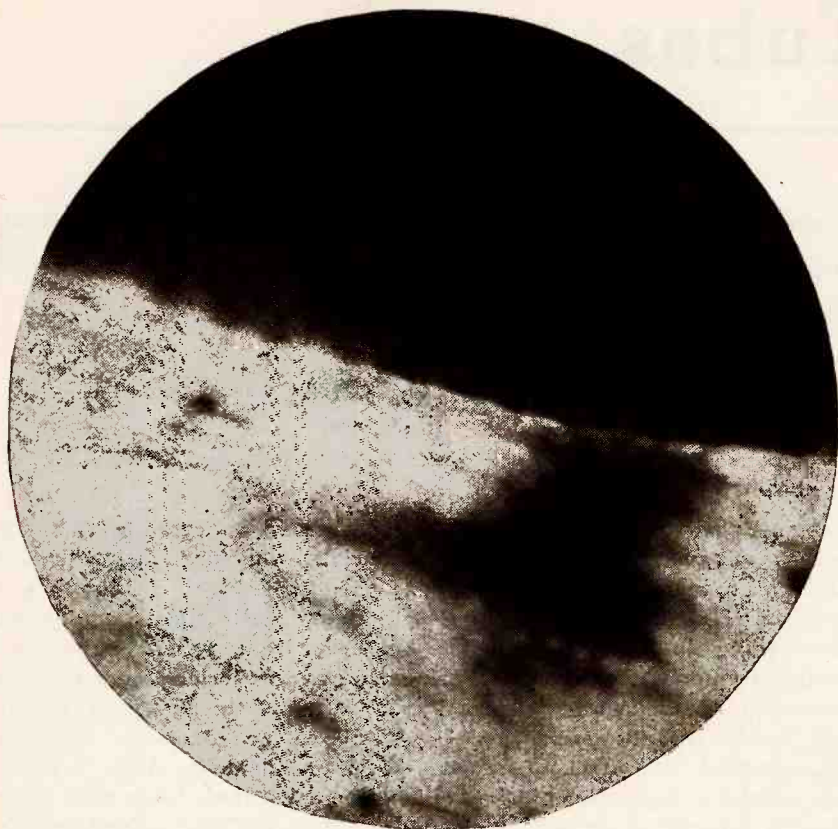

FIG. 3—Emission photograph of thoriated tungsten, taken at 1300 deg C. In this instance an edge of the sample was photographed, so that emission streamers are visible

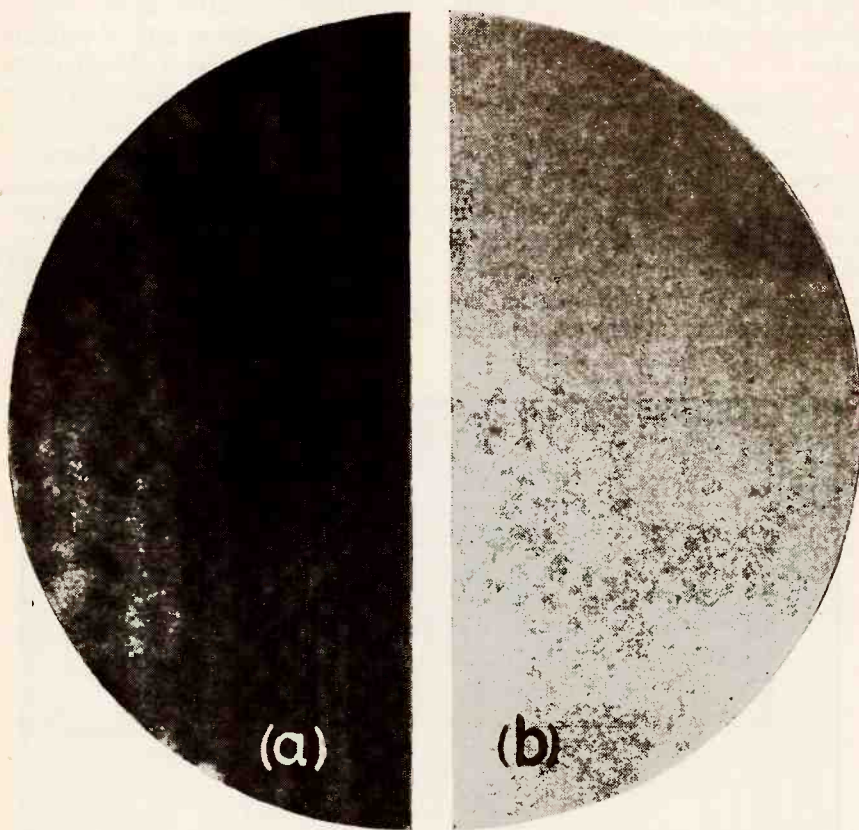

FIG. 4—(a) Emission photograph of pure tantalum, taken at 1500 deg C, and (b) at 1700 deg C. Half-photographs are shown adjacent to each other to conserve space and facilitate comparison

liam W. Eitel and Jack A. McCullough. While the X-grid was developed principally to overcome primary emission, it fortunately also exhibits a low order of secondary emission.

During the course of the investigation the emission properties of numerous metals other than tantalum and molybdenum were studied. Platinum has unique properties and deserves special mention. If properly handled in tube manufacture a platinum grid will exhibit little or no primary emission during subsequent life of the tube. Resistance of platinum to activation by thorium is apparently due to an absorption phenomenon. The principal disadvantages of platinum, aside from the element of cost, are its relatively low melting-point, its poor mechanical strength compared to the more refractory metals, and its relatively high secondary-emission properties.

#### Special Electron Microscope Used

Much of the subject work on grid emission was done with the aid of a special electron-microscope. Figure 1 shows a photograph of the complete unit and Fig. 2 is a diagrammatic view of the essential parts. This unit provides means for visual examination of electron emission from any desired metal, and the effects of contaminants thereon, at any desired temperature. For example, a specimen containing thorium can be mounted adjacent to a specimen of grid material, and the latter contaminated with thorium vaporized from the former. The emission properties of the contaminated grid material may then be studied. Emission patterns are directly observed on the screen. For later study and record purposes, photographs and even moving pictures can be taken of the specimens.

A series of emission photographs taken with the electron microscope are illustrated. (*Ed. Note:* All emission photographs reproduced here were originally taken at a magnification of 125. As reproduced, however, they represent a magnification of about 100.)

Figure 3 shows the emission pattern of ordinary thoriated tungsten. This photograph is included here

merely because thoriated tungsten is a familiar type of emitter material and serves as a reference for comparison purposes. The photograph was taken with the specimen at 1300 deg C; all temperatures herein being brightness temperatures as indicated by an optical pyrometer. The light areas in the photograph are the actual traces produced on the screen by primary electrons emitted from the sample, the darker areas indicating a lack of emission. This particular photograph happens to show an edge of the specimen, and the streamers present constitute electron emission from the edge.

Figures 4 (a) and 4 (b) show emission patterns of the surface of pure tantalum at 1500 deg C and 1700 deg C, respectively. Figures 5 (a) and 5 (b) show similar patterns of pure molybdenum at like temperatures. It is evident that tantalum exhibits somewhat higher primary emission than does molybdenum at a corresponding temperature. The pronounced increase in emission from both metals, for an increase of 200 deg C in the temperature region indicated, is worth noting.

Figure 6 shows the emission pattern of a sample of tantalum contaminated with thorium at 1400 deg C, the streamers visible being from an edge of the sample. The tremendous increase in primary emission seen in comparison with Fig. 4 (a) explains why a tantalum grid used with a thoriated filament often causes a tube to run away during operation. Molybdenum exhibits a similar increase in primary emission upon contamination with thorium. Curves in Fig. 7 illustrate the effects of this contamination in a tube.

Figure 8 shows the emission pattern at 1700 deg C of the surface of a sample of tantalum partially treated by the X-process. The lighter area at the left in the photograph constitutes the emission from the pure tantalum, and the darker area at the right indicates the absence of emission from the treated portion of the sample. Since the X-processed material is seen to have a lower order of primary or thermionic emission than either tantalum or molybdenum, one would expect it to have

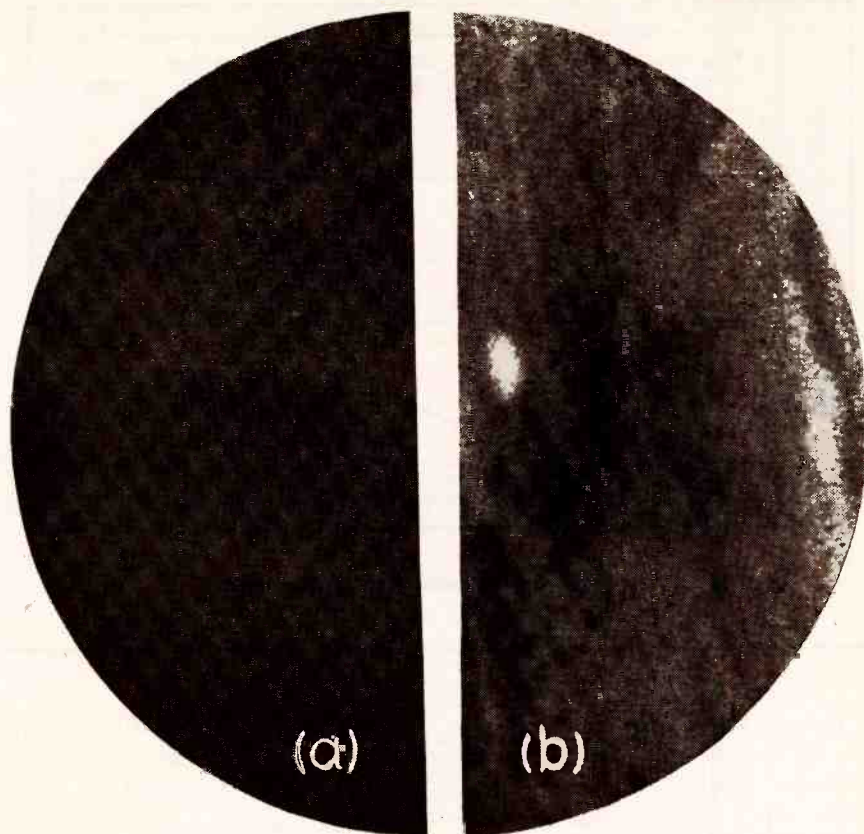

FIG. 5—(a) Emission photograph of pure molybdenum, taken at 1500 deg C, and (b) at 1700 deg C

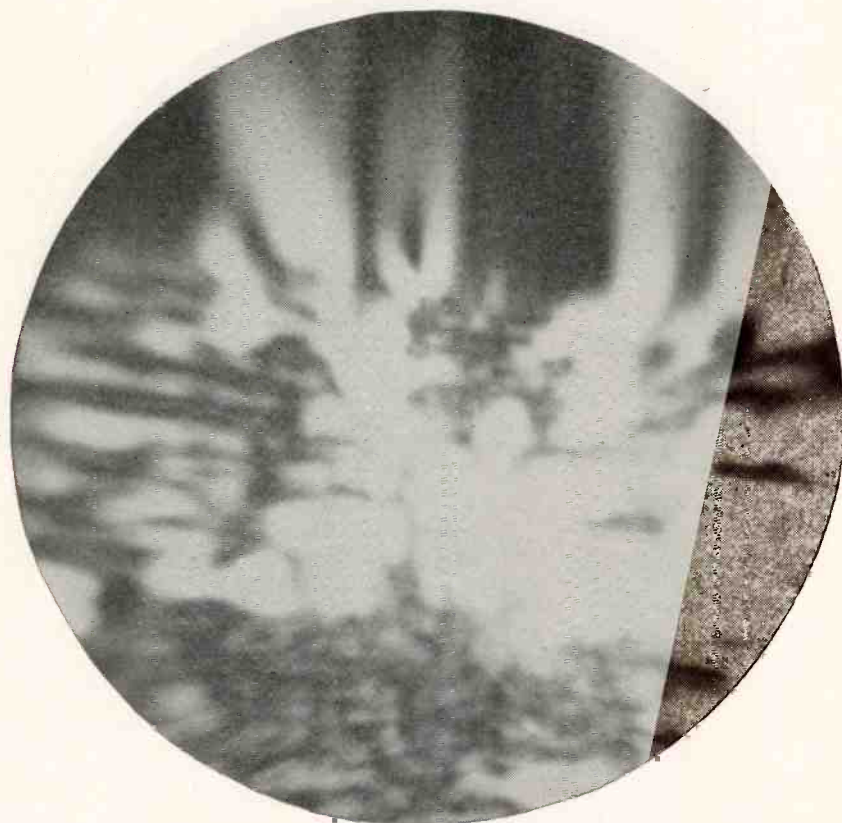

FIG. 6—Emission photograph of tantalum contaminated by thorium, taken at 1400 deg C. The edge of the sample was photographed so emission streamers may be seen

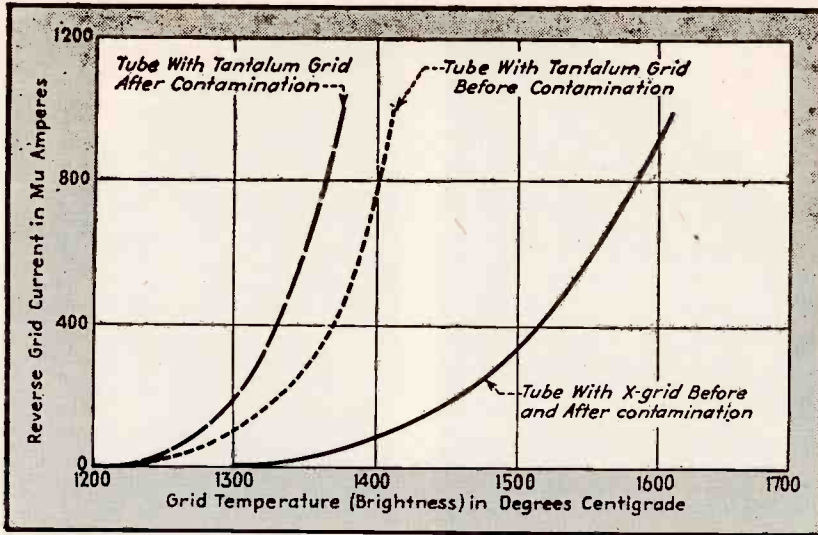

FIG. 7—Primary emission grid characteristics

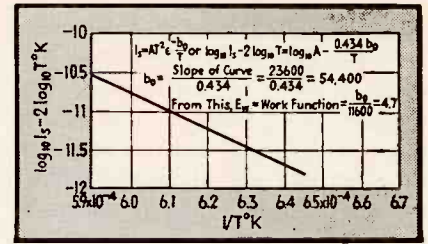

FIG. 9—Emission from a tantalum grid

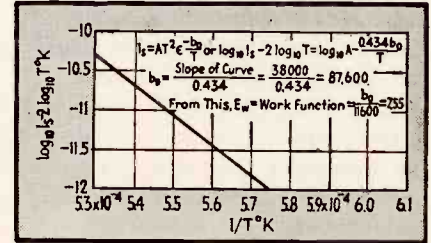

FIG. 10—Primary emission from an X grid

a higher work-function. Such is the case. Figure 9 is a plot of primary emission from tantalum, from which a work function of 4.7 is derived. This value compares favorably with that previously determined by others. A similar plot

is illustrated in Fig. 10 for the X-grid material, from which a work function of 7.55 is derived.

**Test Results**

It is now interesting to observe what happens when the X-grid is

contaminated with thorium. Figures 11 (a) and 11 (b) show emission patterns of the surface of X-grid material so contaminated, taken at 1700 deg C and 1900 deg C, respectively. These evidence a negligible increase in primary emission as compared with the pronounced increase exhibited in the case of contaminated tantalum. The ability of the X-grid to render thorium inactive is responsible for this improvement.

The solid-line curve in Fig. 7 shows that contamination of an X-grid in a tube does not increase its primary emission properties. By comparison with the dashed-line curve it will be observed that if 500  $\mu$ a is taken as a safe value of primary emission, a tantalum grid must be operated at a grid temperature under 1350 deg C whereas an X-grid may be operated in excess of 1500 deg C. A more striking difference will be noted at a grid temperature of 1350 deg C, where the tube with the X-grid has a reverse grid current of nearly zero, while that with a contaminated tantalum grid exhibits a reverse grid-current of about 600  $\mu$ a at the same temperature.

The secondary emission properties of the X-grid, compared to platinum for example, are illustrated by curves in Fig. 12, these curves being taken on two tubes having identical geometry. The

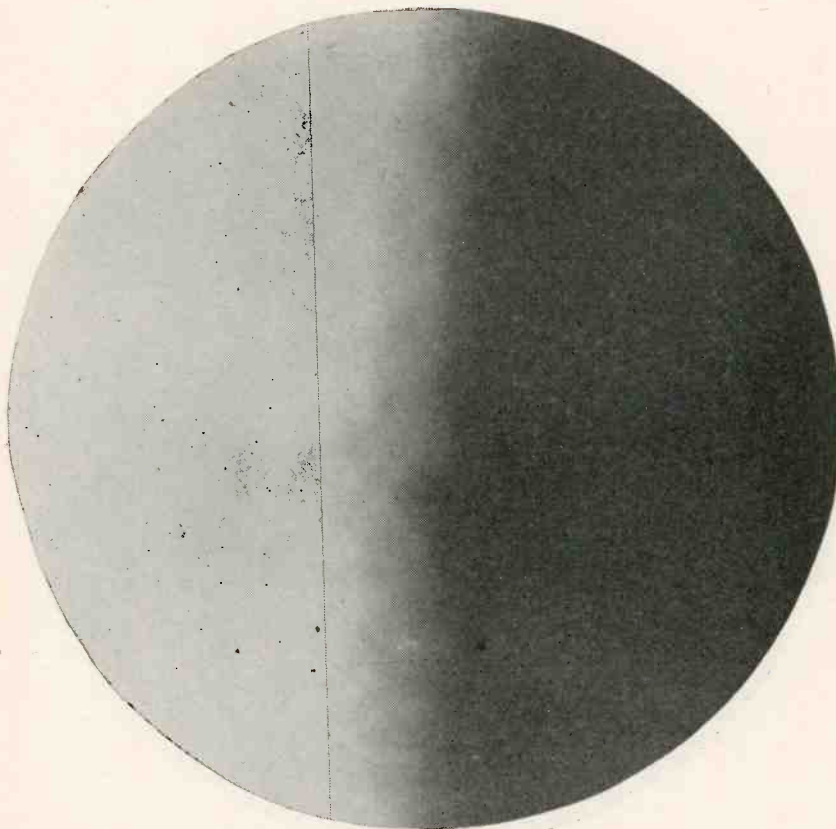

FIG. 8—Emission photograph of tantalum partially treated by X-process, taken at 1700 deg C. The left side shows the greater emission from the untreated portion, while the right side shows the reduced emission from the treated portion

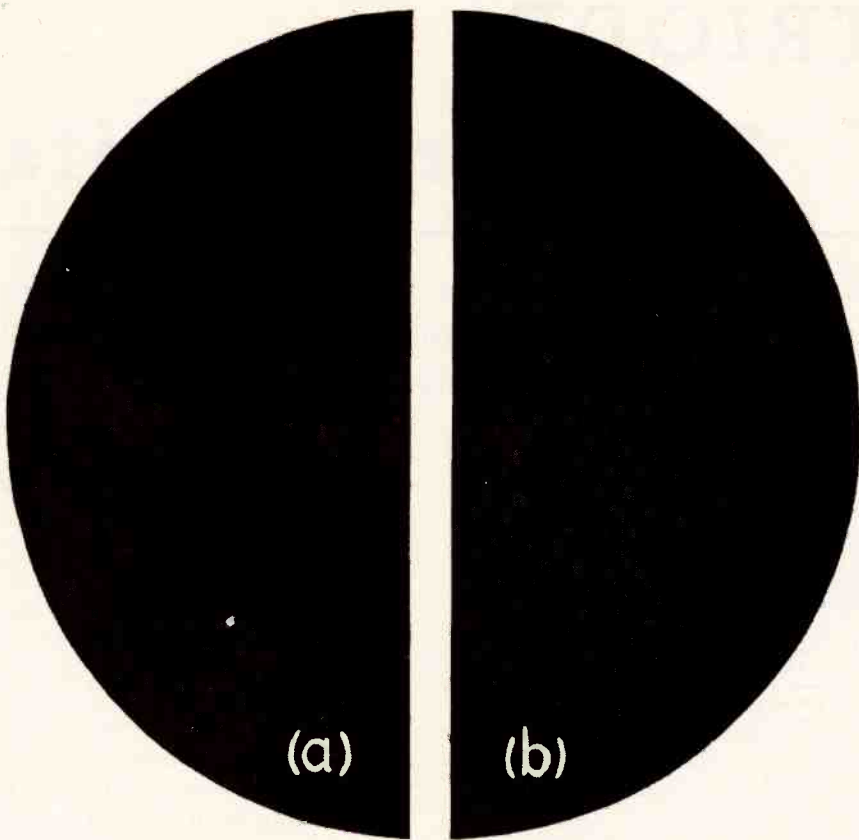

FIG. 11—(a) Emission photograph of X-processed material contaminated with thorium, taken at 1700 deg C, and (b) at 1900 deg C

higher order of secondary emission for platinum is indicated by lower values of grid current, which, for certain values of grid voltage in

the tube used, actually become negative. Secondary emission shows up in constant-current charts as loops in the grid current lines. Figure 13

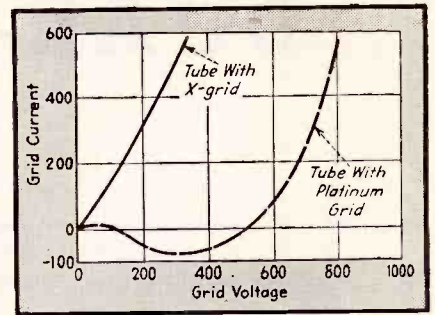

FIG. 12—Secondary emission characteristics, both tubes under test having identical geometry and operating with 2500 volts on their plates

is a chart of a tube having a platinum grid. This can be compared with the chart in Fig. 14 on a tube of identical geometry, but having an X-grid, showing the absence of such loops in the grid-current lines.

It is apparent that operation along a load line passing through the region of negative values of grid current would give a distorted wave of grid current, sufficient to cause instability and parasitic oscillations.

#### REFERENCES

- (1) Mourontseff, I. E., and Kozanowski, H. N., Grid Temperature as a Limiting Factor in Vacuum Tube Operation, *Proc. I. R. E.*, 24, p. 447, March, 1936.

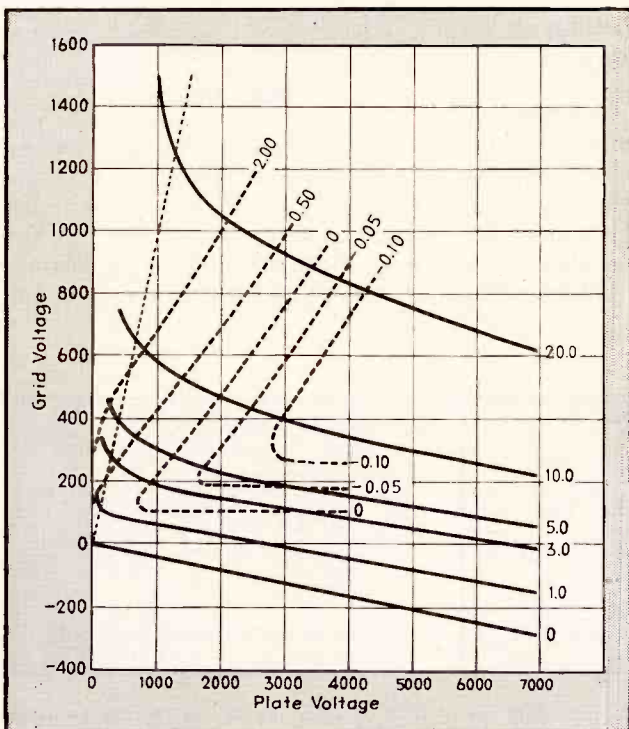

FIG. 13—Constant-current characteristics of a tube with a platinum grid. Solid-line curves represent plate current in amp; dashed-line curves represent grid current in amp

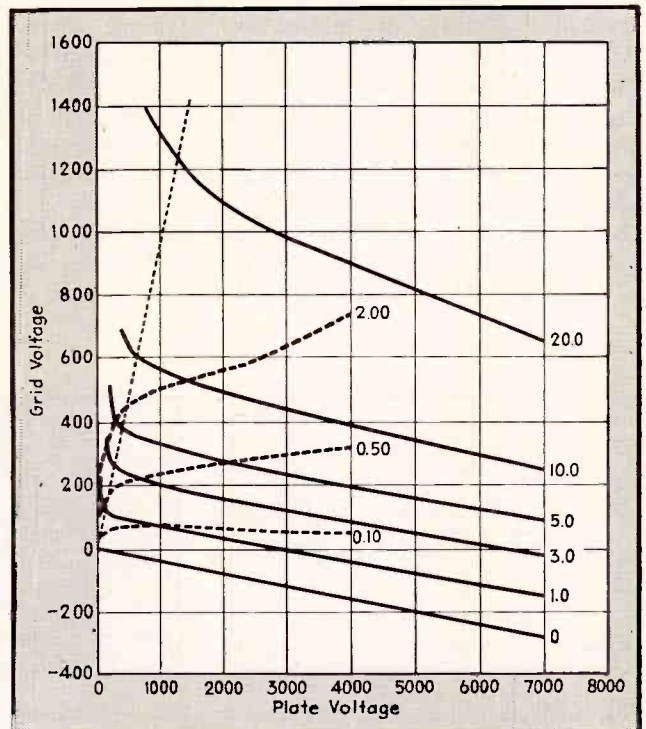

FIG. 14—Constant current characteristics of a tube with an X-grid. Solid-line curves represent plate current in amperes, while dashed-line curves represent grid current in amperes

# DUAL-TRIODE

## Trigger Circuits

Non-mathematical step-by-step description of the operation of the Eccles-Jordan trigger circuit, with practical suggestions for making the circuit distinguish between positive and negative pulses, and other helpful design data

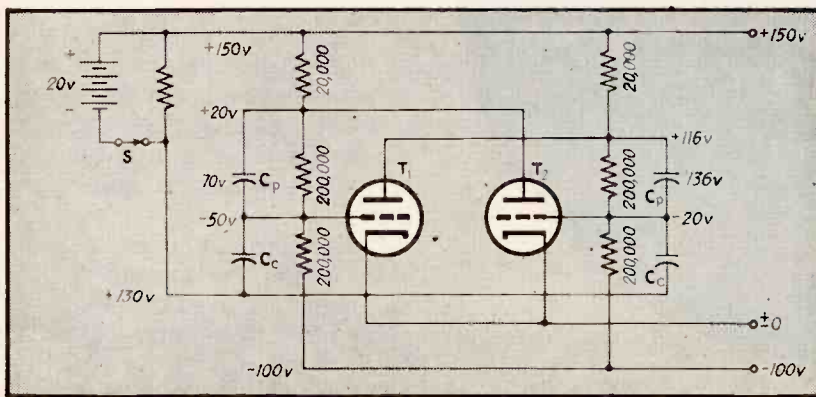

FIG. 1—The basic Eccles-Jordan trigger circuit

By **BYRON E. PHELPS**

*International Business Machines Corp.  
Endicott, N. Y.*

**T**HIS PAPER is an attempt to give a graphical analysis of dual-triode trigger operation. It is hoped that it will clear up several points that apparently have not been too well understood, in particular the very vital function of the grid-to-plate capacitor ( $C_p$  in attached sketches) and the ability of the Eccles-Jordan type of triode

trigger circuit to distinguish between positive and negative pulses if properly designed.

The dual-triode trigger described here is a device using two triode tubes so interconnected that one tube is normally conducting while the other is non-conducting. A suitable impulse applied at the proper points causes the first tube

to become non-conducting and the other to conduct. A second impulse restores the original condition. This cycle may be repeated at will at any speed from zero up to speeds in the low radio-frequency range or even higher, depending on the circuit constants used.

The trigger may be used as a locking circuit, somewhat as a gaseous tube is used. Where it is so used, the circuit may be turned off as fast as it can be turned on, and very little energy is required to make it perform either function. Since two impulses are required to provide a complete trigger cycle, i.e., to turn any one tube on and then off, the trigger can also be arranged to give one output impulse for every two input impulses and thus act as a frequency divider.

### Basic Principle

Figure 1 shows the basic Eccles-Jordan trigger circuit. The two triodes  $T_1$  and  $T_2$  are so connected that the plate of each controls the grid of the other in such a manner that only one tube can conduct (on)

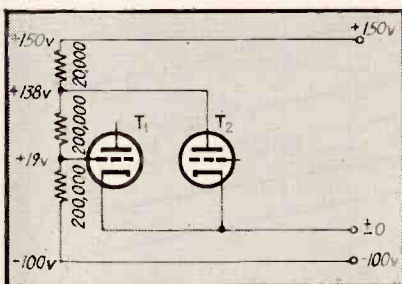

FIG. 2—Assuming that both tubes are initially non-conducting, application of voltage to the resistor network makes the grid of  $T_1$  positive with respect to its cathode and this tube conducts

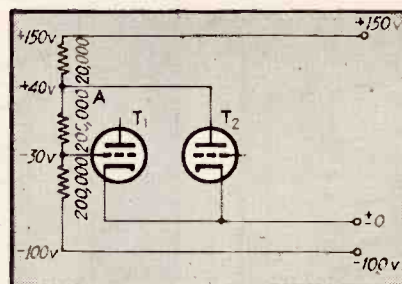

FIG. 3—When tube  $T_2$  is conducting, tube  $T_1$  is negatively biased and does not conduct. The plate of tube  $T_2$  drops to +40 volts and point A is held at that potential during this part of the operating cycle

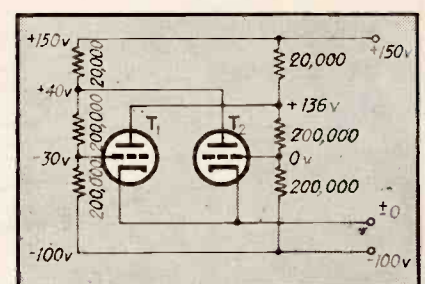

FIG. 4—The use of two resistor networks enables tube  $T_1$  to control tube  $T_2$  in a manner similar the way in which  $T_2$  controls  $T_1$  in Fig. 3. Voltages shown here are those applying when  $T_2$  is conducting



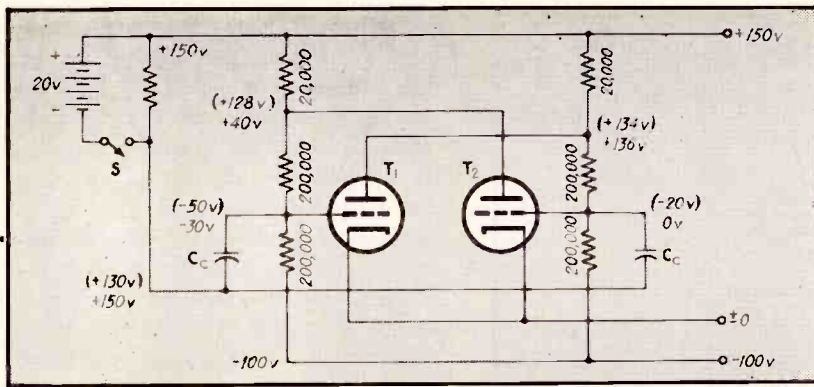

FIG. 5—Coupling capacitors  $C_c$  provide a means of temporarily biasing both grids together. This circuit is, however, incapable of reversing on the application of an impulse to both grids. Voltages indicated without parentheses are those applying with  $T_2$  conducting but with switch  $S$  open. Voltages in parentheses are those applying at the instant switch  $S$  is closed

at a time. The component values shown are merely illustrative and are used to simplify the analysis. However, these values will make a satisfactory trigger for relatively slow-speed operation.

The tubes used are 6J5's or equivalent and may be considered essentially as switches. When the grid of a 6J5 is at the same potential as its cathode the tube is conducting, just like a closed switch except that there is in the circuit illustrated a 40-volt drop between plate and cathode. When the grid is made negative with respect to its cathode by 8 volts or more, the tube is non-conducting and resembles an open switch in that no current can flow between plate and cathode.

Figure 2 shows more clearly how tube  $T_1$  can control tube  $T_2$ . With both tubes arbitrarily rendered non-conducting, the voltage at the grid of  $T_2$  is determined by the resistor network shown between the +150-volt line and the -100-volt line. By Kirchhoff's law, the grid of  $T_2$  may be calculated to be 19-

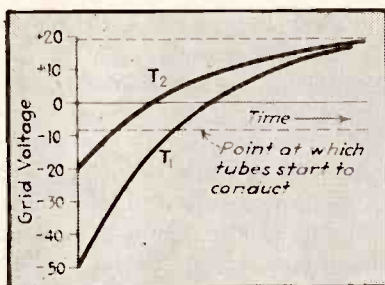

FIG. 6—Calculated grid-voltage rise after switch  $S$  of Fig. 5 is closed. Obviously, the grid of tube  $T_2$  will be the first to reach the -8-volt line, so that  $T_2$  turns on first when an initiating pulse arrives

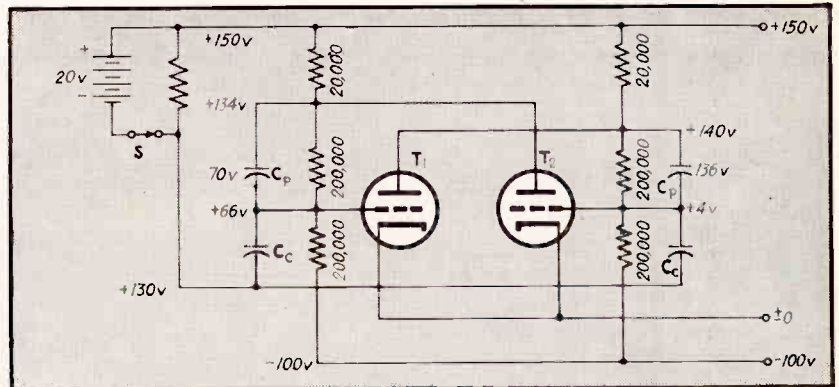

FIG. 7—Addition of capacitors  $C_p$  as shown here to the circuit of Fig. 5 makes possible the desired reversing trigger action. Voltages are those applying with  $T_2$  conducting

volts positive with respect to its cathode, thus turning  $T_1$  on. (Actually, sufficient grid current will normally flow in  $T_1$  to hold its grid down to approximately cathode potential).

When tube  $T_1$  is made conducting as shown in Fig. 3, its plate will drop to +40 volts and point  $A$  will be held at that potential. Again applying Kirchhoff's law, we find that the grid of  $T_2$  is now 30-volts negative with respect to its cathode and that  $T_2$  is thus held non-conducting by  $T_1$ . Connecting the grid of  $T_2$  to the plate of  $T_1$  with a similar network as shown in Fig. 4, will enable  $T_1$  to control  $T_2$  in the same manner, and we have the desired condition in which only one tube can be on at a time.

#### Circuit Details

Figure 5 shows a means of temporarily biasing-off both grids together through coupling capacitors  $C_c$ . Although this circuit has sometimes been shown as the basic Eccles-Jordan trigger circuit, it is fundamentally incapable of reversing on application of an impulse to

both grids. The voltage values shown without parentheses are those existing with  $T_1$  conducting and switch  $S$  open. Those in parentheses are the instantaneous values obtained when switch  $S$  is closed, delivering a 20-volt negative impulse to the grids through capacitors  $C_c$ . This 20-volt negative impulse will render both tubes non-conducting. Both grids will immediately start to rise to the resistance-network-limited value of +19 volts, the rate of rise being determined by the time constant of the resistor network and the  $C_c$  combination. Since these are the same for each tube, the time constant will be the same for both grids.

The rise of voltage on both grids will be as shown in Fig. 6. Obviously the grid of  $T_1$  will be the first to reach the -8-volt line, which means that  $T_1$  will be turned on first and will hold  $T_2$  off as before. In other words, the trigger has not been reversed. Likewise, a positive pulse will not reverse the trigger since any effect it might have on the non-conducting tube will be

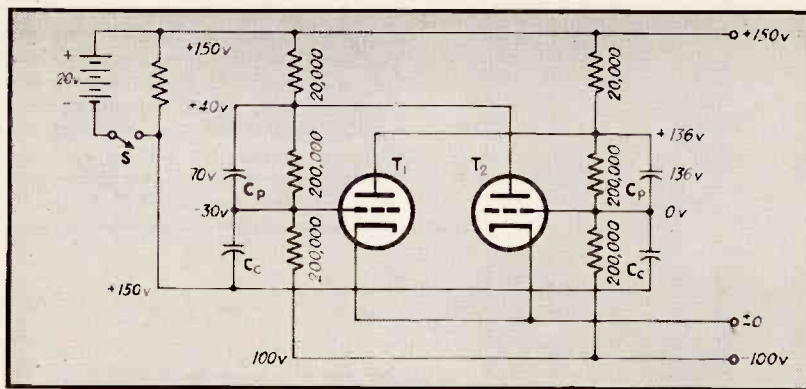

FIG. 8—A 20-volt negative impulse applied to the circuit of Fig. 7 by closing switch S, as shown here, drops instantaneous resistor-network potentials 20 volts

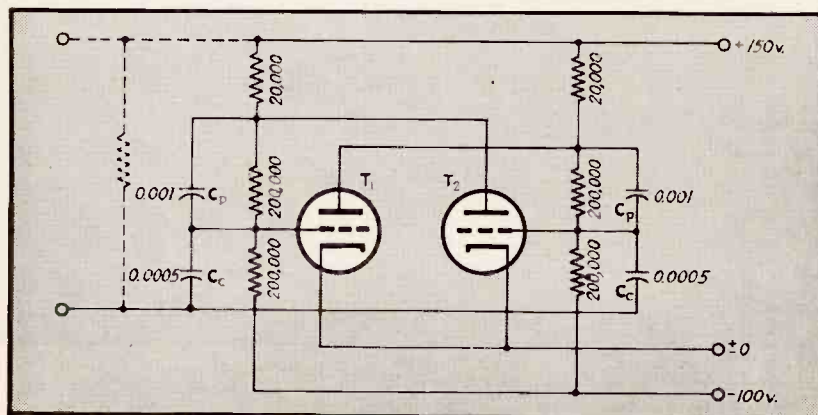

FIG. 9—If both tubes are held non-conducting by some external means, voltages shown in Fig. 8 will rise to these values soon after switch S is closed

offset by a stronger effect on the conducting tube.

It is the addition of the plate-to-grid capacitors  $C_p$  that makes possible the desired reversing trigger action. Figure 7 shows the addition of such capacitors to Fig. 5 and the steady-state voltages that exist with  $T_1$  conducting. A 20-volt negative impulse provided by closing switch S will instantly drop all network voltages by 20 volts, as shown in Fig. 8. For simplification, assume that plate-to-grid capacitors  $C_p$  are so large in comparison to coupling capacitors  $C_c$  that there will be no change of voltage across them in the time required for the smaller coupling-capacitors to reach a steady-state condition. Assuming that the tubes are held non-conducting by some external means, the voltages in Fig. 8 will soon change to those in Fig. 9, with the coupling capacitors  $C_c$  in equilibrium. The rise of voltage of the grids will be as shown in Fig. 10.

While these curves might be accurately calculated, they were actu-

ally obtained by plotting an  $s^{-1}$  curve between the known limits of grid voltage. Because of the much greater voltage-swing on  $T_1$ , caused by the relatively low voltage existing on the grid-to-plate coupling capacitor  $C_p$  between it and the plate of  $T_1$ , we see that the grid of  $T_1$  (which has been non-conducting) is the first to reach the conducting point of  $-8$  volts. Thus  $T_1$  becomes conducting and blocks off  $T_2$ , and the trigger is reversed. The addition of the plate-to-grid capacitors  $C_p$  has produced the desired trigger action and the trigger will now reverse itself every time the grids are given a negative impulse.

In drawing Fig. 10, it was assumed that the grid-to-plate capacitors  $C_p$  were much larger than the grid capacitors  $C_c$ . That this assumption does not alter the general shape of the curves of grid voltage rise is best shown in Fig. 11, which is a sketch of the grid-voltage rise in an actual trigger circuit (as shown in Fig. 1 with  $C_p = 2 C_c$ ) as viewed on a large cathode-ray oscilloscope.

Originally tube  $T_1$  is conducting and  $T_2$  is held non-conducting by the  $-30$ -volt potential on its grid (voltage as shown in Fig. 7). At time  $T$ , a 20-volt negative impulse is applied to both grids through the coupling capacitors  $C_c$ . Due to internal impedance of the square-wave generator used in this instance, the negative impulse as it appears at the grids is not quite square and at the grids the peak negative dip is  $-15$  volts. As soon as the maximum negative potential is reached, both grids start to rise in potential. As in Fig. 10, the grid of  $T_1$  rises much faster than the grid of  $T_2$  and reaches the conducting point first. When  $T_1$  starts to conduct, its plate goes down, forcing the grid of  $T_2$  way down and holding  $T_2$  non-conducting. After an interval of less than  $0.0001$  sec., the charges on all capacitors have been equalized and the circuit is as before, except that  $T_2$  is now conducting instead of  $T_1$ . The dotted lines indicate what the rise of the grid voltages might look like if the tubes could be held non-conducting by some external means.

Figure 12 shows both grid and plate-voltage changes for tube  $T_1$  when the trigger (circuit as in Fig. 1) is triggered or reversed continually by a 3000-cycle square-wave input. (The grid-voltage curve is the same as those in Fig. 11.)

#### Positive and Negative Impulses

So far nothing has been said about the ability of this trigger circuit to distinguish between positive and negative impulses.

If a square-wave input is of a low enough frequency, the positive rise of the square wave will appear to the trigger grids as a positive impulse of a magnitude equal to the negative impulse produced by the negative shift of the square-wave signal. To act as a frequency divider, the trigger must respond only to the negative shift. This it will do if the impulse is kept within reasonable limits. For example, a 20-volt negative impulse will cut off the conducting tube, enabling the trigger to transfer; a 20-volt positive impulse will not bring the grid of the non-conducting tube up to the conducting

point and thus cannot make the tube start to conduct. Its only action on the conducting tube is to drive the grid slightly positive. Therefore, the trigger will transfer only on a negative impulse or voltage shift and the trigger will act as a frequency divider on a 20-volt square-wave input.

The trigger circuit as shown will respond to negative pulses only, as long as they remain between the limits of 10 to 40 volts. Figure 12 shows why the trigger is not reversed on a positive pulse which is theoretically large enough to bring the grid of the non-conducting tube up to the conducting point. Notice that a point *B* the grid of the non-conducting tube actually appears to go negative although the square-wave input is shifting positively. This is because the positive impulse acting on the grid of the conducting tube drives its plate down almost 20 volts (point *C*). Through the plate-to-grid capacitor *C*, this dip of the plate of the conducting tube over-rides the positive impulse on the grid of the non-conducting tube, producing a negative dip as shown at *B*. (Although point *C*, as shown for tube *T*, is 180 deg. out of phase with point *B*, the corresponding point on the plate of *T*, if it were shown on Fig. 12, would be in phase with point *B*.)

For a positive impulse to turn on the non-conducting tube, it must be large enough to overcome the initial bias plus the negative swing produced at the non-conducting tube's grid by the voltage dip of the conducting tube's plate. The dip in the conducting tube's plate voltage is in this case caused by the same positive impulse acting on its own grid. The input limits depend on the impedance of the input circuit. The figures of 10-40 volts were obtained with a battery serving as a very low impedance source. With a 20,000-ohm output impedance of the square-wave generator, the input may be varied from 10 to over 70 volts at 3000 cycles.

#### Coupling Several Triggers

All that is required to use a trigger circuit of the type described as a frequency divider is to hold the input signal to reasonable limits (25 volts  $\pm$  15 volts for a

low-impedance source). No extra tubes or pulse selectors are required.

To couple two triggers together, it is only necessary to tap one plate resistor of the first trigger at one-quarter to one-half its value, coupling to the input capacitors of the second trigger as shown in Fig. 13. Tapping the plate-load resistor at one-quarter to one-half its value serves to furnish a portion of the output of the first trigger within the required limits for operation of the second trigger. Thus we have a simple straightforward trigger circuit which is capable of distinguishing between positive and negative pulses without additional tubes. Such triggers when properly designed are stable, dependable, and independent of any reasonable voltage-supply variation ( $\pm$ 20 percent variation in either bias or plate supply, more if both vary together).

As many triggers as desired may be coupled together by the methods outlined above to obtain any desired frequency reduction, the frequency being reduced by a factor of two for each trigger used. Such a frequency divider may be used in many ways, in combination with a mechanical counter for counting high-speed pulses far above the speed of the mechanical counter alone, in high-speed calculating, etc. A combination of a trigger and a power tube, where the trigger controls the power tube, may be used in place of a thyatron with the advantage that it may be turned off as easily as it is turned on. The triggers alone or in combination may also be used as electronic storage devices, since they are perfectly stable in either position.

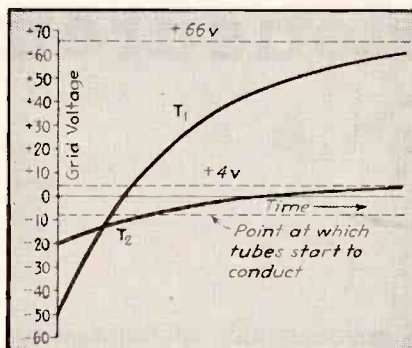

FIG. 10—Calculated grid-voltage rise as circuit voltages change from those shown in Fig. 8 to those shown in Fig. 9

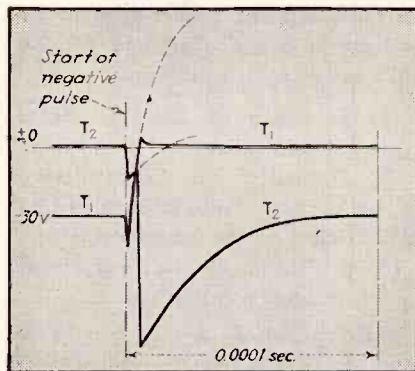

FIG. 11—Actual grid-voltage rise in the circuit of Fig. 1, as viewed on a cathode-ray oscilloscope

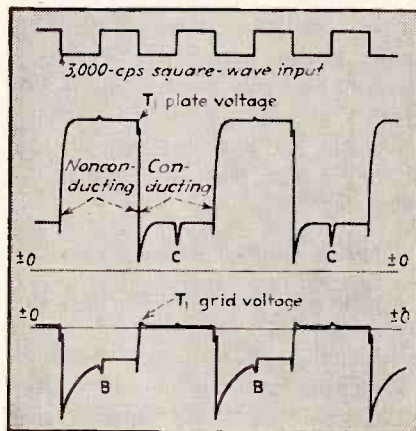

FIG. 12—Overall trigger circuit operation, as sketched from a cathode-ray oscilloscope

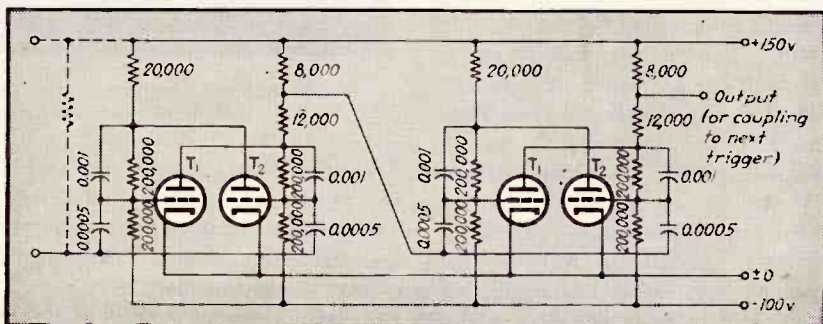

FIG. 13—Method of coupling two or more dual-triode trigger circuits

# Measurement of STRESSES in

**M**EASUREMENT of alternating stresses in rapidly moving mechanical parts has long been desirable for vibration analysis and fatigue-strength calculations. This has been difficult to accomplish by mechanical means because of the following major problems:

- (1) Presence of inertia effects in mechanical linkages.
- (2) Difficulty of transmitting the indications from a rotating or moving part to the observer.
- (3) Difficulty in calibration of the indicating mechanism.

These problems are all easier to solve when electrical or electronic methods of measurement are employed. There are a number of such methods by which stress can be measured. Of these, the method which utilizes resistance-wire strain gages has been developed farthest and has been used in the widest variety of rotating-shaft applications. For this reason, the present paper will be confined to this method.

## Resistance-Wire Strain Gages

It has long been known that the resistance of granulated carbon can be changed by pressure. Following this lead, carbon strips have been used as strain gages, but while the resistance of such strips changes markedly with stress, the behavior of carbon-strip gages is quite erratic.

The same effect exists in metals, although to a lesser degree than in carbon. When a metal wire is stretched, it becomes longer and thinner and its electrical resistance increases; the increase in resistance is usually somewhat larger than can be accounted for by the change in dimensions. Development of practical methods for utilizing this effect to measure stress and strain started about 1938, E. C. Simmons<sup>1</sup> and associates at California Institute of

Resistance-wire strain gages mounted on the shaft facilitate vibration analysis and fatigue-strength calculations. Methods of measuring both steady and alternating stresses caused by thrust, bending and torque are discussed. Tests on the propeller shafts of naval vessels are used as examples

By **W. F. CURTIS**

*David Taylor Model Basin  
Navy Department  
Washington, D. C.*

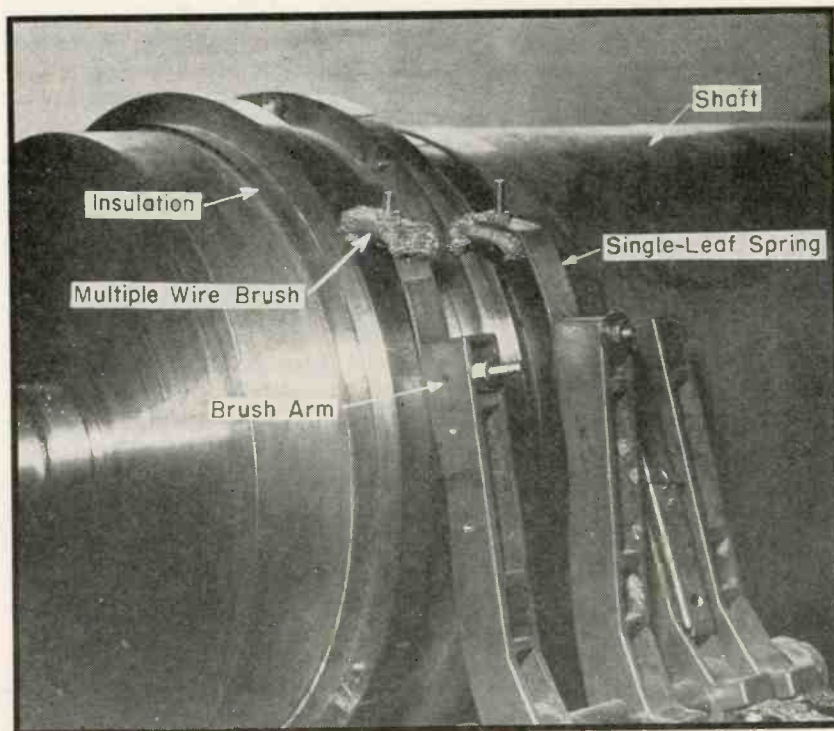

Slip-ring test stand, showing ring and brush construction recently adopted for measurement of stresses where the end of the shaft is not accessible

Technology and Ruge<sup>2</sup> and DeForest at Massachusetts Institute of Technology carrying out the work independently and apparently almost simultaneously.

Strain gages employing this principle were soon made commercially available by the Baldwin-

Southwark division of the Baldwin Locomotive Works. These gages have been used extensively for vibration measurements and strength testing. Dohrenwend's paper<sup>3</sup> is typical of much of such work.

The active element in these

# ROTATING SHAFTS

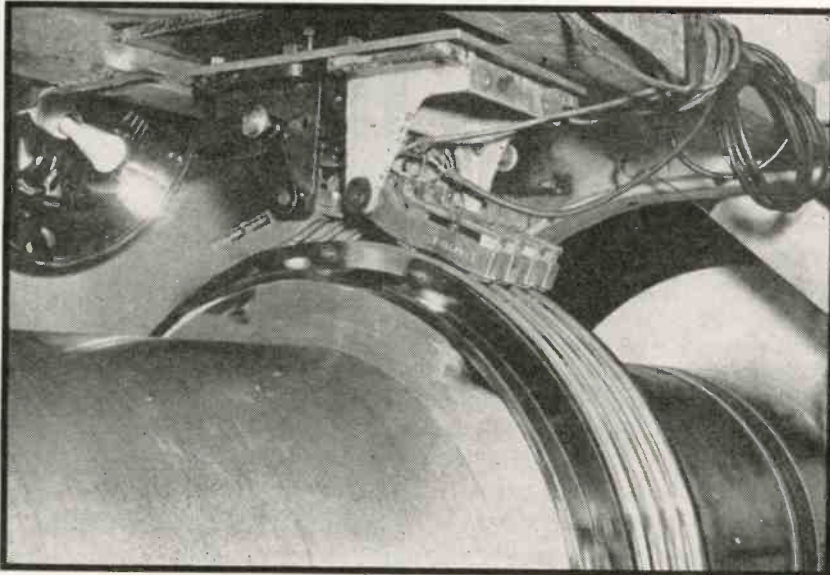

Early slip-ring installation on the propeller shaft of a naval vessel. Four carbon brushes were used on each ring

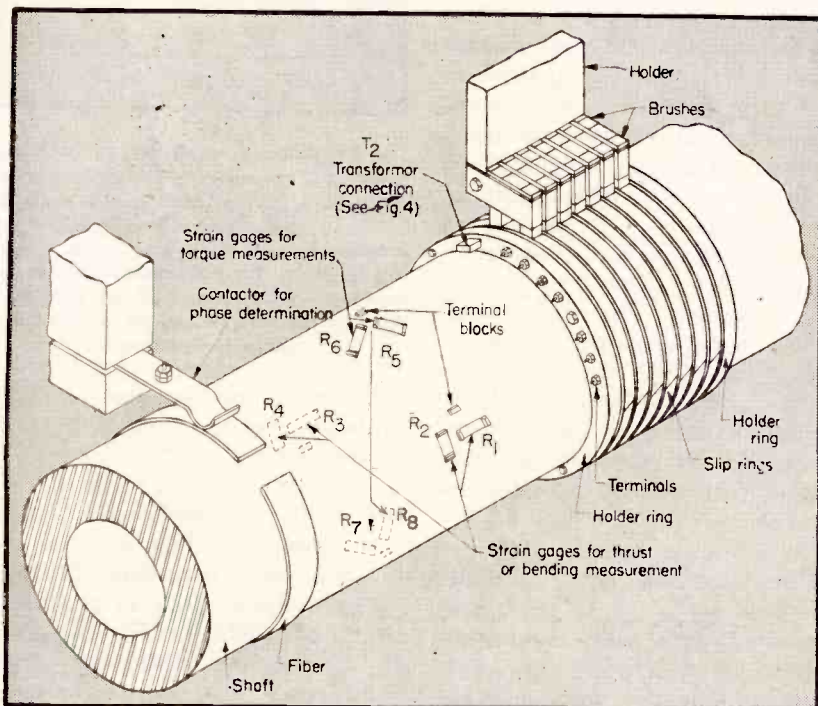

FIG. 1—Schematic of measuring apparatus mounted on a shaft

gages is a metal wire about 0.001 inch in diameter, laid in multiple-W form and conveniently mounted on paper for cementing to the part under test. The diameter of the wire must be of this order of magnitude to assure adequate bonding to the test piece. An essential

property of the gage is that it undergoes a change in resistance proportional to the strain in the wire and hence to the strain in the member under test, or

$$\Delta R/R = k\Delta l/l$$

This equation is valid for both

tension and compression if the wire is adequately bonded to the test piece so as to prevent buckling. Exact values of  $k$  are supplied by the manufacturer for each lot of gages;  $k \cong 2$  for gages of Advance wire having a low temperature coefficient and generally used for measurement of steady strains. For gages of isoelastic wire,  $k \cong 3.5$ ; these gages have a higher temperature coefficient than the Advance wire gages but are very satisfactory for measuring alternating strains.

## Locating Gages on Shaft

Figure 1 shows the location of gages on a shaft for measuring the three principal stresses: thrust, bending, and torque. It will be noted that from two to four gages are used in each circuit. The chief purpose of this multiplicity of gages is to discriminate among the different types of stress, but the arrangement also results in a reduction in temperature errors, a reduction in the electrical disturbances caused by the sliding brushes, and an increase in sensitivity.

Gages  $R_1$  and  $R_2$  are mounted with their strain-sensitive axes parallel to the axis of the shaft; the axes of gages  $R_3$  and  $R_4$  are perpendicular to the shaft axis. If the shaft is subjected to an axial compression, such as the propeller thrust produces in the propeller shaft of a ship steaming ahead, gage  $R_1$  is subjected to a compressive strain and gage  $R_2$  is subjected to a compressive strain of equal magnitude. Because of the Poisson effect, gages  $R_3$  and  $R_4$  experience a tensile strain a third to a fourth as great as the compressive strain in gages  $R_1$  and  $R_2$ .

Any rotating shaft will be subjected to an alternating bending stress, due to its own weight, and to other bending stresses due to any misalignment and unbalance which may exist. These forces are usually small in themselves, but

their effect on the shaft may be magnified by resonance effects to a degree which endangers the shaft or its bearings. If at any instant gage  $R_1$  is subjected to a compressive stress due to bending, gage  $R_4$  is also subjected to a compression and gages  $R_2$  and  $R_3$  are subjected to a tension. Furthermore, the magnitude of the compressive stress in  $R_1$  is equal to the magnitude of the tensile stress in  $R_3$ , and  $R_2$  and  $R_4$  are similarly affected.

If a shaft is subjected to torsion, the principal strains in the surface are directed at an angle of 45 degrees to the shaft axis, the strains being compressive for one set of 45-degree lines and tensile for the set which is at right angles to the direction of the compressive stress. Thrust and bending forces produce no strains along these 45-degree lines. Gages can be readily located along these lines by using a paper template wrapped around the shaft.

These facts can be used to devise circuits in which resistance changes due to the desired type of stress have an additive effect on

the output and changes due to the undesired type balance out. Cancellation of the undesired effect is complete if the orientation of the gages is exact and if  $R_1 = R_3$  and  $R_2 = R_4$ . The circuits of Fig. 2 and 3 are arranged to accomplish this cancellation.

#### Choice of Circuit

Several types of measuring circuits are available. The choice of circuit depends, first of all, on the frequency characteristics of the stresses being investigated. Wherever steady stresses are to be measured, a bridge type of circuit is indicated. For measuring steady stresses only, on land installations, a d-c bridge supply is used and a sensitive galvanometer is employed as an indicator. Such galvanometers are useless on shipboard, so that some other method must be used if shipboard experiments or the measurement of vibratory quantities is contemplated.

A d-c bridge-supply could conceivably be used with d-c amplification, but the use of a-c bridge-supply and carrier-current methods is much to be preferred. Some additional complications are introduced by the use of carrier, notably those due to the necessity of maintaining the bridge in reactive as well as resistive balance, but these complications are outweighed by the fact that the carrier-current amplifier is superior to the d-c amplifier in reliability, freedom from hum, gain, stability and simplicity. Carrier-current methods are well adapted to simultaneous measurement of both steady and alternating stresses.

If alternating stresses only are to be measured, the circuits of Fig. 3 are indicated. This makes it possible to dispense with the carrier-current source (usually a 5-watt electronic oscillator) and the bridge control equipment. In addition, the inconvenience of maintaining the balance of a bridge is avoided, and the potentiometer supply-battery can often be mounted on the shaft, thus minimizing much of the difficulties experienced with brush contacts.

Obtaining stress records by photographing the screens of

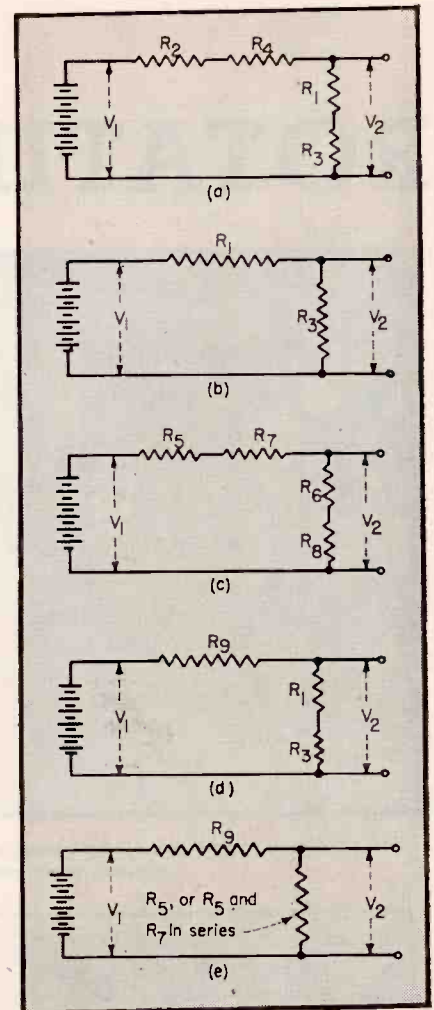

FIG. 3—Basic potentiometer circuits for measuring alternating stresses only. Resistors  $R_1$  to  $R_8$  are strain gages, while  $R_9$  is a fixed resistor generally mounted on the rotating shaft but not shown in Fig. 1. Circuit (a) is for thrust measurements, (b) for bending, (c) for torque, (d) for simplified thrust measurements, and (e) for simplified torque measurements

cathode-ray oscilloscopes in the ordinary way is possible but not very satisfactory. The stresses are subject to random variations in time which confuse a record taken with repeating sweep and are apt to cause misconceptions if single sweep is used. Due to the short length of record, harmonic content is difficult to determine from cathode-ray pictures; furthermore many vibration investigations require taking four to 12 simultaneous records. This can be done conveniently with a magnetic oscillograph but not so conveniently with cathode-ray oscilloscopes.

#### Choice of Recording Instrument

Several commercially available oscillographs are supplied with

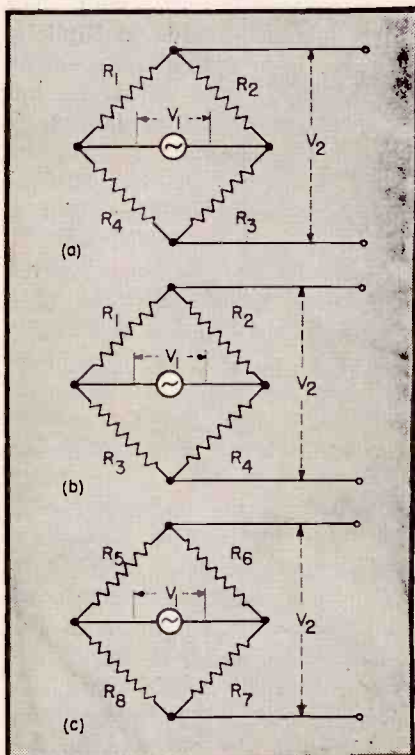

FIG. 2—Basic bridge circuits for measuring steady and alternating stresses. Resistors are the strain gages shown in Fig. 1. The arrangement at (a) is used for thrust measurements, that shown at (b) is employed for bending measurements, and (c) is for torque measurements

galvanometers that have an undamped natural frequency of about 2000 cps and will therefore reliably record frequencies up to 600 or 700 cps, which is ample for unrectified carrier recording and more than ample for rectified carrier or direct recording of vibration stresses in machine parts. These galvanometers require about 5 ma per inch deflection and hence can be driven direct-coupled from low-power receiving tubes such as the 6J5. A further increase in sensitivity would offer little advantage and would involve a galvanometer sensitive to mechanical shock and inferior in frequency range.

#### Unrectified Carrier Method

The unrectified carrier method of measurement is the simplest method by which both steady and alternating stresses can be measured. Gages are mounted in accordance with Fig. 1 and connected in accordance with Fig. 2. The choice of carrier frequency is dictated by a typical engineering compromise. A high carrier frequency permits the measurement of higher-frequency stress oscillations but requires a somewhat more critical reactance balance. Carrier frequencies in the neighborhood of 400 cps have been found satisfactory for most shipboard applications, although frequencies as high as 1500 cps have been used.

The principal circuit arrangements are shown in Fig. 4. All long connections are made with shielded microphone cable; by following this practice it has been found possible to locate the measuring instruments as much as 200 feet from the shaft without deleterious effects. This fact is often useful on shipboard, where instrument locations near the propelling machinery are often undesirable for one reason or another. Transformer  $T_1$ , shown as located on the shaft, can be located at the amplifier input without great loss in signal-to-noise ratio. Capacitors  $C_1$  and  $C_2$  are used for balancing out stray capacitances.

In practice, switches  $S_1$  and  $S_2$ , and resistor  $R_3$ , are adjusted so that a value of decade shunt resistor  $S$  between 20,000 and 50,000 ohms will balance the bridge when the

shaft is idle. Adjustment of the bridge to balance when the shaft is idle—that is, stressed as little as possible—is known as the zero balance adjustment.

Suppose the bridge is adjusted to zero balance and the shaft then subjected to its normal load. If, as is normally the case, the stress being measured has a steady component and an alternating component whose peak value is less than the steady component, the bridge output will be a modulated sine wave whose percentage modulation is less than 100. The distance between the upper and lower envelopes at any point of an oscillogram of this modulated wave is proportional to the instantaneous stress in the shaft.

Figure 5 is a sample oscillogram taken by the unrectified carrier method. Changing the setting of shunt  $S$  (Fig. 4) will change the amplitude of the unmodulated portion of the bridge output by a constant amount. So far as the bridge output is concerned, this is equivalent to adding or subtracting a constant stress, the magnitude of the addition being calculable by formulas presented later in this paper. If the alternating component of stress is a small fraction of the steady component, this feature can be used to increase the portion of the record taken up by the alternations. If the alternating component of the stress is greater than the steady component, this feature can be used to prevent overmodulation. The bridge must

always be adjusted so that the bridge output never falls to zero, otherwise the interpretation of the oscillogram is uncertain.

Figure 6 shows the circuit of an amplifier suitable for both the unrectified and rectified-carrier methods of measurement.

#### Rectified Carrier Method

Two advantages result from rectifying the bridge output before applying it to the oscillograph; the oscillograph is not required to record such high frequencies, and the resulting oscillogram is easier to read.

Simple diode rectification of the output is easily accomplished but is not too satisfactory. The bridge must in any case be adjusted so that its output is not overmodulated and yet the steady component of carrier frequency must not be large enough to saturate the amplifier. The presence of an unsuitable amount of carrier is not very obvious on the oscillograph when the carrier is simply rectified.

It is much better to use a bridge-detector circuit which registers the direction as well as the amplitude of the bridge unbalance. Many balanced detectors are phase-sensitive. A particularly simple and successful circuit is the one given in Fig. 7, which is similar in some respects to the circuit of the cosine galvanometer manufactured by the Hickock Instrument Company.

In practice,  $R_1$  is adjusted so that the output milliammeter reads zero

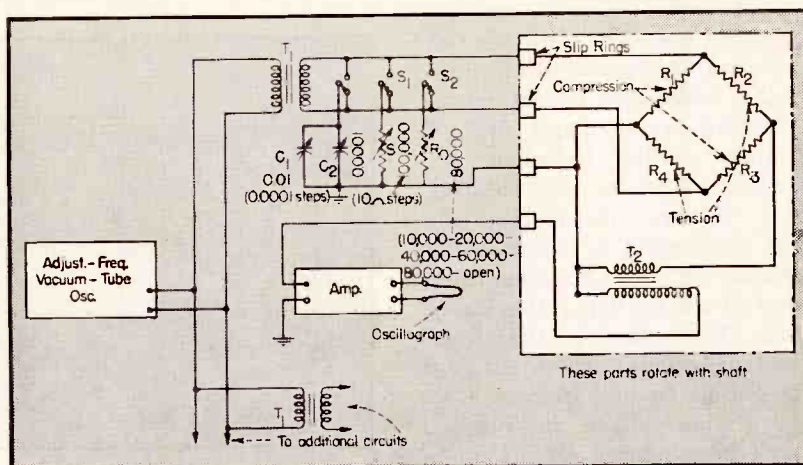

FIG. 4—Circuit used for unrectified carrier method of measurement.  $T_1$  is an isolating transformer which also matches bridge input impedance to oscillator output impedance.  $T_2$  is a step-up transformer bridge output to single grid, chosen for low 60-cycle hum pickup





constancy of contact resistance and low-amplitude brush hash. At the low current levels used, the contact does not show the nearly constant drop-of-potential characteristic of motor and generator brushes. The brush has a fairly definite average contact resistance. As the disturbing factor is the total resistance change rather than the percentage change in contact resistance, low average contact resistance is a desirable feature. In general, brush hash is likely to be tolerable if the materials of brush and ring are not too dissimilar. It will be seen that the requirements for a good brush for this application are quite different from the requirements for a motor or generator brush in conventional applications.

It is obvious that any tendency for the brush to leave the ring even momentarily produces intolerable interference; nevertheless the paramount importance of proper alignment of the rings was not appreciated for some time. In many cases, as for example when measuring stresses in the propeller shafts of ships, the ends of the shaft are not accessible so that it is necessary to make the rings in halves and clamp them around the shaft. It has been found that filling the crack between the ring halves with solder and dressing down with a file reduces brush interference by a large factor. Polishing the rings with a commutator-dressing stone while they are rotating has also proved helpful.

A number of different combinations of ring and brush material have been tried. Present practice is as follows: A standard connector unit comprising 12 silver rings with silver-graphite brushes has been constructed. The construction of this unit is shown in Fig. 10 and 11. This provides enough contacts for almost any test and is used whenever the end of the shaft being tested is accessible. For installation where the end of the shaft is not accessible, half-rings are formed from square brass stock and clamped around the shaft, as shown in a photograph appearing on the first page of this paper. A multiple-wire brush is now always used. The optimum brush-pressure is the least pressure which will hold the brush on the ring.

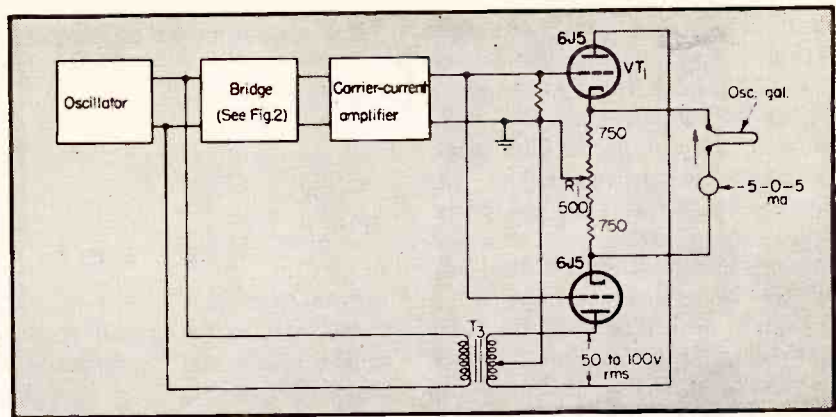

FIG. 7—Circuit used for the rectified-carrier method of measurement

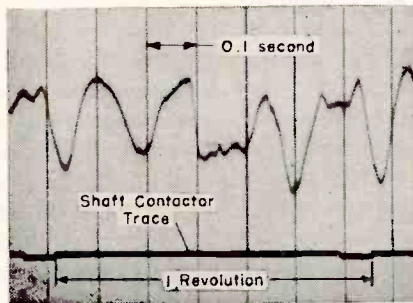

FIG. 8—Sample oscillogram obtained by the rectified-carrier method

#### Computation of Results

Let

- $A$  = cross-sectional area of shaft, sq. in.,
- $D$  = outside diameter of shaft, in.
- $d$  = inside diameter of shaft, in.
- $E$  = Young's modulus of shaft, lb. per sq. in.;
- $G$  = shear modulus of shaft, lb. per sq. in.;
- $N$  = Poisson's ratio of shaft
- $Q$  = torque applied to shaft, lb.-in.
- $T$  = axial thrust applied to shaft, lb.
- $M$  = bending moment at gage location, lb.-in.
- $S_v$  = shearing stress in shaft due to torque, lb. per sq. in.
- $S_r$  = axial stress in shaft due to thrust, lb. per sq. in.
- $S_b$  = fibre stress at gage location due to bending, lb. per sq. in.
- $R_1$  to  $R_8$  = unstressed resistances of gages of Fig. 1, ohms
- $R_3$  = resistance of ballast resistor, Fig. 4.
- $\delta$  = specific resistance variation of gage
- $v_1$  = instantaneous value of input to strain-gage bridge or potentiometer, volts ( $v_1$  is constant for potentiometer)
- $V_1$  = input to strain-gage bridge, rms volts
- $v_2$  = instantaneous value of output from bridge or potentiometer, volts
- $V_2$  = output from bridge or potentiometer, rms volts

When the shaft is subjected to an axial compression (thrust)  $T$ , gages  $R_1$  and  $R_3$  (Fig. 1) are subjected to a strain along their strain-sensitive axes of magnitude  $T/AE$ . As a compressive strain produces a decrease in resistance, the resulting specific change in resistance is

$$\delta_r = -kT/AE$$

Due to the Poisson's effect,

gages  $R_2$  and  $R_4$  are subjected to a strain of magnitude  $NT/AE$  in tension. This produces an increase in specific resistance

$$\delta_r' = NkT/AE = N\delta_r$$

Similarly, a bending moment  $M$ , if applied to the shaft in the proper orientation, produces a specific resistance change

$$\delta_b = \frac{k S_b}{E} = \frac{32 k M D}{\pi E (D^4 - d^4)}$$

in gage  $R_5$ , a specific resistance change of  $-N\delta_b$  in gage  $R_2$ , etc.

Torsion in the shaft subjects  $R_1$  to  $R_4$  to a shear strain only, and hence does not affect their resistances. Similarly, thrust and bending do not affect the resistances of gages  $R_5$  to  $R_8$ . Torsion produces a strain

$$\frac{\Delta l'}{l'} = \frac{S_v}{E} (1 + N)$$

in gages  $R_5$  and  $R_7$ , and a strain

$$\frac{\Delta l''}{l''} = -\frac{S_r}{E} (1 + N)$$

in gages  $R_3$  and  $R_8$ . As  $E = 2G(1 + N)$  and  $Q = (\pi/16) [(D^4 - d^4)/D] S_v$ , the corresponding specific resistance change is

$$\frac{\Delta l'''}{l'''} = -S_v (1 + N)$$

$$\delta_a = \frac{k \Delta l'''}{l'''} = \frac{8 k Q G D}{\pi (D^4 - d^4)}$$

The resistances of the gages under stress are then respectively

$$\begin{aligned} R_1 (1 + \delta_r - \delta_b) \\ R_2 (1 - N\delta_r - N\delta_b) \\ R_3 (1 + \delta_r + \delta_b) \\ R_4 (1 - N\delta_r + N\delta_b) \\ R_5 (1 + \delta_a) \\ R_6 (1 - \delta_a) \\ R_7 (1 + \delta_a) \\ R_8 (1 - \delta_a) \end{aligned}$$

where the  $\delta$ 's have all been defined in terms of the unknown forces or moments and shaft geometry.

It is now only necessary to determine the  $\delta$ 's in terms of the re-

sistor values used and the output voltages found during the experiments. This can readily be done by setting up the Kirchhoff law equations for the circuits of Fig. 2 and 3, using the resistances of the gages under stresses as just given. These computations are straightforward but rather lengthy and will not be reproduced here.

Taking advantage of the facts that (a) all the  $\delta$ 's are very much less than unity (of the order of 0.001 or less); (b) the shunt resistor  $S$  can be kept very much larger than any of the gage resistances; and that (c) the value of the auxiliary shunt resistor does not affect the result if it is kept constant during the tests, the results can be expressed by the following simple formulas:

If any one of the bridges shown in Fig. 2 is balanced when the shaft is substantially unstressed, and if when the shaft is subjected to a load the bridge output is  $V_2$ , then

For measurement of thrust

$$\delta_r = \frac{2}{1+N} \left( \frac{V_2}{V_1} \right)$$

$$S_r = \frac{2E}{(1+N)k} \left( \frac{V_2}{V_1} \right)$$

$$T = \frac{2AE}{(1+N)k} \left( \frac{V_2}{V_1} \right)$$

For measurement of bending

$$\delta_b = \frac{2}{1+N} \left( \frac{V_2}{V_1} \right)$$

$$S_b = \frac{2E}{(1+N)k} \left( \frac{V_2}{V_1} \right)$$

$$M = \frac{\pi E (D^4 - d^4)}{16(1+N)kD} \left( \frac{V_2}{V_1} \right)$$

For measurement of torque

$$\delta_q = \frac{V_2}{V_1}$$

$$S_r = \frac{2G}{k} \left( \frac{V_2}{V_1} \right)$$

$$Q = \frac{\pi G (D^4 - d^4)}{8kD} \left( \frac{V_2}{V_1} \right)$$

Note that  $V_1/V_2 = v_1/v_2$ . The phase-shift in the carrier produced by the bridge and amplifier reactances results only in a time delay which is constant for all frequencies of stress variation if the phase-distortion in the amplifier has been kept low, and is of negligibly small magnitude if the carrier frequency is larger than the frequencies of stress variation by a sufficiently large factor. For this reason, either instantaneous or rms voltage values can be used in the preceding set of equations, and also in the two sets of equations immediately following. These equations can be readily extended to cover cases where the bridge is not maintained at zero balance. If  $S_0$  is the value of the shunt resistor  $S$  which results in zero output when the shaft is not stressed, then the values of the typical specific resistance, stress, and force or moment of force which will result in zero output with some other value of shunt resistance  $S'$  are given. For measurement of thrust, the specific resistance change for obtaining balance with shunt  $S'$

$$\bar{\delta}_r = \frac{R_1 (S_0 - S')}{2(1+N)S_0 \delta_r'}$$

The stress for balance with shunt  $S'$

$$\bar{S}_r = \frac{E}{k} \bar{\delta}_r'$$

The thrust for balance with shunt  $S'$

$$\bar{T} = \frac{AE}{k} \bar{\delta}_r'$$

For measurement of bending

$$\bar{\delta}_b = \frac{R_1 (S_0 - S')}{2(1+N)S_0 \delta_b'}$$

$$\bar{S}_b = \frac{E}{k} \bar{\delta}_b'$$

$$\bar{M} = \frac{\pi E (D^4 - d^4)}{32kD} \bar{\delta}_b'$$

For measurement of torque

$$\bar{\delta}_q = \frac{R_1 (S_0 - S')}{4S_0 \delta_q'}$$

$$\bar{S}_r = \frac{2G}{k} \bar{\delta}_q'$$

$$\bar{Q} = \frac{\pi G (D^4 - d^4)}{8kD} \bar{\delta}_q'$$

The resistance of the auxiliary shunt  $R_1$  does not matter as long as it is the same for all values of  $S$ . Furthermore, if the bridge output is  $V_2$  when the shunt resistance is  $S'$ , then the total specific resistance changes  $\delta_r$ ,  $\delta_b$  and  $\delta_q$ , the total changes in stress  $S_r$ ,  $S_b$  and  $S$ , and the total changes in force or moment  $T$ ,  $M$  and  $Q$  are given by thrust

$$\delta_r = \bar{\delta}_r + \frac{2}{1+N} \left( \frac{V_2}{V_1} \right)$$

$$S_r = \bar{S}_r + \frac{2E}{(1+N)k} \left( \frac{V_2}{V_1} \right)$$

$$T = \bar{T} + \frac{2AE}{(1+N)k} \left( \frac{V_2}{V_1} \right)$$

bending

$$\delta_b = \bar{\delta}_b + \frac{2}{1+N} \left( \frac{V_2}{V_1} \right)$$

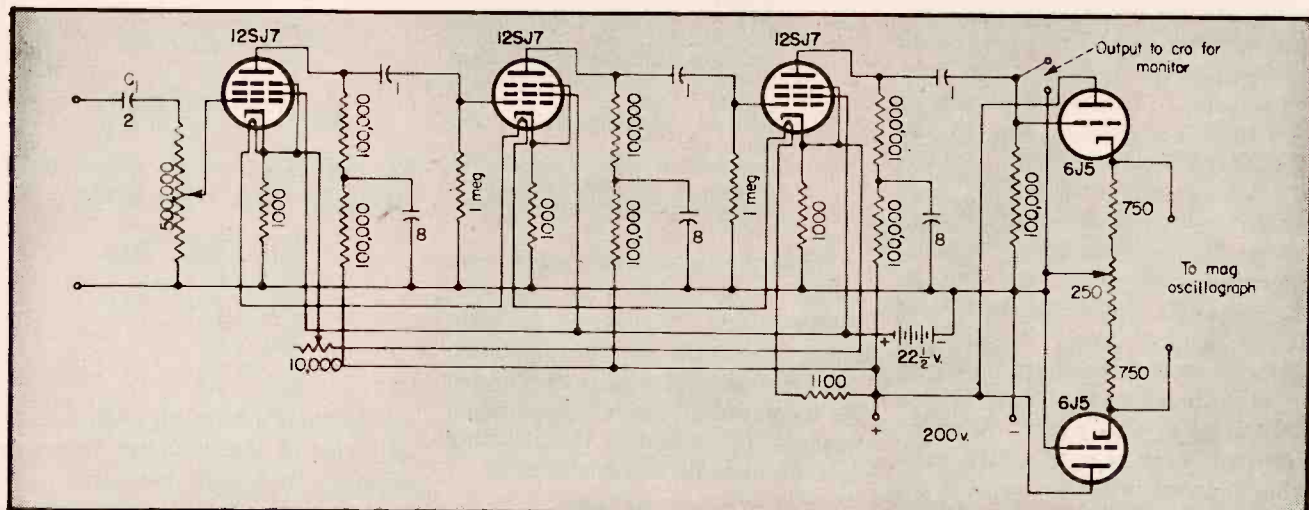

FIG. 9—Circuit of amplifier used for the direct method of measurement

$$S_B = \bar{S}_B + \frac{2E}{(1+N)k} \left( \frac{V_2}{V_1} \right)$$

$$M = \bar{M} + \frac{\pi E (D^4 - d^4)}{16(1+N)kD} \left( \frac{V_2}{V_1} \right)$$

torque

$$\delta_a = \bar{\delta}_a + \frac{V_2}{V_1}$$

$$S_r = \bar{S}_r + \frac{2G}{k} \left( \frac{V_2}{V_1} \right)$$

$$Q = \bar{Q} + \frac{\pi G (D^4 - d^4)}{8kD} \left( \frac{V_2}{V_1} \right)$$

The circuits given in Fig. 3 are always used with capacitance coupled amplifiers, so that the oscillograph indicates only the alternating component of output voltage. For this reason, it is best to express the results thus obtained in terms of departures from average values of resistance, stress, and force, rather than in terms of departure from the condition of no external load as was done for the bridge circuits. With this understanding, the formulas for interpreting the results of measurements by the direct method are as follows:

for circuit of Fig. 3(a)

$$\delta_r = \frac{4}{1+N} \left( \frac{V_2}{V_1} \right)$$

for circuit of Fig. 3(d)

$$\delta_r = \frac{(R_1 + R_3 + R_5)^2}{(R_1 + R_3) R_5} \left( \frac{V_2}{V_1} \right)$$

for circuit of Fig. 3(b)

$$\delta_B = 2 \frac{V_2}{V_1}$$

for circuit of Fig. 3(c)

$$\delta_a = 2 \frac{V_2}{V_1}$$

for circuit of Fig. 3(e)

$$\delta_a = \frac{(R_5 + R_7 + R_9)^2}{(R_5 + R_7) R_9} \left( \frac{V_2}{V_1} \right) \text{ or } \frac{(R_5 + R_9)^2}{R_5 R_9} \left( \frac{V_2}{V_1} \right)$$

#### Calibration of Equipment

In cases where the shaft studied may be stopped at will, the two carrier-current methods lend themselves to very simple and accurate calibration in terms of the shunt resistor  $S$ , which should be a precision decade resistance box.

Let  $y$  be the peak-to-peak carrier amplitude as measured on the oscillogram in an unrectified carrier system, or the deflection of the trace in an oscillogram taken by the rectified carrier system. If then  $y_1$  is the observed amplitude or deflection taken when the shunt

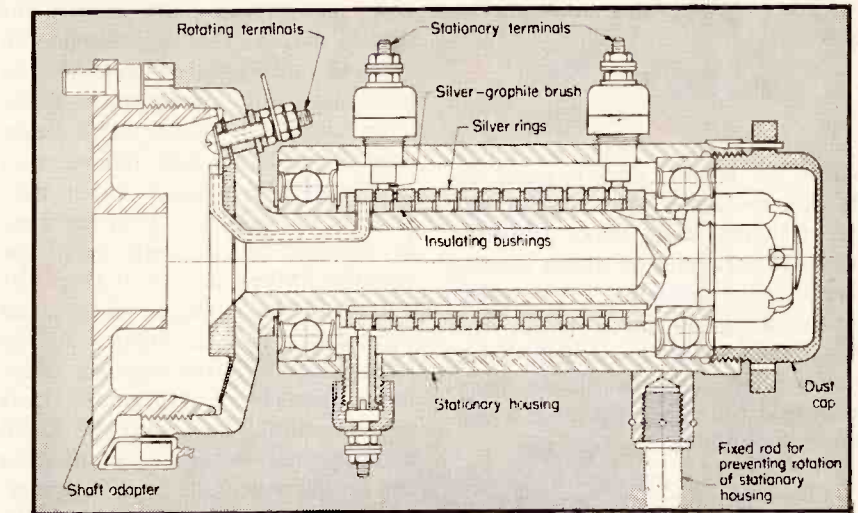

FIG. 10—Drawing of connector unit employed whenever the end of the shaft under test is accessible, an adaptation of a design furnished by the Hamilton-Standard Propeller Company. The unit is pictured in Fig. 11

resistance is  $S_1 < S_0$  and  $y_2$  is the observed amplitude or deflection taken when the shunt resistance is  $S_2 > S_0$  (where  $S_0$  is the shunt resistance for zero balance), then it can be shown from formulas already presented that

for circuit of Fig. 2(a)

$$T = \frac{A E}{2k(1+N)} \frac{R_1 (S_2 - S_1)}{S_1 S_2} \frac{y}{(y_1 + y_2)}$$

for circuit of Fig. 2(b)

$$M = \frac{\pi E (D^4 - d^4)}{64k(1+N)D} \frac{R_1 (S_2 - S_1)}{S_1 S_2} \frac{y}{(y_1 + y_2)}$$

for circuit of Fig. 2(c)

$$Q = \frac{\pi G (D^4 - d^4)}{32k(D)} \frac{R_5 (S_2 - S_1)}{S_1 S_2} \frac{y}{(y_1 + y_2)}$$

where  $y$  is the instantaneous deflection or amplitude on an oscillo-

graph for example the propeller shafts of ships, cannot be stopped at will. Calibrations of this type can be made with the shaft under load by using average values of  $y_1$  and  $y_2$ , but if the average stress varies in the interval between the recording of the first and second oscillograms, errors will be introduced.

Potentiometer-type strain-gage circuits can be calibrated by momentarily shunting the gages in one arm of the potentiometer with a known high resistance. As the associated recording equipment is not capable of registering d-c potentials, this results in a transient excursion of the oscillograph beam; the deflection corresponding to the resistance change can be estimated but is subject to some uncertainty. The experience of the author with this method of calibrating potentiometer-type gage circuits indicates that the accuracy is rather low. Change of shunt resistance, however, is the most accurate method of calibrating strain-gage bridges if the stresses in the shaft can be maintained constant during the calibration.

Alternatively, calibration can be accomplished by measuring the voltage sensitivity of the amplifier-oscillograph combination and the voltage supplied to the gage circuit. It must be remembered, however, that while the deflection of the oscillograph beam is proportional to instantaneous voltage, most a-c voltmeters and standard signal-generators are calibrated in rms volts.

The voltage sensitivity of the

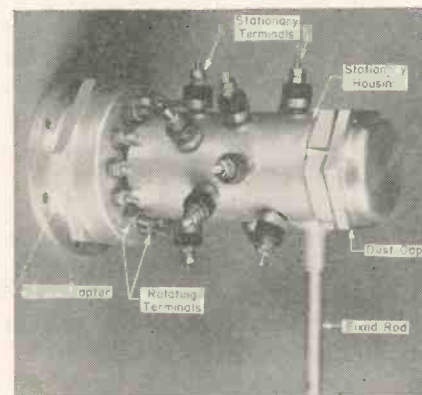

FIG. 11—The connector unit shown schematically in Fig. 10

gram taken with any desired load on the shaft, and  $T$ ,  $M$ ,  $Q$  are corresponding instantaneous values of thrust, bending moment, and torque respectively.

Unfortunately some shafts, as

amplifier-oscillograph combination is

$$K_o = \frac{2.828 V_o}{y_o}$$

(instantaneous) volts per inch where  $y_o$  is the peak-to-peak deflection produced by an input signal of  $V_o$  rms volts, when using the unrectified carrier or direct method and  $y_o$  is the deflection (from zero) produced by an input of  $V_o$  rms volts when using the rectified carrier method. Then for thrust measurements by either of the carrier-current methods

$$T = \bar{T} + \frac{2 AE}{(1+N)k} \frac{K_o y}{(2.828 V_o)}$$

$$= \bar{T} + \frac{2 AE}{(1+N)k} \frac{V_o}{V_1} \frac{y}{y_o}$$

where  $T$  is total instantaneous thrust,  $\bar{T}$  is the steady thrust for which the bridge is balanced,  $y$  is the distance between the upper and lower envelopes at any point of the oscillogram if unrectified carrier is used, and  $y$  is the distance from the zero line to the trace if rectified carrier is used.

For thrust measurements by the direct method, instantaneous values of the alternating component of thrust are given

for the circuit of Fig. 3(b)

$$T = \frac{4 AE}{(1+N)k} \frac{K_o y}{v_1} = \frac{11.31 AE V_o}{(1+N)k v_1} \frac{y}{y_o}$$

for the circuit of Fig. 3(c)

$$T = \frac{AE}{k} \frac{(R_1 + R_2 + R_3)^2 K_o y}{(R_1 + R_2) R_3 v_1}$$

Similar formulas for bending and torque measurements can be written readily enough.

#### Accuracy and Sensitivity

The accuracy of measurements made with resistance-wire strain-gages is affected by many factors in a complex way. No completely definitive analysis of the errors involved has yet been made so far as the author is aware. Nevertheless, the upper limit of the probable over-all error is quite definitely known and it can be confidently stated that the accuracy and sensitivity are sufficient for most engineering tests.

If four strain-gages are cemented to a nonrotating part and connected into a bridge-type network, it will be found that the zero balance of the bridge drifts rather erratically as time goes on, even under labor-

atory conditions. The reason for this is not entirely understood. In general, temperature effects are the principal source of errors in measuring steady stresses. The gage-wire itself has a low temperature coefficient of resistance, but in general the material to which the gage is cemented has a coefficient of expansion different from that of the wire, and the resulting differential expansion produces strains in the wire which in turn produce resistance changes. Furthermore, it is possible that there may be small changes in the gage constant  $k$  as the temperature changes. However, in laboratory experiments of the type just described, observed temperature changes did not correlate very well with the drift in zero balance.

Another source of difficulty is the leakage resistances associated with the bridge. This effect is especially severe when measurements must be made in a damp location such as the shaft alley of a ship. Radiant heaters have occasionally been installed in the hope of preventing condensation of moisture on the slip-ring insulators by raising the temperature slightly. The effect of leakage resistance increases with the square of the gage resistance; however, reducing the effective gage resistance by using two or three gages in parallel in each arm of the bridge did not appreciably improve the over-all accuracy.

Still another probable source of error is plastic flow in the cement used to secure the gages to the parts under test. The accuracy which has been obtained in tests, where it was possible to check the results of the gage measurements, indicate that the gage wire must follow the strains in the surface to which it is attached quite closely. However, the precise magnitude of effects of flexibility in the cement is still somewhat in doubt.

In some cases, it has been possible to check the values of the steady component of stress in shafts by means of independent measurements. In these cases, the stress values obtained from the strain-gage measurements were rarely in error by more than 100 pounds per square inch; this result agrees with early estimates

published by the Baldwin-Southwork Company. This error is quite tolerable if the stress being measured is at all high. In cases where temperature changes do not occur rapidly and zero balance can be checked frequently, it should be possible to improve this figure considerably.

It has not been possible to obtain such definite checks on the alternating components of stress in shafts. It is estimated that the accuracy of measurement is about 10 per cent in cases where severe temperature changes are involved, and three to five per cent under more favorable circumstances.

The sensitivity to stress changes depends on whether or not the change occurs rapidly enough to be distinguishable from the drift in zero balance. When the stress change occurs at a frequency of 2 cps or more, the sensitivity depends only upon the ability to distinguish stress changes from interfering stray potentials arising from the amplifier and particularly from the brush contacts. Such differentiation can often be made on the basis of wave-form or frequency.

Under good conditions, alternating stresses as low as 10 pounds per square inch have been detected. It will thus be seen that the sensitivity of the method is ample for engineering tests.

#### Acknowledgments

The author desires to express his indebtedness to the following members and former members of the David Taylor Model Basin staff:

Capt. A. G. Mumma, U.S.N., whose interest, cooperation and advice were invaluable in the early stages of the development; W. J. Sette, who shared responsibility for the development throughout the early stages; F. B. Bryant and V. E. Benjamin, who performed much of the experimental work; and L. E. Wedding, who also performed experimental work and was largely responsible for the slip-ring and brush design.

#### REFERENCES

- (1) Simmons, Edward E., U. S. Patents 2,292,549; 2,316,203; and others.
- (2) Ruge, Arthur C., U. S. Patents 2,316,975; 2,318,102; 2,322,819; and others.
- (3) Dohrenwend, C. O., Measurement of Dynamic Strain, *Jour. App. Mech.*, June, 1943.

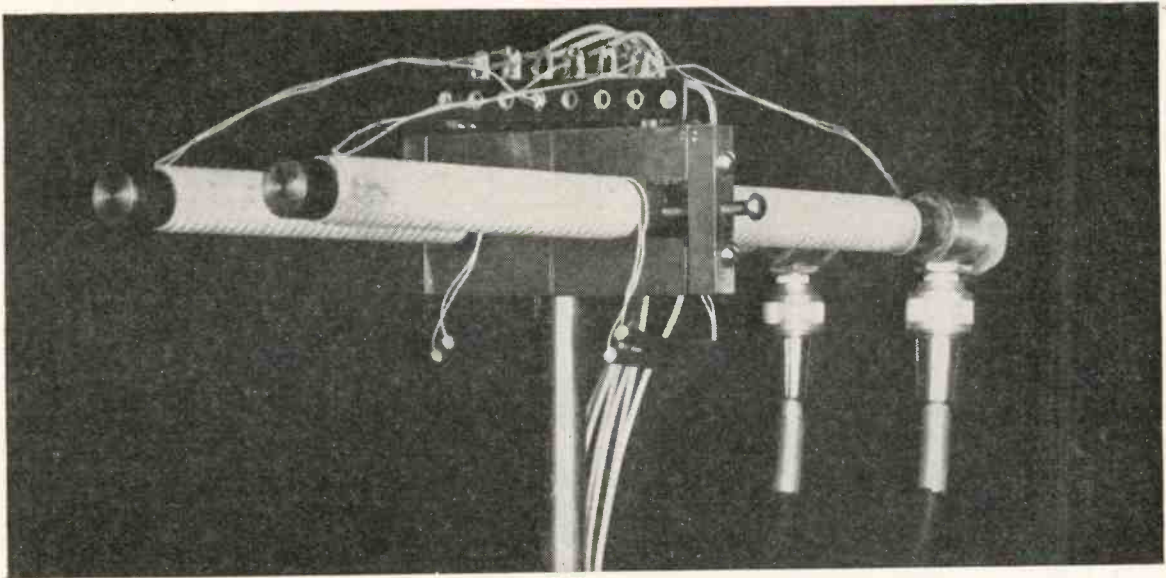

Experimental model of magnetostriction compass, employing a balanced two-rod arrangement. Systems employing a single rod are equally feasible

# MAGNETOSTRICTION COMPASS

Rods of magnetostrictive material are subjected to an a-c magnetic field, and rotation in the earth's field changes the amplitude of vibration sufficiently to actuate a crystal pickup feeding an electronic amplifier and zero-center direction-indicating meter

By **R. G. ROWE**  
Niagara Falls, New York

**W**HILE THE GYRO COMPASS and radio range systems have aided immeasurably in the art of aviation, the magnetic compass still persists as a tremendously useful and important device. All magnetic compasses, however, suffer several definite impediments to accurate operation, one of which is known as the acceleration error. For example, with a magnetic compass mounted in aircraft, for a right turn from a north course the compass will indicate that the pilot is turning left, due to the fact that during the banked turn the plane of the pendulously mounted compass card tilts from horizontal and rotates erroneously owing to the now-present vertical component of the

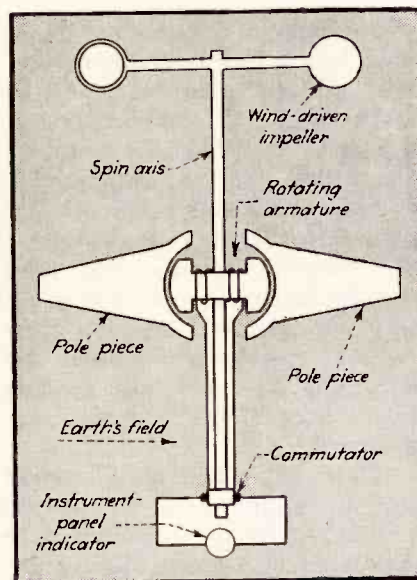

FIG. 1—Elementary magneto compass, in which the field for the rotating armature is provided by the magnetic field of the earth passing through the highly permeable pole pieces

earth's field. On a left turn the reverse action will take place, rendering this type of compass inaccurate as a turn indicator.

A further compass error is often introduced through the unfavorable magnetic location of the compass on the instrument panel of the aircraft, because of the proximity of the motor and the disturbing fields of wires carrying current to other instruments and controls.

## Magneto Compass

The magneto compass provided one of the first means for eliminating errors due to unfavorable magnetic location of the field-responsive device as well as substantially reducing errors due to acceleration. In Fig. 1 is an elementary sketch of the magneto compass, which consists of a coil rotating between the specially shaped

pole pieces consisting of two highly permeable rods. When the rod axes lie in an east-west direction no poles are induced and no voltage is generated by coil rotation. When the rod axes are in a north-south direction poles are induced and a voltage is generated. By pendulous or gyro stabilization of the rods, acceleration error may be reduced. The rod axes may tilt over a restricted range with respect to the armature spin axes without affecting compass operation. This field-responsive device may be installed in a variety of favorable magnetic locations, with appropriate leads to the indicating meter on the instrument panel.

In the magneto type of compass there are limits to the reduction of the acceleration error, partially due to the mechanical limits of the tilt between the rod axis and the armature spin axis. Further, this compass requires some sort of motor drive for the armature as well as commutation to rectify the developed voltage. It would be an advantage to eliminate the rotating armature and provide some other means for indicating flux density in the permeable rod. In recent years this has been accomplished effectively by using rods or thin sheets of a material which is partially or fully saturated by the earth's magnetic field. Electrical means are provided for indicating the state of saturation of the material according to its position in the earth's field, generally employing various modifications of a transformer with the easily saturable material as the core.

#### Magnetostriction Phenomenon

The experimental magnetic field-responsive device or compass described here, which may be called a magnetostriction compass, does not depend on core saturation for its operation. Instead, this compass employs the effect of weak fields, such as the earth's field, on the magnetostrictive action of various materials exposed to the observed field.

In general, magnetostriction refers to that set of phenomena in which certain materials exhibit a change in dimension upon magnetization. Figure 2 graphically illustrates the way in which various

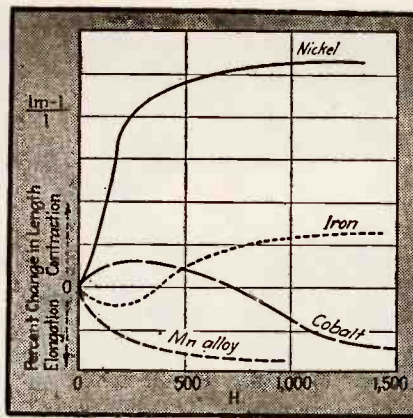

FIG. 2—Examples of magnetostriction curves for various materials, showing the percent change in length with intensity of a magnetic field  $H$

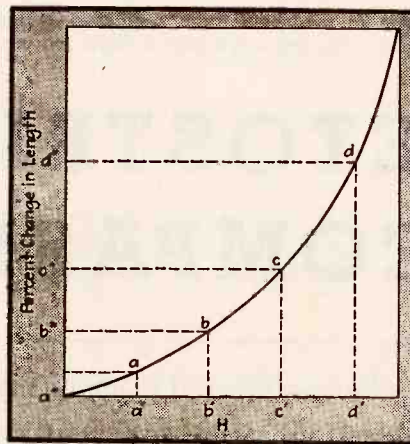

FIG. 3—Expanded magnetostriction curve, illustrating how shifting of the operating point causes changes in amplitude of vibrations produced by a superimposed a-c field

ferromagnetic substances change their length in a magnetic field.

If a rod of ferromagnetic or magnetostrictive material is suspended in the field of the earth, the length of the rod changes in accordance with its position in the field. The change in length attending magnetization by weak fields such as that of the earth is so exceedingly minute, however, that rugged mechanical means for indicating the dimensional changes would be difficult to design and construct.

When an alternating current field is impressed on a partially premagnetized rod in addition to the steady field under observation, however, variations in the intensity of the observed field will cause a remarkable change in the resonant amplitude of vibration of the rod. This action can be readily

explained with reference to the expanded magnetostriction curve in Fig. 3.

When the rod is so positioned that the earth's magnetic field places the operating point at  $b$  on the curve, an a-c field that swings  $H$  from  $a'$  to  $c'$  about operating point  $b$  will make the change in rod length vary between  $a''$  and  $c''$ . If the rod is then moved more nearly parallel to the earth's magnetic field so as to shift the operating point to  $c$  on the curve, the same a-c field will now cause a much greater change in rod length, from  $b''$  to  $d''$ .

When the frequency of the applied alternating magnetic field is closely matched to that of a natural elastic longitudinal period of the rod, resonance occurs between the electrical and mechanical systems and the amplitude of rod displacement becomes large enough to be detected electrically by conventional vibration pickups. Steady magnetic fields of low intensity, such as the earth's field of 0.15 to 0.30 gauss, are of sufficient magnitude to shift the operating point on the curve and produce variations in the amplitude of vibration of the rod.

#### Magnetostriction Compass

An experimental version of the magnetostriction compass is shown schematically in Fig. 4. Magnetostriction rods  $A$  and  $B$  are made of annealed steel and cut to identical dimensions so both will resonate at the same frequency. A close approximation of the fundamental longitudinal period of the rods may be determined by

$$f = \frac{1}{2l} \sqrt{\frac{E}{d}}$$

where  $f$  is frequency in cps,  $l$  is rod length in cm,  $E$  is the elastic modulus of the rod material in dynes per sq cm, and  $d$  is the density of the rod material in grams per cu cm. For a rod of annealed steel 25.4 cm long for which  $d$  is 7.8 and  $E$  is  $22 \times 10^{11}$ , the resonant frequency is approximately 10,000 cps.

Both of the rods in Fig. 4 are firmly clamped at their midpoints (nodes), permitting the assembly to be rotated in the horizontal component of the earth's field while the rods are retained parallel and in the same plane. To facilitate mount-

ing, the coils on each rod are split into two sections. The alternating-current winding is close-wound directly on each rod, with the pre-magnetizing winding space-wound directly over it. The a-c windings are excited from a convenient source of alternating current such as an audio signal generator. The battery, potentiometers, and pre-magnetizing windings cooperate to magnetize each rod oppositely and independently.

To detect the longitudinal rod vibration, a shielded piezoelectric rochelle salt crystal is affixed at the end of each rod. The remainder of the circuit is quite conventional, with two audio amplifiers to amplify the rod output signals, two tuned filter circuits to pass only the rod frequency, and a balanced metering circuit to indicate changes in amplifier output which are caused by changes in rod output.

#### Operation of Compass

Initially, rods A and B are positioned in an east-west direction and slightly but oppositely magnetized by the battery, potentiometers and pre-magnetizing windings. An alternating excitation voltage is then applied to the other windings by a variable-frequency generator, the frequency of which is tuned to the mechanically resonant fundamental longitudinal period of the rods. Rod resonance is easily observed by noting amplifier output. When the ap-

proximate fundamental period is first determined by calculation, slight frequency adjustment over the neighboring range will assure resonance between the electrical and mechanical systems. The gain of the amplifiers and the setting of the potentiometer in the metering circuit are now adjusted so that the center-zero meter shows no deflection.

Now when the rods are rotated, magnetic flux lines appear along the longitudinal axes of the rods due to the earth's magnetic field. If the polarity of this new field adds to the premagnetized condition of rod A, it will simultaneously buck the premagnetized condition of rod B, because the two rods are oppositely premagnetized. The vibrational amplitude of rod A will increase and that of rod B will decrease, unbalancing the balanced metering circuit and causing the meter to deflect to the right, for example. For opposite polarity of this new field, the meter will deflect in the opposite direction. When the longitudinal axes of rods A and B are parallel to the horizontal component of the earth's field, the zero-center meter will give a maximum deflection either to right or left, according to the field polarity.

#### Other Applications

Another promising circuit utilizes one premagnetized magnetostriction rod as a magneto-mechanical feedback link in a regenerative

system equipped with volume compression, where the plate current of the compressor tube indicates the direction or magnitude of the observed field. Other circuits measure the phase angle between the exciting and output voltages of the rod as modified by the external field.

An unmagnetized nickel rod becomes shorter when introduced into a magnetic field, the change in length depending on field intensity but not field polarity. In an alternating field the rod will be shortened twice for each complete cycle of the exciting voltage. A steady field may shift the operating point, varying the percentage of second harmonic component in the fundamental vibration, and this waveform distortion is easily detectable.

The discovery that magnetic fields of low intensity exert an electronically measurable influence upon mechanically resonant magnetostrictive systems, as well as the initial development of suitable electronic measuring means, points out the way for further development in the field of magnetics. To the physicist it provides an approach to plotting magnetostrictive curves at low field intensities. To the metallurgist it offers the possibility of developing magnetostrictive materials with particularly suitable and novel magnetic properties. To the electronic engineer it affords the basis for new concepts and improvements in instrumentation.

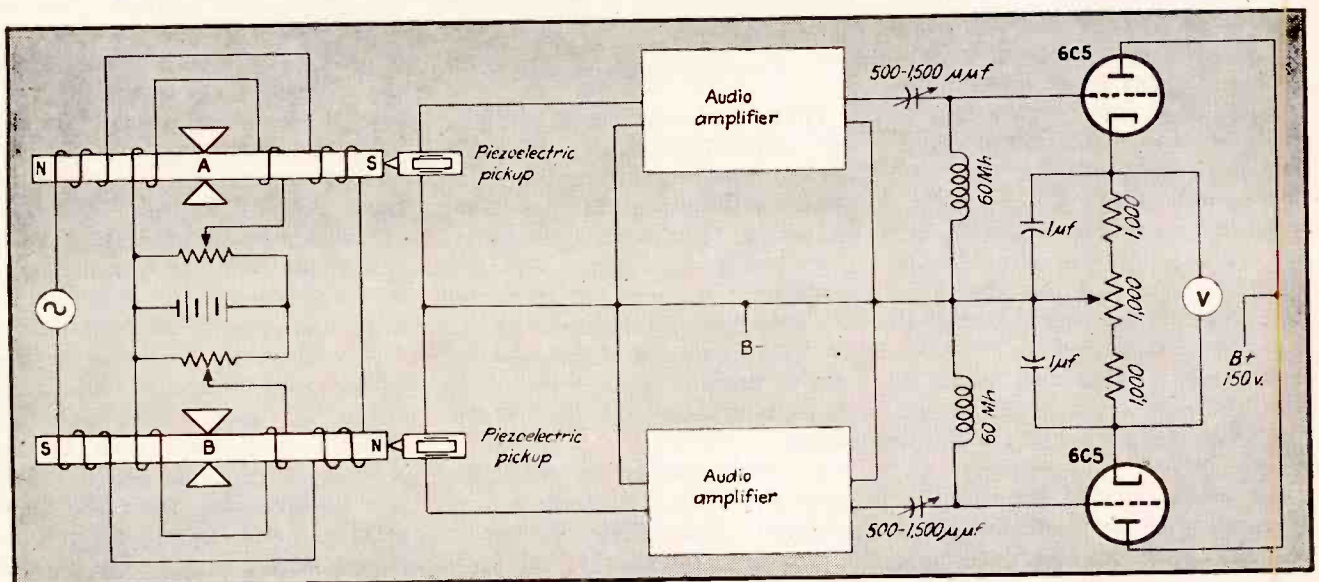
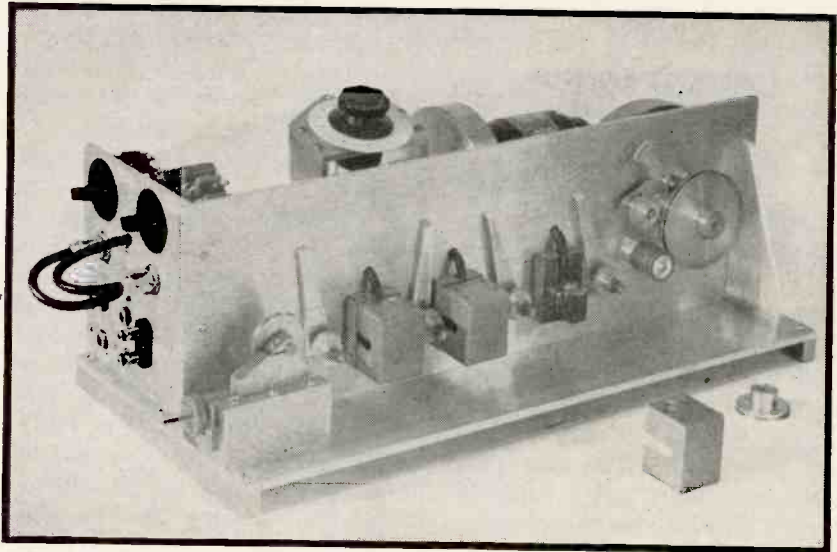

FIG. 4—One form of magnetostriction compass circuit, employing two vibrating rods in a balanced arrangement, with zero-center voltmeter V calibrated to indicate direction

# Supersonic Bias for

Front view of loop tester, showing the shielded recording, erasing, and reproducing heads. To the extreme right is the driving capstan. The calibrated dial for speed control is above and to the back; this dial reads wire speed in fps



By  
**LYNN C. HOLMES**  
and  
**DONALD L. CLARK**

*Research Department  
Stromberg-Carlson Company  
Rochester, N. Y.*

Research indicates the optimum value of a supersonic bias field for improving linearity of magnetic transfer characteristics and reducing magnetic noise level. Measurements indicate the effects of recording-reproducing head design and wire speed on frequency response

**R**ECENT DEVELOPMENTS in magnetic recording have created a new and widespread interest in this recording method. Using magnetic recording it is easily possible to produce records of any desired length. It is possible to record a complete symphony or, in the case of speech recordings, an entire book on a single length of wire without any splice. Another great advantage in the use of magnetic recording, as compared with recording on discs, is that the record material shows no appreciable wear.

When a record has served its usefulness, the wire recording can be erased by exposure to a supersonic field and the recording medium will then be in condition to receive a new record. This also makes it possible to correct errors in recording without destroying the entire record.

As the novelty of recording on magnetic wire wears off, those who are interested in recorded music from the viewpoint of the fidelity of the recording rather than the novelty of the method are going to

compare this newer method critically with some of the older methods. If magnetic recording is not equal to, or better than the older methods which are now used for the recording of music, it will soon lose favor with these critical listeners except for novel entertainment.

#### Recording Characteristics

There are four major performance characteristics to be considered in the study of any recording system. These are: (a) non-linear distortion; (b) frequency response; (c) signal-to-noise ratio; (d) wow or flutter. We have not attempted to name these in the order of importance. Any one of these factors may be the limiting one insofar as the enjoyment of the listener is concerned.

We shall consider magnetic recording in relation to the first three in detail. The effects of wow or flutter are well-known and it is sufficient for the purpose of this paper to point out that wows which are not even noticeable with speech

may be intolerable with music. In general, it is also true that all the requirements for good reproduction of music are much more severe than those for the intelligible reproduction of speech.

In any practical magnetic recording system, some method of biasing is necessary in order to place the operating range on a linear portion of the transfer characteristic. The most obvious method and the one used in early systems employed direct current in the recording head. Investigation of the effects of superimposed alternating fields and direct fields on ferromagnetic materials showed the possibility of using a supersonic field for bias.

Any magnetic recording system using direct-current bias will ordinarily leave the recording medium magnetized even in the absence of an audio signal. This is a disadvantage from the viewpoint of noise, as will become apparent later. On the other hand, the system using a supersonic bias leaves the recording medium practically demagnetized except when an



# Magnetic Recording

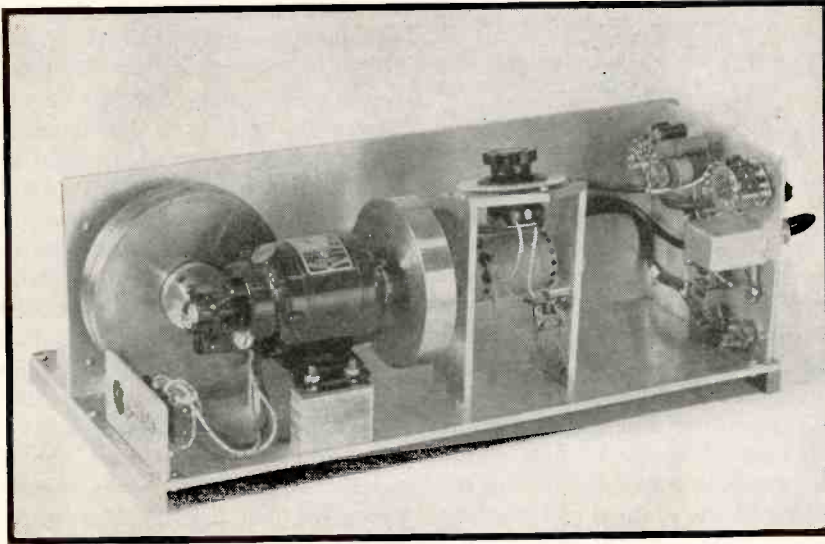

Back view of loop tester. Flywheels for reducing speed fluctuations are attached to the high and low-speed shafts of the driving motor. An alternator connected to the high-speed shaft actuates the electronic speed control

audio signal is being recorded. This is an inherent advantage and should result in a higher signal-to-noise ratio than is obtainable with earlier systems.

## Laboratory Apparatus

A block diagram of a complete magnetic recording system employing a supersonic bias field is shown in Fig. 1. The recording medium used for the work described in this paper was in the form of round wire; longitudinal magnetization was employed. For laboratory work the system was made as flexible as possible. Two well-shielded, recording-reproducing heads and an erasing head are used, making it possible to record and then play back a fraction of a second later. The auxiliary equipment includes amplifiers with flexible equalizers for recording and reproducing, oscillators with adjustable output and frequency for biasing and erasing, and an electronic speed control for the reversible-drive motor. Frequency-response measurements are made with an automatic frequency-response recorder.

Photographs of a loop tester for making tests with a short, endless loop of wire are shown. With this apparatus it is possible to test experimental recording, reproducing, and erasing heads, as well as sam-

ples of recording wire. Frequency response measurements, signal-to-noise ratio measurements and even listening tests can be made, as well as various other tests.

Magnetic recording is possible because certain ferromagnetic materials retain some magnetic induction after removal of an applied magnetic field. The portion which is retained is called remanence. For the benefit of those readers who may not be familiar with the distinction between remanence and residual induction in magnetic terminology the following definitions are given. *Remanence* is the magnetic induction which remains in a

magnetic circuit after the removal of an applied magnetomotive force. *Residual induction* in a magnetic material is the magnetic induction at which the magnetizing force is zero when the material is in a symmetrically cyclicly magnetized condition. Remanence is usually less than residual induction because of the self-demagnetizing field.

## Magnetic Materials

The relation between the residual induction and the field intensity by which it is produced is not linear. A graph showing the normal magnetization curve and the residual induction curve for a sample of carbon-steel wire is shown in Fig. 2. Starting with a completely demagnetized recording medium, it can be seen that severe distortion will occur unless some means of biasing is used. A field alternating at a supersonic frequency can be used to provide this bias.

We shall now analyze the com-

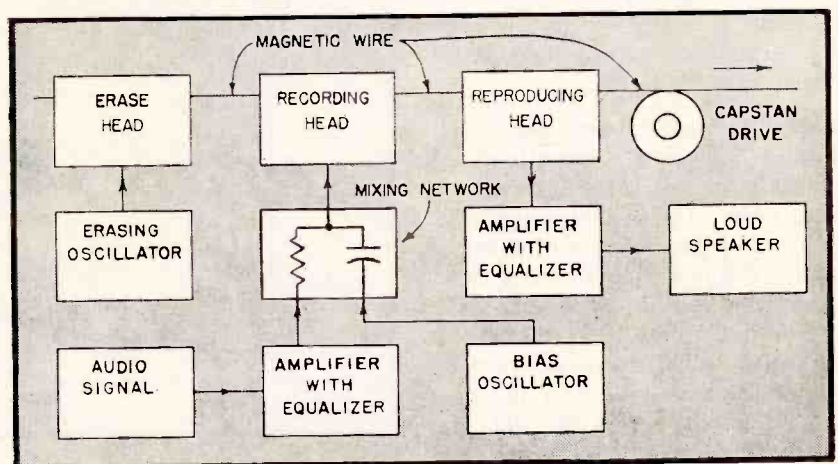

FIG. 1—Block diagram of an experimental magnetic recording system employing a supersonic bias field

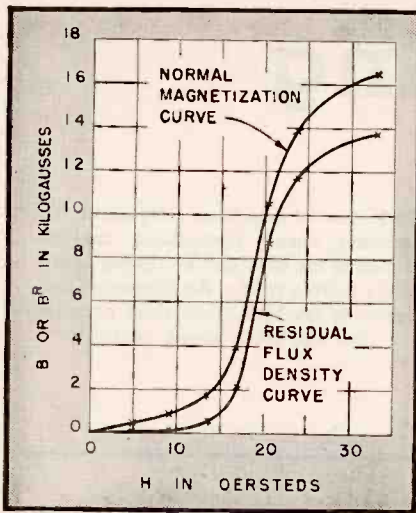

FIG. 2—Normal magnetization curve and residual induction curve for carbon-steel wire

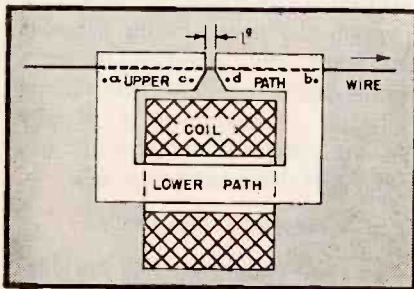

FIG. 3—Schematic diagram of a typical recording-reproducing head

combined action of the audio field and supersonic bias field from three points of view. In the first place, we shall examine the step-by-step relations as successive elements of the recording medium enter the recording gap. Next, we shall extend the analysis to show the averaging effect from point to point for a complete audio cycle. Finally, we shall show the analogy between these explanations and the commonly accepted graphical analysis for a pair of triodes in push-pull.

**Magnetic Action of Supersonic Field**

Figure 3 shows a schematic diagram of a typical recording-reproducing head. Let us now consider, step by step, the sequence of events taking place as a demagnetized element of the recording medium enters the recording gap from the seclusion of one of the poles, travels through the resultant field in the gap, and finally enters the slot in the second pole piece, where it is again shielded from the influence of the recording field.

The instantaneous value of field intensity in the gap,  $H_o$  can be expressed as follows

$$H_o = H_A \sin(\omega_1 t + \theta_1) + H_B \sin(\omega_2 t + \theta_2) \quad (1)$$

in which  $H_A$  is the maximum instantaneous value of the field due to the audio signal

$H_B$  is the maximum instantaneous value of the field due to the bias signal

$\omega_1$  and  $\omega_2$  are the angular velocities corresponding to the frequencies of these signals

$\theta_1$  and  $\theta_2$  are the relative phase positions of their respective signals

The graph of Fig. 4(a) shows curves of instantaneous values of field intensity in the gap, together with the audio component for a typical case.

Assume that the gap length is such that 1.5 cycles of bias signal will have been completed during the passage of the element of recording medium through the gap. This means that as each element passes through the gap, it will be subjected at least once to a field corresponding to the instantaneous audio signal plus the peak value of bias field in the same direction. The resultant maximum instantaneous field is the one which in large measure determines the value of the remanent flux density.

The graphs in Figure 4(b) illustrate three possible cases for suc-

cessive elements entering the recording gap during a positive half-cycle of audio signal. Let us refer to the first of these graphs and consider in detail the phases through which an element of recording medium passes as it is subjected to the varying resultant field in the gap. Assume that the element enters the gap in a demagnetized state at time  $t_1$ , at which time the resultant field is zero. As the field rises to its first positive maximum value  $P$ , the flux density in the element follows the initial magnetization curve to point  $P'$ . Succeeding variations  $PQRS$  in the resultant field cause the flux density to follow the path  $P'Q'R'$  to  $S'$ . At this instant the element is assumed to start to enter the second pole piece, the resultant field acting on the element remanent flux density corresponds to the signal recorded on the element. The other two graphs represent the changes in flux density for elements entering the gap at  $t_2$  and  $t_3$ . A linear system exists only if the values of remanent flux density are in direct proportion to the corresponding instantaneous values of audio signal.

It should be noted that this analysis differs considerably from a recently published explanation of the function of the supersonic bias

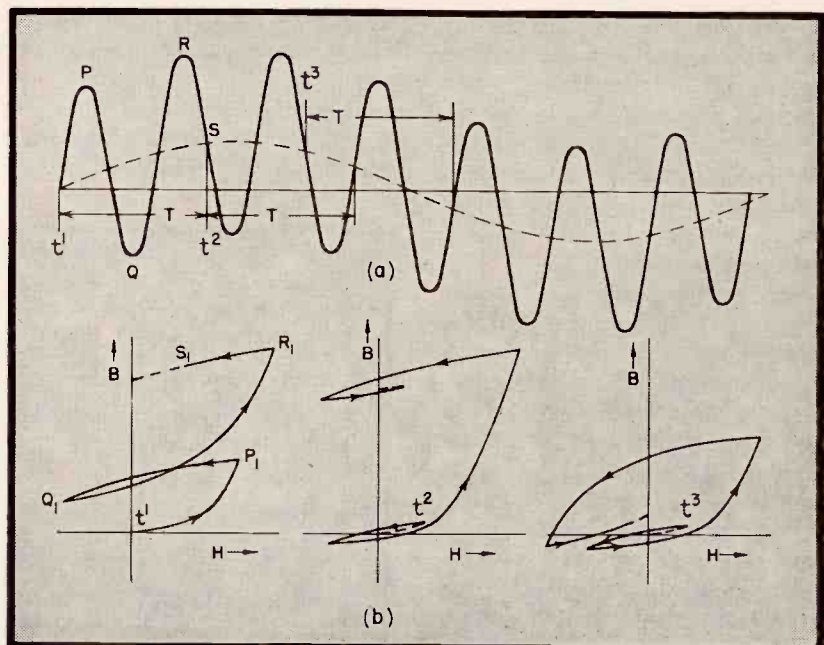

FIG. 4—(a) Curves of audio field and resultant supersonic field in the recording gap. (b) Curves showing assumed changes in gap field intensity acting on elements of recording medium

field in that each of the curves in Fig. 4(b) starts from the origin and cannot be assumed to be a part of or attached to any hysteresis loop.<sup>1</sup> It is well-known that several cycles with constant maximum values of field intensity must be completed before the induction in a given magnetic material can be assumed to follow the same path around either a major or a minor hysteresis loop. In a practical case there is not enough time to produce a stabilized major loop because there is considerably less than one-half cycle of audio signal during

The resulting current in the recording coil and field strength in the gap should be a simple mixed signal without modulation.

When no audio signal is present, the record on the wire will consist of a signal of supersonic frequency and of low amplitude. The amplitude will be low for two reasons. In the first place, the magnitude of the bias field is adjusted to a value which will just bring the operating point for zero audio signal up to the lower knee on the residual magnetization curve. The corresponding value of residual flux density for

small variations are eliminated because any practical reproducer will not respond to the bias frequency.

This being the case, we can analyze the performance of the system during recording as follows. Referring again to Fig. 5, the positive peak values of resultant field are projected up to the residual-flux-density curve. The corresponding residual-flux-density values are plotted on the time axis at the right as curve A. The construction for the second positive peak is shown. The negative values are found in a similar manner and are plotted as

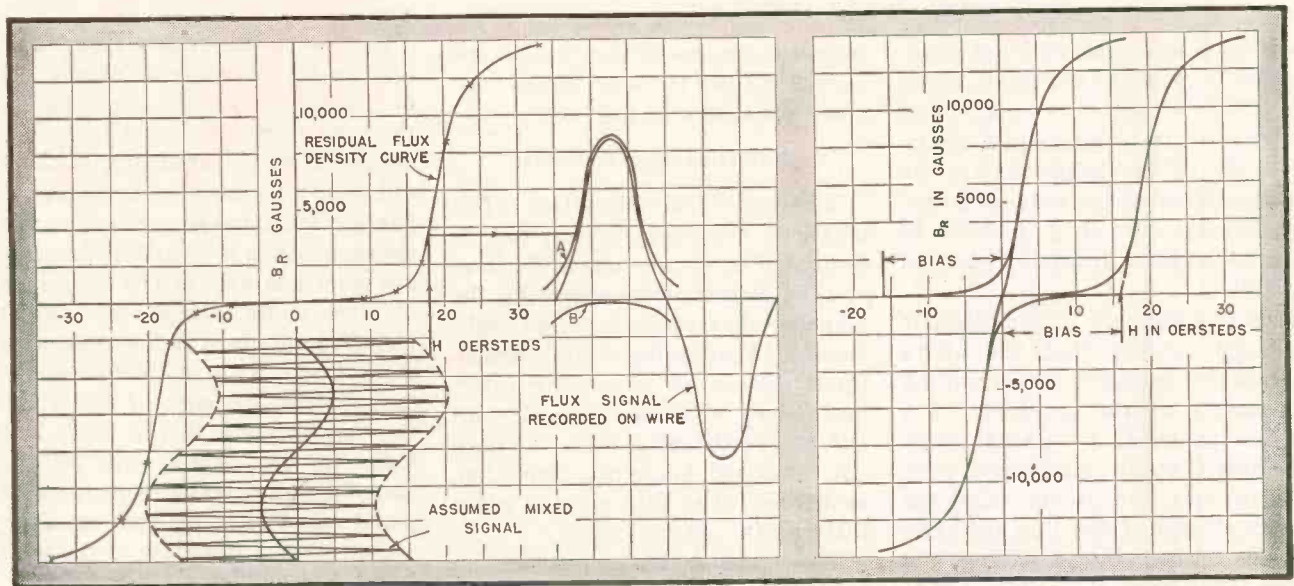

FIG. 5—Graphical analysis shows the combined actions of the audio and supersonic fields in the recording gap. Construction shows how recorded flux is obtained from combined magnetizing fields and magnetization curve

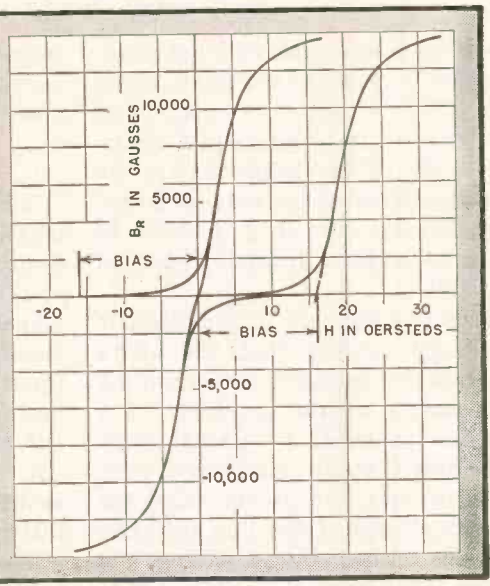

FIG. 6—Determination of correct bias field and construction of overall magnetic transfer characteristic

the passage of an element through the gap. Neither can stabilized minor loops, due to the bias field, be assumed because for even a relatively high value of bias frequency only three or four cycles will be completed during the transit time of an element across the gap. Furthermore, the audio signal is never quite constant, even for this short time interval.

#### Analysis of Magnetic Transfer Characteristics

An extension of this step-by-step analysis to explain the averaging effect for a complete audio cycle is shown in Fig. 5. As shown in the block diagram of Fig. 1, the supersonic bias signal is mixed with the audio signal in a mixing network.

most ferromagnetic materials is low. In the second place, self-demagnetization is very pronounced at the supersonic frequency which is used for the bias field because this frequency corresponds to short magnet lengths on the recording medium. Thus the effective remanence is still lower than indicated by the curve under the condition of zero audio signal.

Now assume a sinusoidal audio signal to be superimposed on the supersonic bias field. Although in this case the combined signal recorded on the wire will have small variations corresponding to the bias frequency, it will have short time average values which are nearly proportional to the instantaneous magnitudes of the audio signal. The

curve B. The sum of curves A and B represents the residual flux density. If self-demagnetization can be neglected, this represents the flux signal recorded on the wire.

It can be seen that some distortion is still present, although the distortion has been reduced greatly from what it would have been without the bias field. Some further reduction could probably be obtained by a more judicious choice of bias and audio signals.

The distortion with high-level audio signals cannot be reduced by adjustment of the bias because this distortion is due to the upper bend of the residual-flux-density curve. An increase in the bias field beyond that giving minimum distortion with low-level audio signals only re-

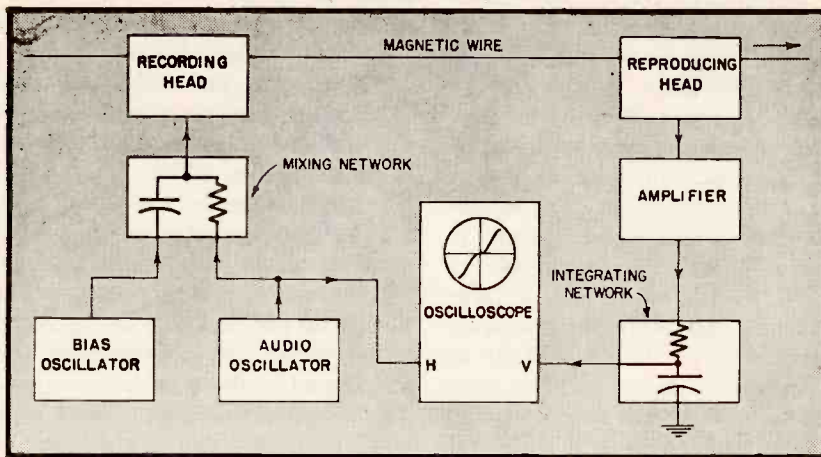

FIG. 7—Block diagram of the equipment for experimental observation of the overall magnetic transfer characteristic

sults in deterioration of the high-frequency response and reduction in the length of the linear portion of the over-all transfer characteristic. It is obviously desirable to have the linear portion of the over-all transfer characteristic long in order to have as large a dynamic range as possible.

The thought will probably occur to many readers that the above analysis is somewhat similar to the explanation of the operation of a pair of triodes as a class-AB push-pull amplifier. In accordance with this analogy, the proper value for the amplitude of the bias field can be determined by extending the steep portion of the residual-flux-density curve downward until it intersects the zero axis and reading the corresponding value of field intensity. The positive and negative portions of the curve can be shifted to the left and right respectively by the amplitude of the bias field, and the overall transfer character-

istic can be considered to be the sum of the two portions. These relations are shown in Fig. 6.

#### Distortion Measurements

The non-linear distortion of a magnetic recording system can be evaluated in several ways. We have studied distortion by observing the transfer characteristic on an oscilloscope, by obtaining output-versus-input curves, by measuring intermodulation with two-frequency input, and by listening tests. We have not measured harmonic distortion, as we feel that this method gives little useful information.

The transfer characteristic can be observed on an oscilloscope if variations in the wire speed are very small. A signal from an audio oscillator is recorded on the wire in the usual manner and is also applied to the horizontal plates of the oscilloscope. The recorded signal is reproduced an instant later in a reproducing head located near the

recording head, but well shielded from its stray-field influence. This signal is amplified and passed through an integrating network to the vertical plates of the oscilloscope. A block diagram for this setup is shown in Fig. 7. It is necessary to adjust the frequency of the audio oscillator so that the delay introduced while the wire travels from the recording head to the reproducing head is an integral number of half cycles. The integrating network is necessary because the output from the reproducing head depends upon the rate of change of flux through its magnetic circuit.

By use of this rather simple setup, the transfer characteristic can be observed while the amplitude of the bias or audio signal is varied, or the transfer characteristics of different wire samples can be compared. Photographs of transfer characteristics obtained in this way are shown in Fig. 8. The amplitude of the audio signal was great enough to produce overloading with correct bias, as is evident from the curvature at the ends of the transfer characteristic in Fig. 8(c). The loops in the oscillograms of the transfer characteristics are due to phase distortion in the amplifier and to slight instability of the wire speed and oscillator frequency.

#### Curvature of Transfer Characteristics

Output-versus-input curves are useful in finding out quickly the limit of input signal level, the corresponding magnitude of the output signal from the reproducing head, and the noise level. If these curves

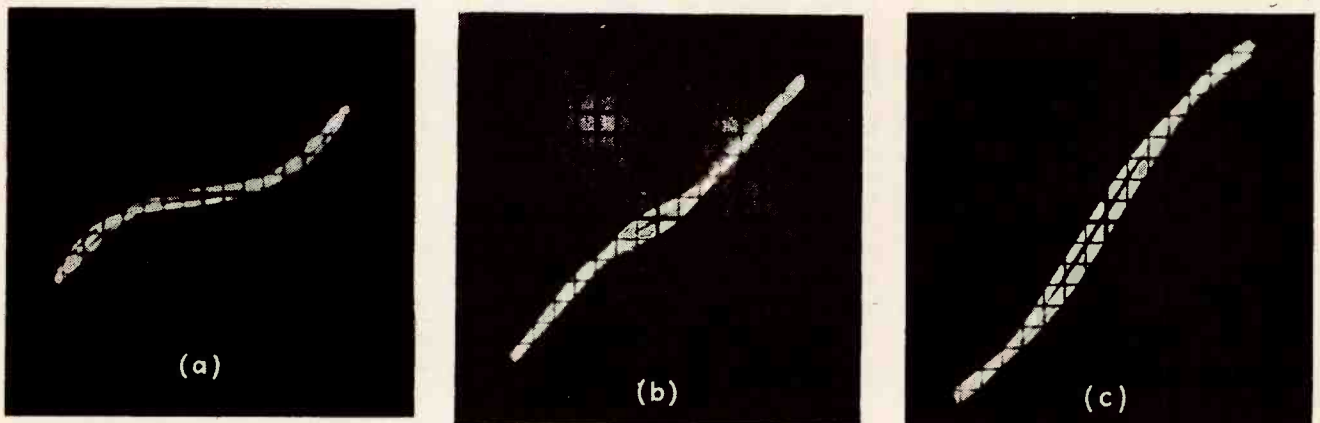

FIG. 8—Photographs of transfer characteristics as reproduced on an oscilloscope show the effect of supersonic bias; (a) no bias; (b) insufficient bias; (c) correct bias

are plotted in decibels, they should be straight lines rising at a 45 degree angle over the range of input which gives linear operation. The point at which the curvature becomes appreciable is a fair indication of the maximum input signal that can be used and the maximum output signal available. Typical curves taken at several frequencies are shown in Fig. 9. It is apparent from these curves that the input current at which overloading starts is about the same at widely different frequencies. In some cases, however, overloading occurs with lower input levels at the higher frequencies. The use of these curves in determining signal-to-noise ratio will be discussed later.

Intermodulation measurements afford a more accurate method of determining distortion than either of the two discussed. This method consists of simultaneously recording two sine waves, one of low frequency and large amplitude and the other of high frequency and small amplitude, and of measuring in the output of the reproducing head any resulting modulation of the higher-frequency component by the lower.<sup>2</sup>

Figure 10 shows typical modulation envelopes of the high-frequency component for conditions of no bias, insufficient bias, and correct bias. The corresponding percentages of modulation are: 65 percent, 25 percent, and 32 percent, respectively. The oscillograms of the modulation envelopes were taken with the same peak audio signal and the same values of bias as the correspondingly lettered transfer characteristics in Fig. 8.

As mentioned before, overloading and consequent modulation occurred with correct bias because of the large amplitude of the audio signal. If the amplitude of the audio signal is reduced somewhat and the bias is left at the correct value, the transfer characteristic becomes nearly straight, the modulation envelope nearly uniform in width, and the percentage of modulation correspondingly low.

#### Procedure for Listening Tests

The listening test is the final criterion in judging a recording system. It has been found convenient to make listening tests by re-record-

flexible equalizer for both low and high frequencies. The playback amplifier includes a flexible low-frequency equalizer. A dual-coaxial speaker having substantially uniform response from 80 to 10,000 cps. is used. An additional high-quality amplifier fed from the same 9-A pickup is used for playing the transcriptions directly. Arrangements can be made for comparing the two systems on the same loudspeaker by quick switching. When using the magnetic wire loop tester there is sufficient delay between recording and reproducing so that the same phrase can be heard first from the transcription and then from the magnetic recording. This test gives much better comparisons than listening to an entire selection, first from a transcription and then from a magnetic recording. When the level of the two systems is the same, quick switching is the best method we know of for showing significant differences introduced by the magnetic recording system.

#### Frequency Response

Magnetic recording is a phenomenon depending on current. The field intensity in the recording gap is nearly directly proportional to the mmf of the coil and this mmf is directly proportional to the current in the coil. The current in the coil can be made practically independent of the frequency of the input signal voltage by using a series resistance which is large compared with the reactance of the coil. With constant input voltage this should result in nearly the same value of field intensity in the gap for all fre-

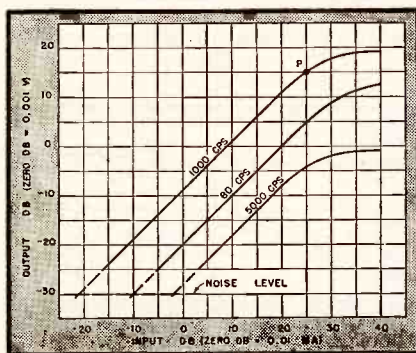

FIG. 9—Typical input-output curves for constant frequency show the range of linear response of the magnetic wire at various frequencies

ing from high-quality vertically-cut Vinylite transcriptions. The pickup used is a Western Electric 9-A. The recording and playback amplifiers contribute a total of not more than about 4 percent intermodulation, and 1 percent harmonic distortion. The recording amplifier includes a

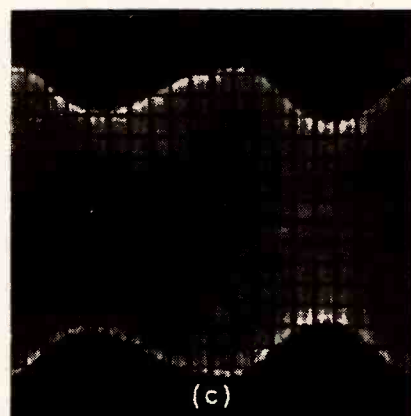
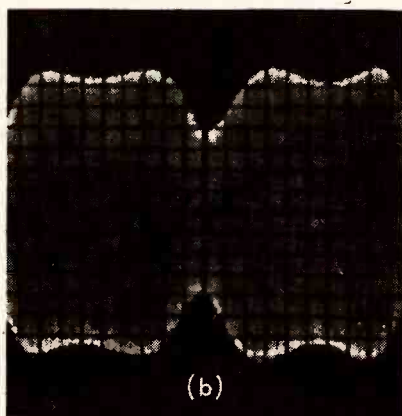
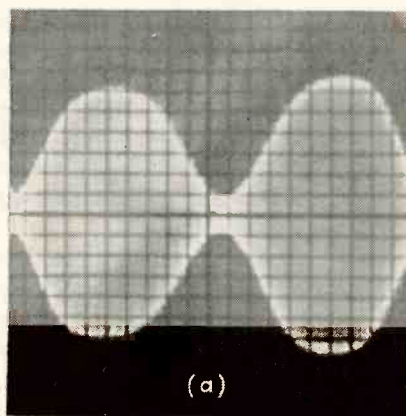

FIG. 10—The modulation produced by one audio frequency on another indicates curvilinear transfer characteristics. The greatest cross modulation occurs with no bias (a). As the bias is increased

(b) the modulation decreases. Although the percent modulation shown at (c) is greater than at (b), fewer sidebands are produced, thus this condition represents the optimum supersonic bias

quencies within the desired range. Unless otherwise specified, all of the frequency response characteristics to be discussed or shown represent the open-circuit voltage at the terminals of the reproducing head and are recorded with constant-current.

Under these conditions, if we disregard for a moment the serious demagnetization effect which takes place with short magnets, the magnitude of the residual flux density should be independent of the frequency. The length of the individual magnets is inversely proportional to frequency. Hence, as the frequency increases, the magnets become shorter. Because the flux lines must pass through the surface of the wire and through the air or other medium to a pole of opposite polarity, the surface density of the lines increases in direct proportion to the frequency, even though the maximum internal density across the sectional area of the wire may remain constant.

#### Effect of Air-Gap Length

The time rate of change of the lines leaving the surface of the wire at a north pole and returning through the magnetic circuit of the reproducing head to a nearby south pole determines the value of emf induced in the reproducing head. The maximum rate of change for a constant total number of lines is thus directly proportional to the frequency. This should produce a constant rise in output with frequency at the rate of 6 db per octave. Actually, this is found by measurement to be nearly true only at the lower frequencies. As the frequency is increased, the air-gap length in the reproducing head influences the frequency response according to the following equation:

$$E = KB_m S_w \sin\left(\frac{\pi l_g}{\lambda}\right) \quad (2)$$

- $E$  is the rms voltage at the terminals of the coil  
 $B_m$  is the maximum value of the remanence corresponding to the maximum instantaneous audio signal  
 $S_w$  is the wire speed  
 $\lambda$  is the wavelength corresponding to the audio signal recorded on the medium  
 $l_g$  is the air gap length in the reproducing head  
 $K$  is a constant depending on the units, and also upon the coupling between the wire and the

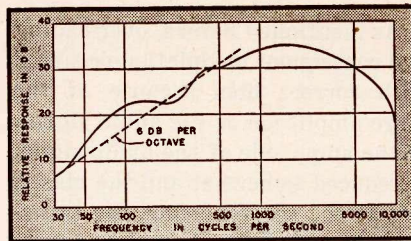

FIG. 11—Experimental frequency-response curve for constant-current magnetic recording

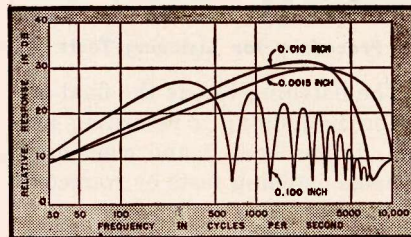

FIG. 12—Effect of gap length on frequency response

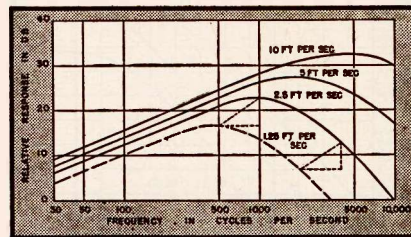

FIG. 13—Effect of wire speed on frequency response; solid curves were obtained experimentally, dashed curve was obtained graphically

magnetic circuit, as well as the size and configuration of the magnetic circuit, and on the properties of the reproducing coil itself

At low frequencies  $\sin \pi l_g / \lambda$  is approximately proportional to the frequency and the output voltage should rise at the rate of nearly 6 db per octave. At higher frequencies  $\sin \pi l_g / \lambda$  is not proportional to the frequency and at a frequency such that  $l_g = \lambda / 2$ , the output voltage reaches a maximum, then falls to zero when  $l_g = \lambda$ . The voltage again increases to a maximum at a frequency such that  $l_g = 3/2 \lambda$ , falls to zero at  $l_g = 2 \lambda$ , etc. A typical frequency response curve for constant-current recording is shown in Fig. 11.

The effect of using gaps of different lengths for the reproducing head is shown in Fig. 12. For the long gap there is much better correlation between the calculated and observed values of frequency at which maximum response occurs

than with the short gaps. This is true for two reasons. In the first place, fringing effect causes a smaller percentage increase in the effective length of a long gap than of a short gap. Secondly, with a long gap, the demagnetizing effect is negligible at the frequency of the first maximum, whereas with a short gap, the demagnetizing effect tends to reduce the output voltage at the higher frequencies, resulting in a reduction in the frequency at which the first maximum response occurs.

#### Effect of Speed on Frequency Response

The speed at which the recording medium is driven has a pronounced effect on the high-frequency response of a magnetic recording system. On the other hand, the speed has only a slight effect at low frequencies. This is shown by the experimental curves of Fig. 13, which were all taken with the same input level. For simplicity the peaks and dips in the low-frequency region were averaged out when the curves were redrawn.

The more pronounced effect of speed on the high-frequency response is caused by self-demagnetization and by the relation between wavelength and gap-length. At low frequencies self-demagnetization is negligible, so that the remanent flux density is independent of wavelength and hence of the speed which, at any given frequency, determines the wavelength.

At the higher audio frequencies self-demagnetization is pronounced and, at a fixed frequency, increases rapidly as the speed is reduced. This results in a reduction in the high-frequency response. The high-frequency response also deteriorates when  $\pi l_g / \lambda$  lies between  $\pi/2$  and  $\pi$ . In a practical system, the wire speed is made such that this occurs near the upper end of the working frequency range.

Both of these effects are important, but the experimental determination of the relative reduction in response caused by either is difficult.

Assuming a given fixed wavelength recorded on the wire, the demagnetizing effect and the effect of the gap-length will be constant and

independent of the speed at which the wire is driven. Both the output voltage and its frequency will then be directly proportional to speed. Knowing this, it is easy to find the constant-current frequency response at any wire speed from the response curve at a known speed by a simple graphical construction. A right triangle is drawn with its hypotenuse rising 6 db per octave. The length of the base is taken as the distance on the logarithmic frequency scale between two frequencies having the same ratio as that of the known speed to the speed at which the frequency response is desired. An example of this construction is shown in Fig. 13 where the dashed curve represents the frequency response at 1.25 feet per second as obtained from the response at 2.5 feet per second. The dashed curve is traced by the lower left hand corner of the triangle as the apex is moved along the response curve for 2.5 feet per second while the base is kept parallel to the zero axis.

#### Recording-Reproducing Heads

In spite of the fact that the frequency response for a given medium can be modified somewhat, especially at the higher frequencies, by changes in the design of the recording head, we find that these modifications are small as compared with those which occur with minor changes in the reproducing head. For practical reasons, it is desirable to use the same head for both recording and reproducing. Therefore the limitations imposed by the playback conditions are the ones which ordinarily control the design. The power required for recording is in the order of a few milliwatts, so that this does not impose any severe limitation on the amplifier design, even if a recording head with low recording efficiency is used.

For playback, the design of the reproducing head is very critical. The gap must be short in order to obtain good response at the higher audio frequencies. The material should have as high a permeability as possible at low flux densities. The eddy-current losses should be low in order that the high-frequency response will not be impaired. The

magnetic coupling between the recording medium and the head should be good, especially in the immediate vicinity of the gap. On the other hand, the magnetic coupling between the recording medium and the head at the points of entry and exit should be kept as low as possible in order to reduce the magnitude of the secondary or stray flux which may produce certain undesirable variations in the frequency-response curve.

#### Effect of Coil Location

Let us consider the manner in which these undesirable variations are produced. If we refer again to Fig. 3, it can be seen that the passage of the wire through the slot in the reproducing head sets up an alternating magnetic potential between points *a* and *b*, and at the same time another alternating magnetic potential is set up between *c* and *d*. The magnetic potential between *a* and *b* reaches a maximum effective value at a relatively low audio frequency in a playback head of practical size. Alternate dips and peaks occur in the effective values of this magnetic potential at regularly spaced frequency intervals, depending upon the wavelength recorded on the wire relative to the effective width of the reproducing head. We shall call the flux due to this magnetic potential the secondary or stray flux.

There are two paths for this stray flux. One is directly across the top of the head and through the gap. The other is from *a* down through one of the vertical legs, across the lower leg and up the other vertical leg to point *b* in Fig. 3.

The alternating magnetic potential existing between *c* and *d* is the one which gives the useful response. There are also two paths for the flux produced by this alternating magnetic potential. One of these is directly across the gap. The other is around the complete magnetic circuit in a counter-clockwise direction for the positive values of magnetic potential.

Now consider the coil to be mounted as shown in Fig. 3. The resultant alternating flux and emf produced are the result of two alternating magnetic potentials. The useful component increases with

frequency, according to the equation previously given. As mentioned above, the other component passes through several positive and negative peaks as the frequency changes over the audio spectrum. The total response will now show peaks and dips which become less pronounced as the frequency is increased.

If the coil is moved to a position where it surrounds the upper leg of the circuit, a similar response curve will result, except that the phase of the emf due to the stray flux is reversed, causing the positions of the peaks and dips to be interchanged. Experimental curves showing these effects are given in Fig. 14.

#### Correlation Between Magnetic Characteristics and Frequency Response

In the design of permanent magnets, great stress is attached to the proper shape and size of the magnetic circuit so that the permanent-magnet material may be used at or near the point of maximum energy. This makes the most efficient use of the costly alloys which are used for permanent magnets. Such a design is not possible for the case of a medium used for magnetic recording because the ratio of length to diameter for the individual magnets which make up the record varies from a value which is large at low frequencies to one which is less than unity at the higher frequencies.

The retentivity of the magnetic recording medium for a given wire speed determines the maximum value of the output voltage at the lower audio frequencies. At these frequencies the wavelength is relatively long and self-demagnetization is not serious. For this reason, one would expect to have good bass response for materials with high retentivity. A large number of our experimental frequency-response curves have shown this to be true.

The second magnetic characteristic which affects the frequency response to a very great degree is the coercive force of the material. The demagnetizing field intensity can be considered to be equal to the product of the demagnetization factor and the remanent flux den-

sity. The demagnetization factor increases in magnitude as the ratio of the length of a permanent magnet to its diameter decreases. Whether or not the flux density is greatly reduced because of the demagnetization factor depends on the shape of the demagnetization curve, and especially upon the value of the coercive force.

The effect of demagnetization is less with materials having high coercive force. It is generally considered to be true that a magnetic material which has high coercive force will also have low retentivity. This is especially true of many of the materials which are being considered for use in magnetic recording. This means that we may have to sacrifice some output voltage at the lower audio frequencies in order to extend the upper frequency range by use of a material which has high coercive force but low retentivity.

#### Mechanical Sources of Noise

At the present time we cannot say that magnetic recording gives a system with negligible noise. We can say, however, that for a given reproduced-frequency bandwidth and for carefully controlled laboratory recording and reproducing conditions, the background noise is considerably less than that for the corresponding-frequency bandwidth on shellac records, but that it is not as low as the background noise on vertically-cut Vinylite transcriptions.

Mechanical imperfections in the wire which result in changes in sectional area along the wire may be responsible for the generation of noise voltages in the coil of the playback head. For a wire diameter of 0.004 inch, a variation in diameter of 0.0001 inch corresponds to an area change of about 5 percent. Corresponding changes in the recorded flux signal appear as noise when reproduced. If the variation in diameter is random, random noise will result. However, if the imperfections occur at regularly spaced intervals along the wire, a distinct tone will appear.

Either transverse or longitudinal vibrations of the medium as it is drawn through the reproducing head may also be the cause of unde-

sirable background noise. These vibrations may be produced either by the irregular surface of the wire or by nonuniform torque anywhere in the driving system. These vibrations of the medium result in corresponding pulsations of flux linkages through the coil and a noise voltage in addition to the signal voltage appears at the terminals of the playback head.

#### Magnetic Noise Sources

We have found that although different wires may seem to be perfectly uniform in external appearance, they may vary considerably in noisiness. Some samples show an absolute noise level which is 20 db greater than that of some other samples. Although we have not yet been able to correlate the noise level with the composition, heat treatment, and degree of cold work used in preparing the samples, we think that it depends on the final magnetic structure which in turn is determined by these factors.

The magnetic noise increases in the presence of a recorded signal. This can be demonstrated by recording a sine-wave signal on the medium and filtering out the signal and its harmonics in the reproducing system. The reproduced noise will have frequency components distributed throughout the band passed by the filter. This noise increases as the amplitude of the recorded signal is increased and is reduced to a low value after the medium has been subjected to the erasing field. It seems probable that this noise is caused by the finite size of the elementary magnetic particles of the medium. A certain amount of such noise is not noticeable, as it is ordinarily masked by the signal. However, an excessive amount imparts a disagreeable fuzzy quality to the reproduction. It was pointed out earlier that any magnetic recording system using direct-current bias ordinarily leaves the recording medium magnetized even in the absence of an audio signal. In this case, the noise is particularly bad because there is no signal to mask it.

Equation (2) indicates that the noise voltage should increase with wire speed. This is confirmed by our measurements which show that

the noise level rises at least 6 db each time the speed is doubled.

Another effect which may contribute to the noise is so-called crosstalk. This is the effect of adjacent turns or layers of the recording medium on each other when wound on a spool for storage. It is possible for one turn of strongly magnetized recording medium to magnetize an adjacent turn. This re-recorded signal may show up as objectionable noise, particularly during quiet passages of a selection where it would not be masked by the desired signal. Crosstalk can be reduced to a negligible amount by choosing a recording medium having low retentivity and high coercive force.

In considering noise, that originating in the reproducing system should also be mentioned. The signal output from a high impedance reproducing head is of the order of only a few millivolts, which makes it necessary to use a large amount of amplification. The amplifier must be carefully designed to minimize thermal noise and to be free from hum. In addition, the effects of stray electrostatic and electromagnetic fields on the reproducing head must be minimized by shielding or other means. The problem of eliminating hum is aggravated when post-equalization of the low frequencies is used. This is apparent from the fact that 15 or 20 db of equalization at 60 cycles is necessary in some cases for flat response.

#### Loss of Output Signal With Repeated Playings

There have been many general statements concerning the permanency of the records on magnetic wire. Much more information than we have at present is needed before we can make well-founded statements concerning the ability of the wire to retain a record indefinitely without loss. Experiments show that there is a loss of from 3 to 25 db in output from a given record during the first few playings. After this initial aging process there seems to be little further loss for a reasonable time and a reasonable number of playings. In general, materials which have properties desirable from other view-



points tend to show small loss with repeated playings. As far as we know, no great difficulty has been experienced on account of this effect.

### Equalization and Signal-to-Noise Ratio

Once the factors affecting the maximum signal and those affecting the noise have been determined, the problem of determining the effective signal-to-noise ratio remains. The effective signal-to-noise ratio depends not only upon the factors already discussed but also upon the frequency distribution of the noise, the frequency distribution of the speech or music to be recorded, and upon the amount of pre-equalization and post-equalization.

It has been accepted practice in some other fields to record with a characteristic rising toward the high frequencies and equalize in the reproducing circuits to give an overall flat response. It has been found that some increase in the signal-to-noise ratio can be accomplished by this practice. In the case of magnetic recording, however, it is not feasible to use a comparable amount of such pre-emphasis and post-equalization because at the speeds which are desirable for recording, the frequency response at the higher audio frequencies falls off very rapidly. However, even in this case, enough pre-equalization can be used to make the overall response flat within a specified frequency range. Post-equalization for increasing the high-frequency response is not desirable, because the objectionable noise has been found by rough measurements and by listening to occur largely at medium and high frequencies. Post-equalization would amplify the noise as well as the signal.

Due to the fact that, in reproduction, the low-frequency response of the system is inherently lower than the response in the middle-frequency range, some form of bass equalization must be used. It is not feasible to use sufficient pre-equalization to obtain even flat overall response because the wire will not accept the resulting large recording signals without overloading. A sufficient reduction of the recording level to permit the use of pre-equal-

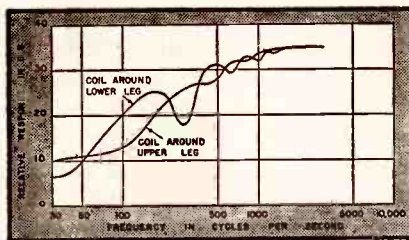

FIG. 14—Experimental curves showing that peaks and dips in the frequency response are dependent upon coil placement

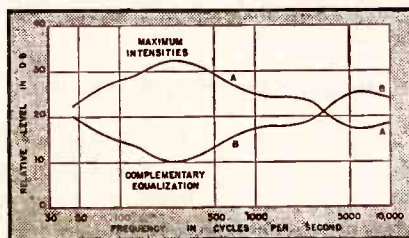

FIG. 15—Curve A shows frequency distribution of maximum sound intensities for a symphony orchestra. Curve B shows the desired complementary pre-equalization.

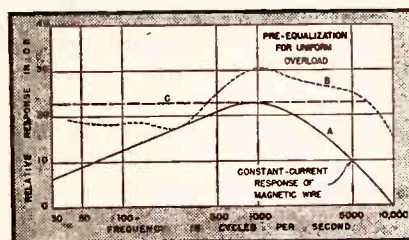

FIG. 16—By using a pre-equalization network having the characteristics of curve B, which is the sum of curve A in this figure and curve B in Fig. 15, overloading of the magnetic tape is equally likely to occur at all frequencies

ization would result in a less favorable signal-to-noise ratio. On the other hand, post-equalization is feasible because the amount of noise in the low-frequency region is small.

### Equalization Against Overload

The following example serves to illustrate the application of these principles to a practical magnetic recording system. Curve A of Fig. 15 represents the frequency distribution of the maximum intensities occurring in symphony orchestra music.<sup>3</sup> This curve is drawn at a level which is exceeded by 5 percent of the peaks and can be used as an indication of the relative levels which must be accommodated by the system at various frequencies. Having this information, it is possible to decide upon the amount and type of equalization which will result in the highest signal-to-

noise ratio, and to arrive at the approximate value of the signal-to-noise ratio.

From curve A of Fig. 15 it is apparent that with constant current recording the system will overload most often at about 250 cps. In order to make the most effective use of the system it would be desirable to have overloading occur equally often at all frequencies. This can be done by using pre-equalization which is complementary to curve A of Fig. 15, as shown by curve B of the same figure.

Passing on to Fig. 16, there is shown (curve A) a typical, smoothed constant-current response curve. This is the curve at 2.5 feet per second replotted from Fig. 13. If we now take the complementary equalization curve B of Fig. 15 and add it to this constant-current response curve we obtain curve B of Fig. 16 representing the over-all frequency-response of a system which has equal probability of overloading at all frequencies under the conditions assumed. This curve is obviously unsatisfactory from the standpoint of frequency-response, but is useful as a guide in determining the maximum amount of pre-equalization that may safely be used. For example, a useful amount of pre-equalization may be employed below about 250 cps and the remaining equalization found necessary to secure flat over-all response may be applied to the reproducing circuits. We have found that such low-frequency post-equalization does not appear to raise appreciably the random-noise level.

### Upper Frequency Limit

Turning now to the upper portion of the frequency range we find that, without loss in signal-to-noise ratio, the high-frequency response can be made flat out to the frequency at which the uniform overload curve intersects a flat response line C drawn through the highest level of the constant-current response curve. The signal-to-noise ratio can then be taken as the difference between the level of the maximum undistorted output signal at the frequency of maximum response and the noise level. If it is desired to extend the frequency range, this can only be done with a

sacrifice in signal-to-noise ratio.

For example, with the system for which curves are shown, when the high-frequency response is made flat up to 6500 cps, the maximum inherent capacity of the system can be utilized. If the flat response is extended to 9000 cps a loss of 5 db in signal-to-noise ratio will result. This loss is the difference between the level of the flat-response line drawn through the maximum level of the constant current curve and the ordinate of the uniform-overload curve at 9000 cps.

The maximum undistorted signal can be defined for the present purpose as that at which the output-versus-input curve for the frequency of maximum response departs 1 db from linearity. This is represented as point *P* on the 1000-cycle curve of Fig. 9. For the curves shown, the signal-to-noise ratio according to our definition would be 45 db for flat response to 6500 cps, and 40 db for flat response to 9000 cps.

The foregoing example tends to give an optimistic picture of the performance under the assumed operating conditions first, because it has been assumed that overloading occurs at equal input level regardless of frequency, and second, because it does not take account of magnetic noise. We have observed that overloading in some cases begins to occur with lower input current at the higher frequencies. The difference between the input level for maximum undistorted output signal at the frequency of maximum response and the corresponding value at the highest frequency in the assumed band must be subtracted from the signal-to-noise ratios obtained by the above method. For the example shown, however, this subtractive term amounted to less than one db at 5000 cps, which is negligible. Other measurements have shown that some materials show up to 15 db increase in their magnetic noise level with increase in recording signal. The sample for which the curves are shown was rejected on this account when a listening test was made.

The importance of judging a magnetic recording system by means of a critical listening test cannot be over-emphasized. Objec-

tive measurements such as frequency response, distortion, and noise measurements are invaluable in making a preliminary estimate of the quality of any component of a recording system and in pointing the way to improvements. However, the correlation between objective measurements and subjective effects is complex and not completely understood. Therefore, the listening test must always be used as the final criterion.

#### Magnetic Recording Possibilities

Our studies in connection with magnetic recording systems lead us to make the following general statements concerning the performance of present experimental systems and possible future improvements in magnetic recording systems.

Reasonable fidelity is possible at the present time. In order to get a system with low distortion, careful control of the bias field is necessary. The correct value of the bias field varies within wide limits for different recording media.

The signal-to-noise ratio which can be attained at present is superior to that which is obtained from the ordinary shellac disc recordings. It is not as good as can be obtained from the newest vertically-cut Vinylite transcriptions. We expect that improvement in the signal-to-noise ratio will result from further studies in connection with noise and that this will lead to improved recording media and improved design of the recording and reproducing heads.

It seems feasible at the present time to produce recordings at 2.5 feet per second on 0.004 inch diameter wire which are reasonably flat from 70 to 6500 cps. While the upper limit of frequency response may be raised by increasing the wire speed, it would appear more desirable to attempt to get better high-frequency response by improving certain magnetic properties of the recording medium. Actually it would be far more satisfactory from the viewpoint of cost to the consumer if the wire speed could be reduced to a still lower value, say 2 feet per second, or even 1.5 feet per second. These lower speeds seem to be quite satis-

factory for the reproduction of speech. There are indications that improved design of the recording and reproducing heads will be necessary in order to utilize fully the newer materials which are being investigated for possible use as magnetic recording media.

In conclusion it should be pointed out that we are not attempting to specify any definite standards for magnetic recording at this time. The examples which have been presented are given simply for the purpose of illustration and do not necessarily represent our ideas as to the most desirable frequency limits, limits of distortion, or wire dimensions, and speeds. The experimental frequency-response curves which have been given represent average, rather than superior, samples and they were made without using special recording and reproducing heads.

#### REFERENCES

- (1) Toomim, Hershel, and Wildfeuer, David, "The Mechanism of Supersonic Frequencies as Applied to Magnetic Recording," *Proc. I.R.E.*, p. 664-668, Nov. 1944.
- (2) Frayne, J. G., and Scoville, R. R., "Analysis and Measurement of Distortion in Variable-Density Recording," *Jour. of S. of M. P. E.*, 32, p. 648-673, June 1939.
- (3) Frequency Range and Power Considerations in Music Reproduction, Jensen Technical Monograph Number Three, Jensen Radio Manufacturing Company, Chicago.

#### BIBLIOGRAPHY

- (1) Barrett, A. E., and Tweed, C. J. F., Some Aspects of Magnetic Recording and Its Application to Broadcasting, *Jour. I.R.E.*, 82, p. 265-288, Mar. 1938.
- (2) Begun, S. J., Magnetic Recording and Some of Its Applications in the Broadcast Field, *Proc. I.R.E.*, p. 423-433, Aug. 1941.
- (3) Hickman, C. N., Sound Recording on Magnetic Tape, *Bell System Technical Journal*, 16, p. 165, 1937.
- (4) Hormann, E., Concerning the Theory of Magnetic Sound Recording, *Elektrische Nachrichten-Technik*, 9, p. 388, 1932.
- (5) Malloy, T. J., A Magnetic Recorder, *ELECTRONICS*, 11, p. 30, Jan. 1938.
- (6) Nagai, Kenzo, Sasaki, Siro, and Endo, Junosuke, Experimental Consideration upon the A-C Erasing on the Magnetic Recording and Proposition of the New Recording Method, Translation of about half of original paper which appears in Japanese in the *Journal of the Institute of Electrical Communication Engineers of Japan*, No. 180, Mar. 1938.
- (7) Pugsley, D. W., Engineering Details of a Magnetic Wire Recorder, *Electronic Industries*, 3, p. 116-118, Jan. 1944.
- (8) Camras, Marvin, A New Magnetic Wire Recorder, *Radio News*, Radionics Department, p. 3-5, Nov. 1943.
- (9) Selby, M. C., Investigation of Magnetic Tape Recorders, *ELECTRONICS*, p. 133-135, May 1944.
- (10) Sivian, L. J., Dunn, H. K., and White, S. D., Absolute Amplitudes and Spectra of Certain Musical Instruments and Orchestras, *Jour. Acous. Soc. Amer.*, 2, p. 330-371, Jan. 1931.
- (11) Steinberg, John C., The Stereophonic Sound Film System—Pre- and Post-EQUALIZATION of Compressor Systems, *Jour. Acous. Soc. Amer.*, 13, p. 107-114, Oct. 1941.
- (12) Fletcher, Harvey, Hearing, the Determining Factor for High Fidelity Transmission, *Proc. I.R.E.*, p. 266-277, June 1942.
- (13) Spooner, Thomas, "Properties and Testing of Magnetic Materials," McGraw-Hill Book Company, New York, N. Y., 1927.

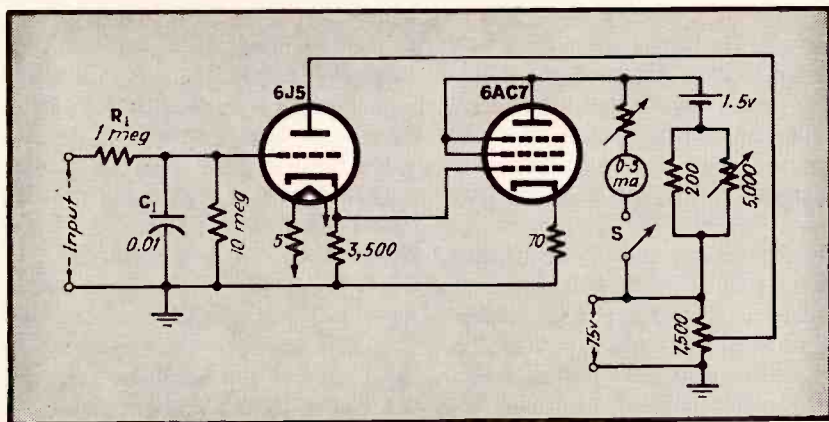

FIG. 1—Direct-current vacuum-tube voltmeter using a high-transconductance pentode isolated from the high-impedance input circuit by a triode connected as a cathode follower

# Improved VACUUM-TUBE VOLTMETERS

Full advantage can be taken of the high transconductance and linear transfer characteristics of pentodes by using a cathode-coupled triode in the vacuum-tube voltmeter input. Such a combination provides an instrument having both high input impedance over a wide frequency range and high sensitivity

By J. T. McCARTHY

*Assistant Professor of Physics  
Western Reserve University  
Cleveland, Ohio*

**M**ANY VACUUM-TUBE VOLTMETERS employ a d-c microammeter as an indicator, with 1.5-volts input giving a deflection of 100-200 microamperes. The sensitive indicating instrument is needed because, (for reasons of stability, linearity, and low grid-current) the amplifier tube is operated in a region of low transconductance, with large degenerative feedback. When the feedback is great enough, calibration can be made nearly independent of tube characteristics and changes.

Microammeters have been improved in recent years so that they are no longer regarded as expensive and fragile instruments. Many voltmeters employing them seem quite satisfactory. However, it appears that a milliammeter would still have advantages when expense, durability, and availability

are important. Furthermore, a stable voltmeter built to operate with a milliammeter at 1.5 volts input could have its range extended downward by the use of a more sensitive indicator.

#### Need for Greater Amplification

In order to use a less sensitive indicating instrument the vacuum tube must be operated in a region where its transconductance is high. Less degenerative feedback may be used but less is needed (for linearity at least) because the characteristic curve is more linear in this region. Although the use of television-type pentodes for voltmeters has occurred to several workers in the field, a tube of this type biased at a suitable operating point suf-

fers from a rather large flow of grid current. This causes the input impedance to be low and produces an error in reading, the degree of error depending upon the impedance of the source.

Turner<sup>1</sup> has not only pointed out in detail the types of tubes with high transconductance that might be used for voltmeters but has also suggested that high effective-transconductance could be obtained by operating two or more tubes in parallel. However, parallel operation of tubes suffers from two disadvantages: first, the input capacitance and conductance are multiplied; and second, the total plate current increases greatly, so that more is demanded of the power supply.

Yard<sup>2</sup> has used a high-transconductance tube in a conventional circuit and obtained a deflection of

5 ma for 1.5 volts input. The deflection can be doubled by using a separate battery or cell to balance out the initial plate current. This circuit suffers from a lack of linear response, a shift of the zero-setting with line-voltage fluctuations, and a low input impedance of about 1.5 megohms. The grid resistor cannot successfully be increased very much because of the flow of grid current. These difficulties are probably inherent in any voltmeter employing a single tube of high transconductance or two or more tubes in parallel.

### Cathode Coupling

It will be shown below that high-transconductance tubes can be used successfully in simple and inexpensive voltmeter circuits when some kind of input stage is used to provide high input resistance. High sensitivity and large output current result. The disadvantages accompanying small degenerative feedback are minimized by using balanced circuits and some means for quick calibration.

The circuit in Fig. 1 was designed to overcome, by sacrificing some simplicity, the shortcomings of the single-tube voltmeter. This d-c voltmeter is essentially a two-stage amplifier with the first stage serving only to couple the source to the second tube. The first stage is a cathode-follower arrangement and is highly stable because of the large degeneration. The 6J5 is operated with low voltages on the heater and plate in order to reduce the grid current in both tubes. The high side of the input is connected through a shielded lead with a 1-megohm isolating resistor, thus providing an input resistance of 11 megohms. This resistance could be made larger.

### Meter Characteristics

The bias for the 6AC7 is the algebraic sum of the voltage drops across the two cathode resistors. The initial plate current is balanced out by a No. 6 dry cell. Instead of this cell, a suitable voltage may be tapped from the bleeder resistance but this reduces somewhat the sensitivity. In order to protect the indicating instrument against ex-

cessive deflection, switch *S* is left open until the heater of the 6AC7 has warmed up. The sensitivity can be controlled by the rheostat in series with the milliammeter. The supply voltage is regulated by using a OA3/VR75 tube.

This voltmeter is strictly linear; the zero point is very stable and no appreciable grid current is observable in the 6J5. An input of 1.5 volts gives a full-scale deflection on a 5 ma instrument of 1 percent accuracy. The circuit is sufficiently stable so that, by means of a more sensitive indicator, the range of the voltmeter may be extended downward by a factor of two or three at least, depending upon the voltage fluctuations in the power line. The range may be extended upward by a conventional voltage-divider across the input. Because of the filtering action of the input circuit, d-c voltages can be measured correctly even in the presence of superimposed a-c voltages.

### Balanced Circuit

This type of coupling can also be applied to a balanced circuit to avoid employing a dry cell and

to stabilize more easily against line-voltage fluctuations. A stabilized power supply is usually not necessary and some simplification results. This is illustrated by the circuit in Fig. 2, a stable circuit with linear response. The two 6AG7 tubes and the two sides of the 6SN7-GT should be approximately matched for optimum stability. The milliammeter is connected to the plates of the amplifier tubes in the conventional bridge circuit. A deflection of 10 ma can be obtained for an input of 2 volts but the circuit is usually operated conservatively with the constants shown so that 1.5 volts produces a reading of 5 ma. When a 1-ma meter is used, satisfactory performance is obtained with a full-scale deflection corresponding to 0.3 volt. Slight effects of line-voltage fluctuations are observable at this sensitivity.

Although other types of tubes were tried in this circuit, the 6AG7 gave maximum sensitivity. The response with 6AC7's is only slightly lower however, and these tubes have the advantage of lower plate current (20 ma for two 6AC7's instead of 35 ma for two

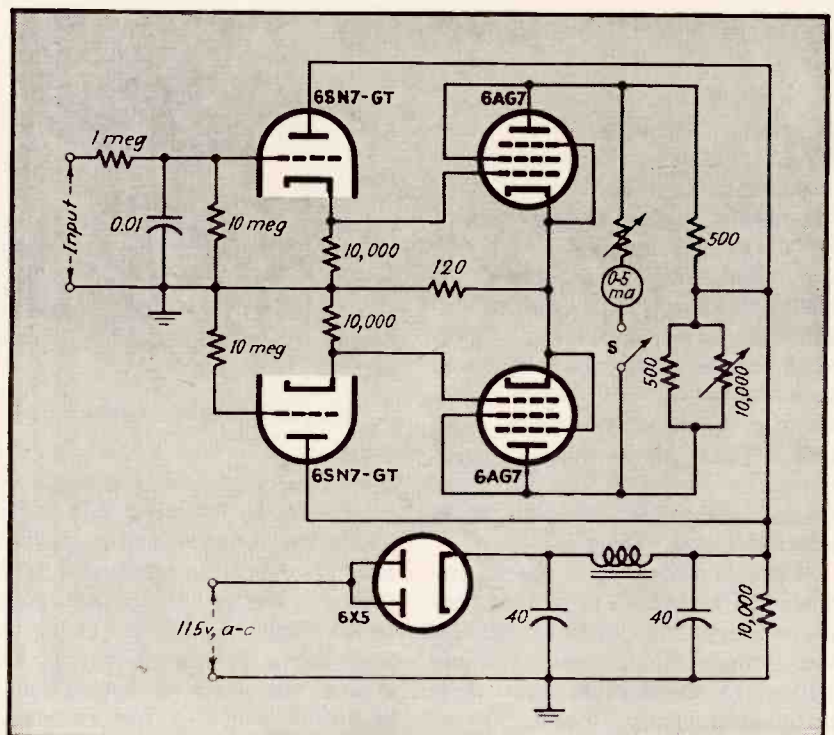

FIG. 2—Balanced voltmeter circuit uses cathode coupling and high-transconductance pentodes

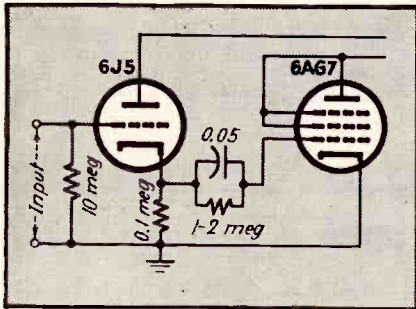

FIG. 3—Alternating-current vacuum-tube voltmeter with a cathode-coupled stage preceding the high-transconductance pentode grid-detector stage

6AG7's). At high plate current 50L6-GT tubes worked fairly well. A 6F8-G, with similar characteristics, might be preferable to the 6SN7-GT because higher input resistance could be obtained to the grid coming out of the top of the tube. It is possible that a selection of tubes with suitable heater ratings could be made in order to dispose of the filament transformer, to use cheaper tubes and to allow complete operation on a-c or d-c lines.

#### A-C Measurement

This type of circuit can easily be adapted to the measurement of a-c voltages. If  $R_1$  and  $C_1$  of Fig. 1 were removed, the insertion of a diode rectifier either before or after the first stage should work well and provide a linear scale. If placed after the first stage, the high input impedance of the circuit would be retained. An even simpler arrangement would be to allow rectification to take place in the first stage. This tube would then become what Rider<sup>3</sup> calls a reflex rectifier, or what radio publications often call an infinite-impedance detector.

In one adaptation to a-c that was tried, the grid circuit of the second stage was used as a rectifier, as illustrated in Fig. 3. With a 6AC7 tube, a deflection of 5 ma for 1-volt rms input is obtainable. The response is linear except over the very lowest part of the scale. Although this circuit was used only at audio frequencies, it has recently been shown by Daniels<sup>4</sup> that the cathode-follower circuit can be used up to several hundred kilocycles in

voltmeter circuits without using an external probe.

By using ordinary triodes in all four arms of a Wheatstone-bridge circuit, Glenn<sup>5</sup> has constructed a voltmeter which can operate a 1-ma instrument on less than 0.5 volt input. Stability and high input resistance are claimed along with this high sensitivity. Instruments of higher range are not suitable for this circuit because all tubes must be operated at very low plate currents in order to avoid a large grid current in the input tube.

#### Wheatstone Bridge

The circuit shown in Fig. 4 is similar to that of Glenn, but contains the added resistors  $R_1$  and  $R_2$ .

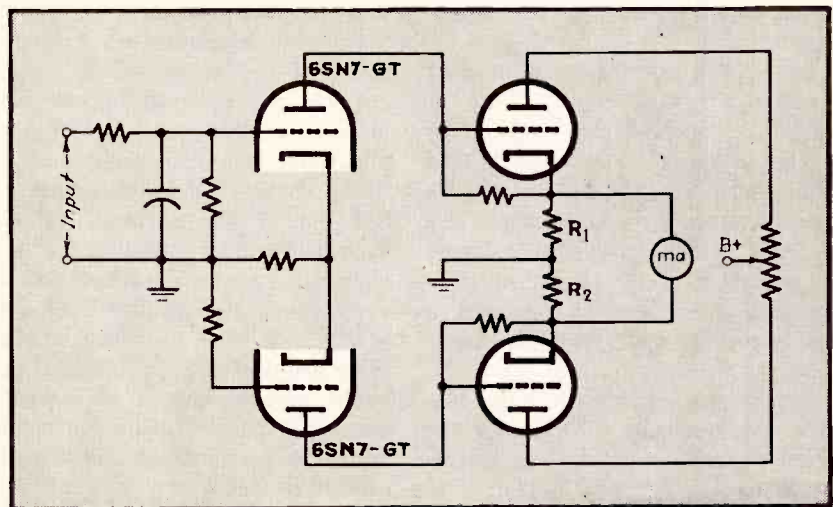

FIG. 4—Wheatstone-bridge balanced vacuum-tube voltmeter circuit combines high sensitivity and stability

The latter increase the power output greatly, especially when power tubes are used in the second stage. When tubes like 6V6-GT, 6L6 and 6AG7 are used at very conservative plate currents, a maximum deflection of 15 to 25 ma for 1.5 volts input is easy to obtain. Preliminary experiments have shown that the output can be made linear over the first 5 or 10 ma and that practical stability is possible. The use of separate resistors in the cathode circuits of the first stage is desirable.

#### Line-Voltage Compensation

Although balanced circuits like

those of Fig. 2 and Fig. 4 are advantageous, complete compensation for line-voltage fluctuations is not attained in them. The difficulty arises from slight differences in dynamic characteristics and in heater characteristics of similar tubes and should be more prominent in circuits like those shown above, especially when little or no degenerative feedback is used. However, it was found that power-line fluctuations in our laboratory caused a negligible error in reading when balanced circuits were used. For cases where these fluctuations are larger or where a more sensitive indicating instrument is to be used, greater stability could be obtained by using a stabilized power supply

or a constant-voltage transformer.

It can be expected in the above circuits that the calibration, depending more than usual upon tube characteristics, will change slightly as the tubes age. The inclusion of a Mallory bias cell in a voltmeter allows a frequent and rapid check upon this calibration.

#### REFERENCES

- (1) Turner, R. P., *Radio News*, p. 47, July, 1944.
- (2) Yard, E. M., *ELECTRONICS*, p. 160, July, 1944.
- (3) Rider, John F., "Vacuum Tube Voltmeters," John F. Rider Publisher, Inc., New York, 1941.
- (4) Daniels, H. L., *ELECTRONICS*, p. 125, Feb., 1945.
- (5) Glenn, H., *QST*, p. 35, Feb., 1945.

# Stabilized NEGATIVE

Negative impedance is produced from a positive impedance of the desired type by positive feedback through an amplifier stabilized with negative feedback. Basic circuits and fundamental equations indicate the regions and limits of stability for ideal conditions

By **E. L. GINZTON**

*Research Engineer  
Sperry Gyroscope Company, Inc.  
Garden City, N. Y.*

**I**NVERSE FEEDBACK is one of the most important developments in communication-network technique since the invention of the vacuum tube. Evolution of this principle can be traced along several independent courses two of which form the basis for this three-part article.

One of these courses culminated in Black's disclosure in 1934 of negative feedback by means of which amplifiers can be stabilized and improved in many ways. A somewhat earlier contribution was made by Aiken<sup>2</sup>, and Crisson<sup>3</sup> who discovered that by an appropriate application of positive feedback a two-terminal negative impedance could be obtained.

By combining the stabilizing feature described by Black and the negative-impedance concept introduced by Crisson and Aiken, it is possible to obtain a negative impedance that can be used as a stable

circuit element. Thus by adding negative resistance, negative capacitance, and negative inductance to the list of positive impedances, the engineer now has at his disposal six elements for design instead of the usual three, making possible not only an improvement in some of the present circuit applications, but also opening an entirely unknown field of design.

The first two parts of this article show how stabilized circuit elements can be obtained and investigate their stability and reliability. A few practical applications are described in the final part—not to give an air of completeness, but merely to illustrate some of the ways in which the negative circuit elements can be used.

A positive resistance  $R$  is defined by Ohm's law as the constant of

proportionality between the voltage across and the current flowing through that resistance. That is,  $R = E/I$  where  $E$  and  $I$  are voltage and current, respectively. According to Joule's law, power will be dissipated in resistance  $R$  at rate  $P$  where  $P = I^2R$ .

## Nature of Negative Resistance

From these two laws a definition of negative resistance may be formed. If  $R$  is replaced by  $-R_n$ , it will be seen that Ohm's law will still hold, for voltage and current will still be proportional to each other. Joule's law will state, however, that instead of dissipating power, the negative resistance will generate power, introducing it into the circuit at the rate  $I^2R_n$ .

Obviously, if any device is to show a negative-resistance characteristic, it must contain a source of power, such as a battery, and a means of controlling that power source so that Ohm's law will be followed. Since, in any practical case a source of power is limited, the negative-resistance characteristic will be shown by the device only over a limited range of voltage or current.

## Negative Reactances

The definition of negative inductance and negative capacitance may be formed analogously. The reactance of inductance  $X_L$  is defined by an extension of Ohm's law to alternating currents. Thus  $X_L = E_L/I = j\omega L$  where  $E_L$  is the voltage across the inductance,  $I$  is the current through the inductance, and  $L$  is the inductance in henrys. As is shown by this relation, a positive inductance is one whose re-

### PART I

Basic ideal circuit and fundamental equations for producing the negative of a positive impedance.  
Eq. (1)-(29), Fig. 1-9, Ref. 1-10

### PART II

Effect on negative impedance of variations with frequency of amplifier parameters.  
Eq. (30)-(56), Fig. 10-20, Ref. 11-13

### PART III

Illustrative applications of negative impedances show how improved circuits can be obtained.  
Eq. (57)-(67), Fig. 21-27, Ref. 14-16

# IMPEDANCES . . . Part I

actance increases with frequency.

If  $L$  is replaced by  $-L_n$ , the impedance is  $\omega L_n/j$ . This equation may be used as a definition of a negative inductance. Thus, it is seen that a negative inductance is equivalent to a capacitive reactance whose magnitude increases with frequency.

A negative capacitance may be defined in the same way. It will be found that a negative capacitance is equivalent to an inductance whose reactance decreases with frequency.

In passing, it should be noted that positive and negative inductances and positive and negative capacitances can store energy equally well. But in the case of the negative impedances, the amount of energy that can be stored is limited by the amount of voltage or current that the negative-impedance-producing element can supply.

Because amplifiers will be used to produce the negative impedances it will be necessary to consider their limits of linearity and power handling capacity. This consideration will be taken up in Part II; for the present we will assume that an amplifier which is linear within the range of operation required for the production of the required negative impedances can be built.

## Negative Resistance Sources

There are many sources of negative resistances known at present. Some of them occur in natural phenomena such as in gaseous discharges, others are produced by artificial means such as a source of energy and a control device arranged to maintain current and voltage in their required ratio.

An example of the latter is a direct-current series generator which shows a negative-resistance characteristic because current flowing through the generator excites its field and the generator produces a voltage which tends to increase the current.

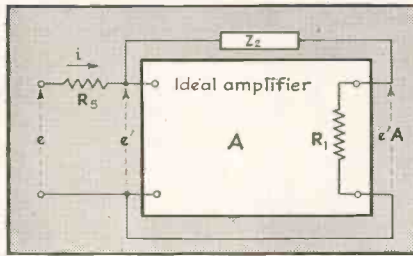

FIG. 1—Circuit for producing shunt negative impedance across its input terminals

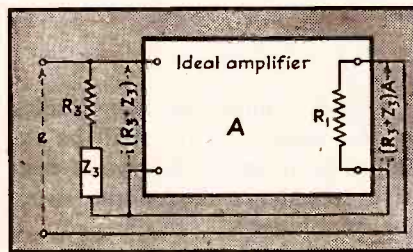

FIG. 2—Circuit for producing series negative impedance across its input terminals

Sources of negative resistance which are useful in communication circuits were described by Herold<sup>4</sup> and others. Some of these are: Arc discharge, the dynatron, retarding-field type of negative resistance<sup>5</sup>, a space-charge grid tube which operates with a temperature-limited cathode, the split anode magnetron, and a low gas-pressure triode.

None of these methods of obtaining negative resistances are capable of producing pure negative reactances. Moreover, examination of the various methods reveals that in most cases the resistance is not linear, but depends greatly upon the magnitude of the applied voltage or current.

A different method of obtaining negative circuit elements has been suggested by Crisson, Dudley, and Mathes by means of which it is possible to obtain linear negative resistances of any value whatever and also pure negative reactances. The following section will discuss the methods suggested by Crisson.<sup>6</sup>

There are two ways in which it is possible to obtain negative impedance provided a positive of this

impedance can be constructed in the form of a two-terminal network. The two methods can be used to produce the same impedance, but it will be found that only one of them can be used in any particular application. This consideration will be discussed in greater detail later.

First, equations will be determined for the input impedances of the two circuits which have been found to give negative impedances. This analysis will indicate the range and limiting factors of the negative impedances so produced.

## Shunt Negative Impedance

Consider the amplifier shown in Fig. 1. The square labelled  $A$  represents an ideal amplifier with a voltage amplification  $A$  and an output resistance  $R_1$ . (Output impedance  $R_1$  in this paper will mean the impedance looking into the output terminals of the amplifier. It is not necessarily equal to the physical output impedance of the amplifier because it may be affected by the presence of negative feedback in the amplifier.)

By an ideal amplifier is meant an amplifier which has a uniform frequency response from zero to infinity cycles per second, infinite power handling ability, zero phase shift for all frequencies, and an output resistance  $R_1$  which is independent of frequency.

Let

- $e$  = voltage applied to the amplifier
- $e'$  = voltage at the input terminals of the amplifier (see Fig. 1)
- $Z_2$  = any positive impedance, the negative of which it is desired to obtain
- $R_5$  = a resistance placed as shown in Fig. 1
- $i$  = current taken from the source of voltage  $e$

The circuit shown in Fig. 1 may be rearranged by means of Thévenin's theorem. If this is done, the output of the amplifier as shown in Fig. 1 may be replaced by the equivalent voltage  $e'A$  in series with the output resistance  $R_1$ . With

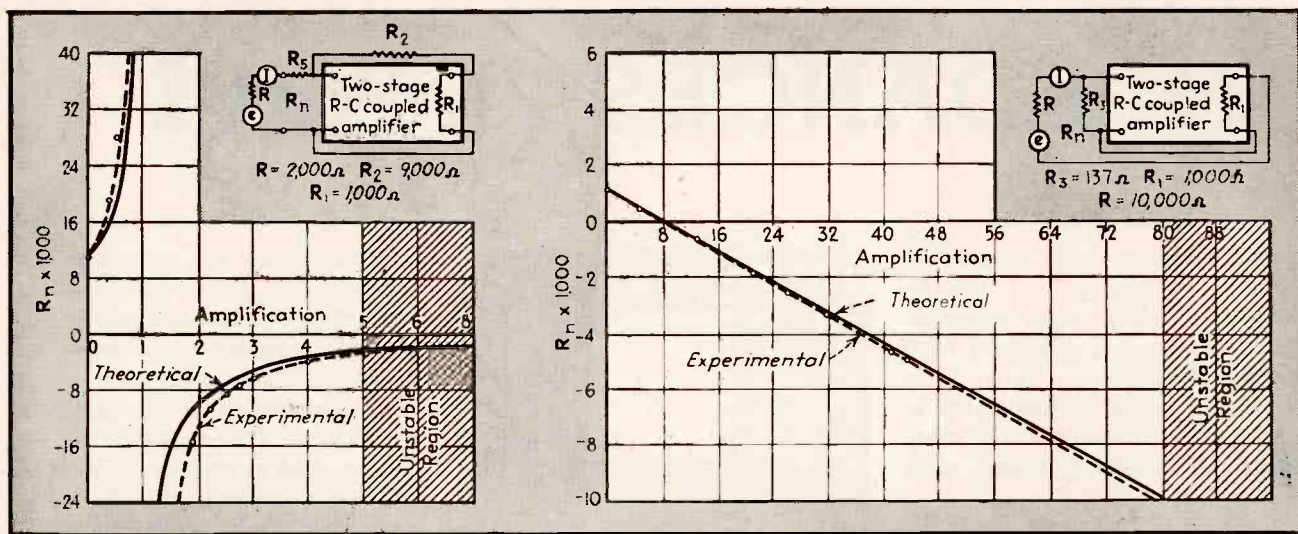

FIG. 3—Gain of amplifier determines magnitude and sign of negative resistance produced across its input although a single positive resistance is used

FIG. 4—A wide range of negative resistances can be produced by choice of amplification and of either shunt or series circuits

this transposition in mind, the following relations can be written. The net voltage acting across the output impedance  $R_1$  and impedance  $Z_2$  is  $(e' - e'A)$ , according to the convention of polarities of voltages indicated in Fig. 1 by means of arrows. Hence, the current that flows through  $R_1$  and  $Z_2$  in series is

$$i = \frac{e' - e'A}{Z_2 + R_1} = \frac{e'(1 - A)}{Z_2 + R_1} \quad (1)$$

Solving for  $e'/i$

$$\frac{e'}{i} = \frac{Z_2}{1 - A} + \frac{R_1}{1 - A} \quad (2)$$

This ratio represents an impedance at the amplifier terminals where  $e'$  is measured. The impedance offered to the source of voltage  $e$  must be the sum of  $R_s$  and this apparent amplifier input impedance. Defining the impedance offered to the source  $e$  by the entire circuit as  $Z_n$ ,

$$Z_n = e/i = R_s + e'/i \quad (3)$$

$$Z_n = R_s + \frac{Z_2}{1 - A} + \frac{R_1}{1 - A}$$

If  $R_s$  is adjusted so that  $R_s = R_1/(A - 1)$ , then  $R_s + R_1/(1 - A) = 0$ , and therefore Eq. (3) becomes

$$Z_n = Z_2/(1 - A) \quad (4)$$

If the amplification  $A$  is positive and greater than unity, then the input impedance of the circuit of Fig. 1 is negative and determined in character only by the nature of  $Z_2$ . Crisson attributes this type of

a negative impedance to Dudley and for reasons which will be explained later calls this type of negative impedance the *shunt negative impedance*.

#### Series Negative Impedance

The second method of obtaining negative impedance is illustrated in Fig. 2. In this case  $Z_3$  is the positive impedance the negative of which is the desired result.  $R_s$  is a resistance whose function is similar to that of  $R_s$  in the previous case.

If  $e$  is the voltage applied at the terminals of the circuit as is shown in Fig. 2, then a current  $i$  will flow through the circuit. The following equation can be written.

$$e = i(R_s + Z_3 + R_1) - i(R_s + Z_2)A \quad (5)$$

From which

$$Z_n = (e/i) = Z_3(1 - A) + \frac{R_1}{R_s(1 - A) + R_1} \quad (6)$$

If  $R_s$  is adjusted so that  $R_s = R_1/(A - 1)$ , then  $R_s + R_1/(1 - A) = 0$ , and therefore

$$Z_n = Z_3(1 - A) \quad (7)$$

If  $A$  is positive and greater than unity, the input impedance of the circuit is negative and determined in character only by the nature of  $Z_3$ . This type of a negative impedance is called a *series negative impedance*. Crisson attributes its discovery to Mathes.

From the preceding discussion it

is evident that by means of application of positive feedback in an ideal amplifier it is possible to obtain negative impedances without depending upon natural phenomenon such as gas discharge or secondary emission, or upon a device which may be inherently nonlinear.

#### Reliability

The elementary picture given above is not sufficient for a practical application of negative impedances. One can readily observe that both of these circuits are essentially members of the same family and involve positive feedback, and one would be rightly justified in raising the question of stability and how the deviations from the assumed ideal amplifier will affect its performance. These questions will be discussed later where it will be shown that negative circuit elements can be made to possess extraordinary stability, and that the deviations of an actual amplifier from the ideal modify the results only in special regions.

In addition to the positive feedback that is obviously necessary to obtain the negative impedances, the amplifiers themselves can be stabilized with negative feedback. It will be shown that simultaneous application of positive and negative feedback in an amplifier may be made use of to produce negative impedances which are just as sta-



ble and reliable as ordinary commercially available circuit elements. Nor in this simultaneous application of positive and negative feedback does the effect of one cancel the effect of the other. Amplifier gain does, however, play a major part in determining the magnitude and stability of negative impedance. The effect is different for negative impedances produced by the two methods, as the following considerations will show.

#### Amplifier Gain in Shunt Circuits

If the amplification in Fig. 1 is zero, the input impedance offered to the source of a voltage  $e$  is the sum  $(R_s + Z_s + R_i)$ , and the current flows from the source of voltage, being entirely determined by this sum. If  $A$  is increased positively from zero towards infinity, the current will decrease and when  $A$  is of such a magnitude that the output voltage of the amplifier just equals  $e$ , the current must be zero and therefore the input impedance  $Z_n$  must be infinite. This is also observed from Eq. (3) and (4), because when  $A = 1$ ,  $Z_n$  becomes infinite.

If  $A$  becomes greater than unity, the current reverses and flows into the source of voltage  $e$  and the circuit exhibits negative impedance characteristics. When  $A$  reaches a value so that the resultant current flowing into the voltage source  $e$  supplies all the losses in its path, oscillations will result.

An example of this kind of a negative impedance is illustrated in Fig. 3, where  $Z_s$  was chosen to be a pure resistance so that the input impedance of the amplifier is a pure negative resistance. The shaded region indicates the values of  $A$  for which the amplifier is unstable and in which case current is limited only by the power handling ability of the amplifier. It is seen from Fig. 3 that the negative resistance supplied by the amplifier in the stable region is greater in magnitude than the resistance  $R$  in parallel with which it is connected, and approaches an open circuit.

It should be observed at this point that a combination of a positive resistance in parallel with a larger negative resistance results in a positive resistance, although

the series combination of the same two resistances will result in a negative resistance.

From interpretation of the performance of the circuit it was found that the arrangement of Fig. 3 is stable as long as the negative resistance supplied by the amplifier is greater than the positive resistance across which it is connected, i.e., in the region where the parallel combination of the two is positive. Because of this phenomenon, the type of the negative impedance supplied by the arrangements shown in Figs. 1 and 3 is called a shunt negative impedance.

#### Amplifier Gain in Series Circuits

The situation in the case of Fig. 2 will be found to be different. If the amplification is zero, then the input impedance of the amplifier consists of the sum  $(R_s + Z_s + R_i)$ . As  $A$  is increased from zero to unity, the voltage developed across the output terminals of the amplifier will be of such a direction that it will aid the applied voltage and the current will increase. When  $A = 1$ , the input voltage just equals the output voltage, and the voltage drop across the entire arrangement will be zero, which corresponds to zero input impedance. The current at this point will be limited entirely by the internal impedance of the source of voltage  $e$ .

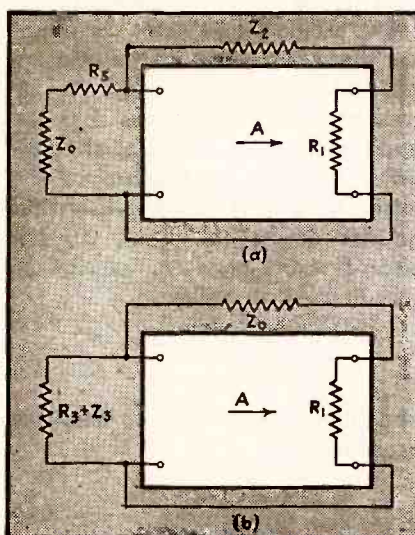

FIG. 5—Rearrangement of Fig. 1 and 2 shows that both shunt and series negative impedance are obtained from the same basic circuit. (a) corresponds to Fig. 1. (b) to Fig. 2

If  $A$  is larger than 1, there will be a negative drop across the amplifier and its input impedance will be negative as defined by Eq. (6) and (7). If  $A$  is increased to the point where the current is so large that it supplies all the losses in its path, instability will be reached. As is shown in the special case illustrated in Fig. 4, the current for a constant voltage will continuously increase, from a value determined by  $(R_s + R_i + Z_s)$  when  $A = 0$  to infinity when all the losses are supplied by the amplifier.

As is clearly evident from these considerations and Fig. 4, the negative impedance will be stable and finite as long as its value is smaller in magnitude than the impedance in series with which it is connected. Thus, in the stable region of operation, the series combination of positive and negative impedance is positive, and for this reason, this type of a negative impedance is called a series negative impedance.

#### Negative-Impedance Limits

From this discussion it is evident that across a given positive resistance any value of negative resistance may be placed, from zero to infinity, and providing the negative resistance is of the right kind (shunt or series), a stable result will be obtained. It is plain that the ordinary concept of resistance is incomplete; a prediction regarding the behavior of the combination of positive and negative impedances cannot be made without complete information regarding the method used to supply the negative element. A more complete, but not any more rigorous, discussion will be found in the literature.<sup>3, 4, 6</sup>

In Fig. 1 and 2 resistances  $R_s$  and  $R_i$  are not essential parts of the negative impedances and Eq. (3) and (6) show that negative impedances will result whether these two resistances are present or not. However, due to the finite magnitude of the output impedance of the amplifier the negative impedance obtained by means of the amplifier alone will contain a term which is due to the output impedance of the amplifier. By placing proper positive resistances in series with the negative impedance the resistive component of this term will be can-

celled and a pure negative impedance can be obtained. In the case of an ideal amplifier this cancellation can always be done; in the discussion which follows, it will be invariably assumed to have been done. Errors due to this assumption in the case of an actual amplifier will be discussed and analysed in Part II.

### Stability

Before launching into the discussion itself, the particular sense in which the terms are used will be defined.

Conventional technical terminology is often confusing, the word stability having more than one meaning. In this paper there are discussed two kinds of stability and, although somewhat related, their meanings are different.

Operation of an amplifier is generally termed stable if introduction of an infinitesimal voltage anywhere in the amplifier will result in a transient which will decrease with time. If, on the other hand, the introduction of such voltage will produce currents which will increase indefinitely with time (or until limited by saturation of some element), operation of the amplifier is said to be unstable but in this paper such a result will be termed oscillation.

The second type of stability will be defined by the word stability itself, and will refer to the amount that the negative impedance can change due to a small variation in amplification of the amplifier, as for example by power supply voltage variation.

### Conditions for Oscillation

Because positive feedback around an amplifier is used to produce negative impedance, it is to be expected that oscillation will occur for some conditions; in fact the previous qualitative examination of the effect of amplifier gain indicated, that for large amplification, oscillation does take place; therefore a more rigorous analysis of the conditions for oscillation will be made.

Figures 5(a) and 5(b) are rearranged forms of schematic circuits shown in Fig. 1 and 2 in which  $Z_0$  is the internal impedance of the

source  $e$ . From these it is seen that the actual circuits which develop negative impedances are identical in character, the difference being merely in the two points across which the desired negative impedance is developed.

On the basis of the criterion given by Nyquist' the possibility of oscillation may be determined by considering the circuits as positive-feedback circuits in which the impedance  $Z_0$  is the impedance which is actually used across the terminals of the negative impedance. In

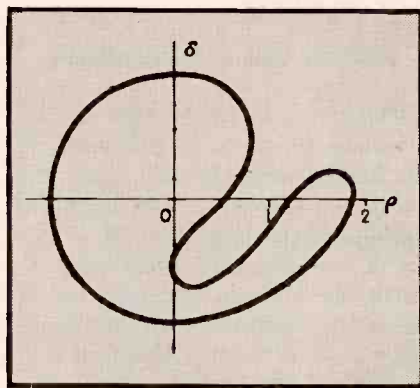

FIG. 6—Oscillations can not occur unless point (1, 0) of the Nyquist diagram is enclosed by the feedback-factor curve

general, it is impossible to predict whether oscillation will or will not occur except by applying Nyquist's criterion. In simple cases, however, it is possible to examine the circuits in the following manner.

The oscillations cannot occur unless there is a value of the positive feedback factor  $\alpha A$  equal to or greater than unity, where  $A$  is the amplification parameter of the amplifier and  $\alpha$  is the fraction of the output voltage of the amplifier that appears across its input. In the case of shunt negative impedance,  $\alpha$  is defined as follows

$$\alpha = \frac{R_1 + Z_0}{Z_0 + R_1 + Z_2} \quad (8)$$

And in the case of series negative impedance

$$\alpha = \frac{R_1 + Z_1}{Z_0 + R_1 + Z_2} \quad (9)$$

The positive-feedback factor  $\alpha A$  is a complex number and is a function of frequency in a way which is determined by the type of amplifier

used and the character of the feedback network. It can be divided into a real and an imaginary part  $\alpha A = \rho + j\delta$ .

A not sufficient but a necessary condition for oscillation is that  $\delta = 0$ . There may be several frequencies at which this condition is satisfied, say, at  $f_1, f_2, f_3, \dots, f_n$ . If the real part of  $\alpha A$  at any one of these frequencies exceeds unity, then oscillations will exist. Hence, the condition for oscillation may be stated as

$$\rho(f_1, f_2, f_3, \dots, f_n) \geq 1 \\ \delta = 0$$

The one possible but unusual and seldom met exception to this rule may occur as is shown in Fig. 6 where, according to Nyquist's criterion, oscillations cannot occur. On the other hand, if the smallest value of  $\rho(f_1, f_2, f_3, \dots, f_n)$  is greater than unity, then re-entrant curves around the point ( $\rho = 1, \delta = 0$ ) are impossible and oscillations will necessarily exist. This is by far the most usual case.

If, for instance, the source impedance  $Z_0$  is zero in the case of the series negative impedance, then according to Eq (9)  $\alpha = 1$  and  $\alpha A = 1$ . In the ideal amplifier (or in a practical one at the point where the phase shift is zero)  $A$  is a real constant so that  $\delta = 0$ . If  $A$  is greater than unity, then oscillations must occur. In the case of a shunt negative impedance, if the source impedance  $Z_0$  is made infinite, then  $\alpha A = 1$  and oscillations must occur. This is seen to be in agreement with the physical interpretation of the negative impedance previously described.

### Stabilization of Negative Impedances

Behavior of the negative impedance obtained in the manner illustrated in Fig. 1 and 2 depends only upon two factors, namely, the amplifier and the positive impedance. The positive impedances  $Z_1$  and  $Z_2$  are ordinary impedances constructed from resistors, inductors, and capacitors. The resultant negative impedance will obviously possess all the characteristics of these elements such as impedance change with temperature or with the amount of current or voltage applied to them. But in addition to these, the negative impedance is

More often than not, the **MULTI-PRONG PLUG CONNECTOR** in service is a Cinch



## "it's KNOW HOW"

For years, in various combinations of one or more contacts, Cinch has supplied connectors of the general type illustrated. In War or Post War the full floating feature of the contact permits an easy action positive connection. You need only state your particular Engineering requirements...we have it developed and ready for use. These chassis multi-prong plug connectors are also made in a cable terminal metal shield type.



No. 3703

ACTUAL SIZE



No. 3834



# CINCH

**MANUFACTURING CORPORATION**  
2335 W. Van Buren St. Chicago 12, Ill.

Subsidiary of United-Carr Fastener Corporation,  
Cambridge, Mass.

\*The new Cinch Catalog, 140 pages describing  
metal parts and metal plastic assemblies

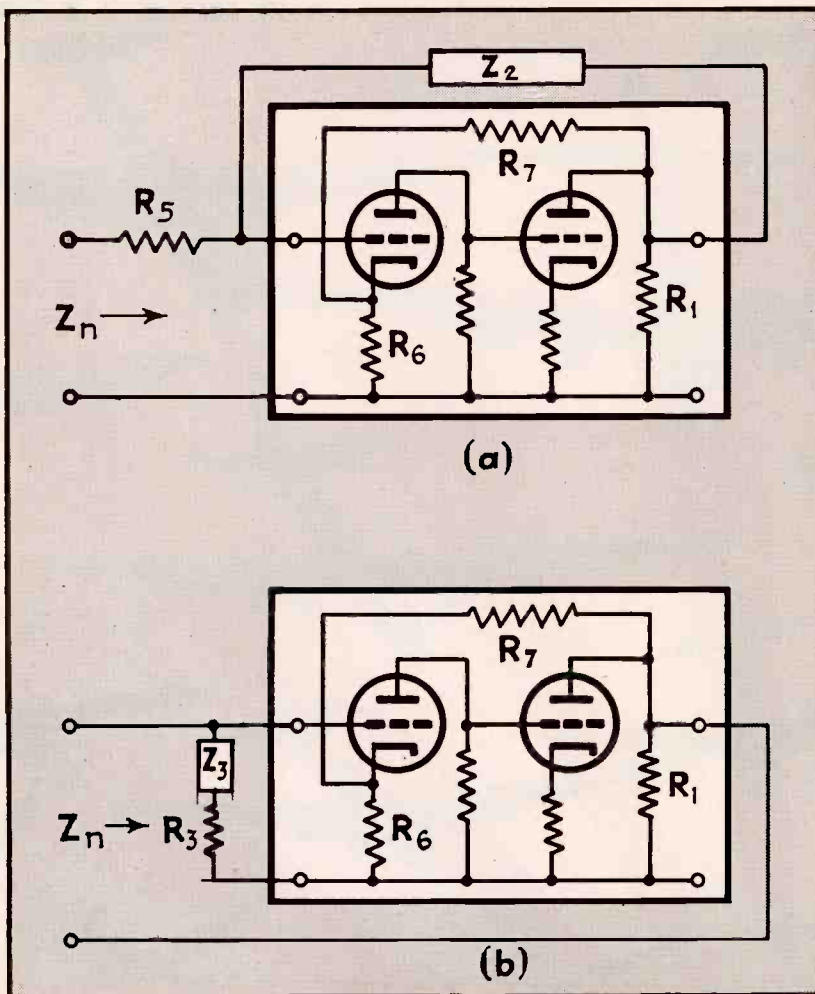

FIG. 7.—Feedback to stabilize amplifiers used to produce negative impedance is produced by  $R_6$  and  $R_7$  at (a) for shunt and at (b) for series negative impedance

also dependent upon the gain of the amplifier used to supply that negative impedance.

In ordinary amplifiers the amplification often changes because of voltage fluctuations of the power supplies. Slow changes in tube characteristics and aging of the components of the amplifier also produce slow variations in the gain of the amplifier, and these, of course, will change the magnitude of the negative impedances. However, all of these factors may be greatly reduced by sufficient negative feedback within the amplifier itself. As will be shown later, the characteristics of the negative impedance can be easily made dependent, not upon the properties of the amplifier that supplies it, but upon the variations of the positive impedances  $Z_2$  and  $Z_3$  in the way mentioned previously.

The stabilization of the ampli-

fier that supplies the negative impedances is well known and does not need to be fully described here.<sup>1, 5, 9, 10</sup> Important properties of stabilized amplifiers of particular interest in connection with the negative impedances will be taken up in Part II. Simplified diagrams of possible ways in which feedback can be applied to amplifiers supplying negative impedances are shown in Fig. 7(a) and 7(b).

#### Effect of Negative Feedback

The amplifier shown in both cases is a two-stage amplifier with all sources of power and filter network omitted for the sake of simplicity. A two-stage amplifier is necessary because the output and the input must be of the same relative polarity. A fraction  $\beta$  where  $\beta = R_6/(R_6 + R_7)$  of the output voltage of the amplifier is returned to its input in such a manner that

negative feedback is developed in the amplifier and its gain is stabilized by the factor  $A\beta$ , where  $A$  is the amplification of the amplifier with all feedback networks omitted. Except for the introduction of negative feedback, these circuits will be found to be the same as the schematic representations shown in Fig. 1 and 2.

The negative impedance developed by the amplifiers shown in Fig. 7 may be found in the same manner as in Eq. (4) and (7) if

$$\begin{aligned} A &= \text{amplification of the amplifier without negative feedback} \\ \beta &= \text{fraction of the output voltage returned to the input of the amplifier as negative feedback} \\ G &= \text{gain with negative feedback} \\ G &= A/(1 - A\beta) \end{aligned} \quad (10)$$

and  $R_3$  and  $R_5$ , so adjusted that

$$R_3 = R_1/(G - 1) \quad (11)$$

$$R_5 = R_1/(G - 1) \quad (12)$$

then, the shunt negative impedance will be given by

$$Z_n = Z_2/(1 - G) \quad (13)$$

and the series negative impedance by

$$Z_n = Z_3(1 - G) \quad (14)$$

In the material that is to follow, it will be assumed that  $R_3$  and  $R_5$  are so adjusted that Eq. (11) and (12) hold and Eq. (13) and (14) will be used with this implication in mind. For the sake of simplicity, all diagrams shown from this point on will not show resistances  $R_3$  and  $R_5$ , although their presence is implied in all cases where a pure negative impedance is desired.

#### Stability of Negative Impedances

At first sight it may be thought that simultaneous application of positive and negative feedback in the same amplifier will simply produce cancellation, and if equal feedback factors are used the result would be the same as if no feedback were used at all. However, this is not so, as will become apparent as the discussion progresses.

As was seen in the above derivations and discussions, circuits shown in Fig. 1 and 2 produce negative impedances. By application of negative feedback internally to the amplifier its gain may be stabilized in the conventional manner. The extent to which the negative feedback stabilizes the negative imped-



## ENGINEERING BACKGROUND

*A Traditional Quality of Mallory Contacts*

WITH 22 years of engineering experience in developing improved alloys and materials for contact applications—in designing all types of contacts and contact assemblies—and manufacturing them with precision—Mallory is ready to supply electrical contacts or contact assemblies with the extra measure of quality that assures improved performance in your equipment. During this period, over 5,000 designs have been developed by Mallory engineers to establish a wealth of contact “know how.”

The *design* best adapted to your contact application is manufactured by Mallory from the most suitable *materials* . . . for

Mallory provides contacts of tungsten, silver, platinum, Elkonite\*, Elkonium\* and other Mallory alloys in various combinations. Whether you want complete contact assemblies, individual contacts, or contacts attached to brackets, springs, studs, or arms Mallory has the facilities for a large production run or a small order.

Manufacturers of relays, industrial controls, circuit breakers, business machines, home appliances and other electrical and electronic equipment rely on Mallory—Contact Headquarters. Make it a policy to consult Mallory engineers *before* your designs are blueprinted.

P. R. MALLORY & CO., Inc., INDIANAPOLIS 6, INDIANA



\*Reg. U. S. Pat. Off. for electric contacting elements.

P. R. MALLORY & CO., Inc.

# MALLORY

**ELECTRICAL CONTACTS AND CONTACT ASSEMBLIES**

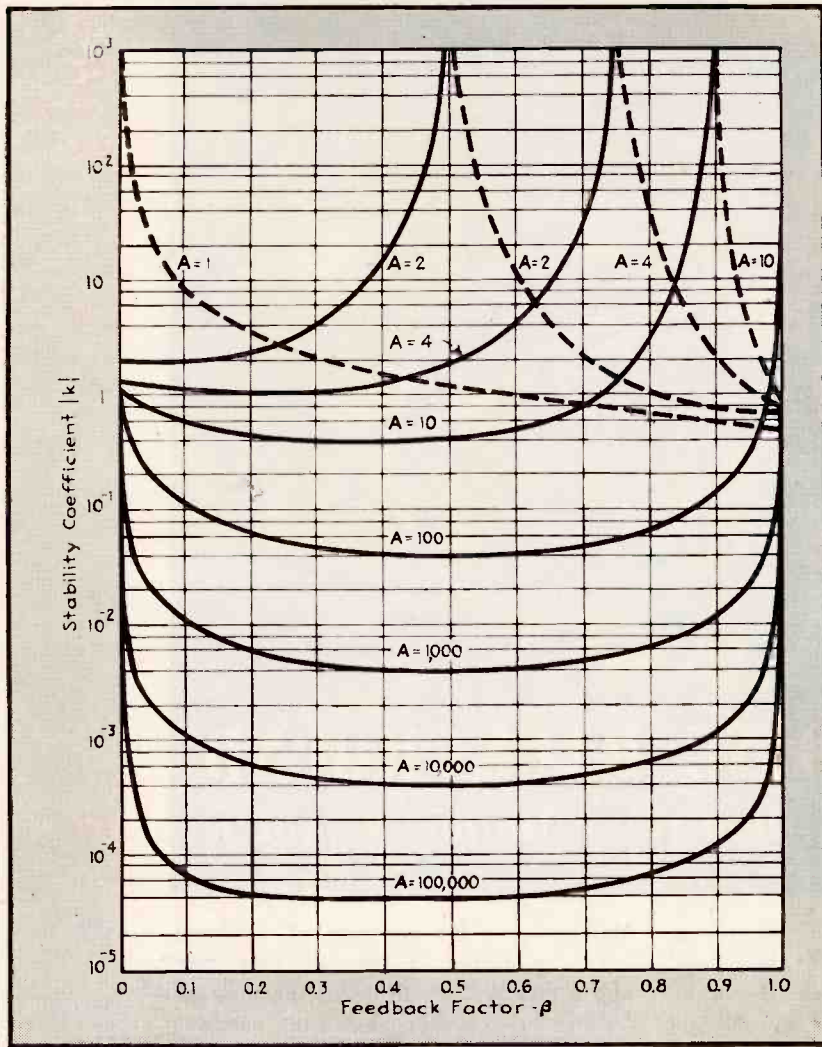

FIG. 8—Stability coefficient as a function of amplification and negative feedback shows regions in which best stability of negative impedance can be obtained

ances will now be determined quantitatively.

Stability of a negative impedance may be defined as the fractional change in negative impedance produced by a small change in gain of the amplifier which supplies that negative impedance. Stated algebraically  $\frac{\partial Z_n}{Z_n} = k \frac{\partial A}{A}$  where  $A$  is the gain of the amplifier,  $\partial A$  is a small change in the gain,  $\partial Z_n$  is the change in the negative impedance, and  $k$  is a coefficient of stability, obviously dependent upon the amount of negative feedback utilized in the amplifier.

The coefficient of stability  $k$  describes to what extent negative impedance is affected by small changes in the propagation parameter of the amplifier. The ideal case would be obtained if  $k$  were zero, i.e., when a small change in the propa-

gation parameter of the amplifier would produce no change in negative impedance.

As will be seen presently, stability of the shunt and series negative impedance is different, and the analyses will be divided into separate parts.

#### Stability of Shunt Negative Impedance

The shunt negative impedance is dependent upon the gain of the amplifier in the way expressed by Eq. (13). Substituting the value of  $G$  given by Eq. (10) in Eq. (13) one obtains for negative impedance the expression

$$Z_n = Z_2 \frac{1 - A\beta}{1 - A\beta - A} \quad (15)$$

The stability coefficient may be obtained from this expression by differentiating with respect to  $A$  giving change in  $Z_n$  to change in  $A$

$$\begin{aligned} \frac{\partial Z_n}{\partial A} &= Z_2 \frac{\beta(A\beta + A - 1) + (1 - A\beta)(\beta + 1)}{(1 - A\beta - A)^2} \\ &= Z_2 \frac{1}{(1 - A\beta - A)^2} \end{aligned} \quad (16)$$

and therefore

$$\frac{\partial Z_n}{Z_n} = \frac{\partial A}{(1 - A\beta - A)(1 - A\beta)} \quad (17)$$

From which, the stability coefficient may be recognized as

$$k = \frac{A}{(1 - A\beta - A)(1 - A\beta)} \quad (18)$$

This important relation states that shunt negative impedance is stabilized by a factor which does not contain  $Z_n$  and hence, the stability of shunt negative impedance is independent of its magnitude.

Investigation of the properties of the stability coefficient shows that there is an optimum value of  $\beta$  for any given value of  $A$ . The best value of  $\beta$  may be obtained by maximizing Eq. (18) with respect to  $\beta$ , as follows

$$\frac{\partial k}{\partial \beta} = \frac{A(1 - A\beta - A)A + (1 - A\beta)A}{(1 - A\beta - A)^2(1 - A\beta)^2} = 0 \quad (19)$$

Solving this for  $\beta$

$$\beta_{opt} = \frac{1}{2} \left( \frac{2}{A} - 1 \right) \quad (20)$$

from which the optimum value of  $\beta$  for any given value of  $A$  may be obtained. The stability coefficient at  $\beta_{opt}$  is

$$k_{opt} = -4/A \quad (21)$$

Another critical point occurs when the denominator of Eq. (18) becomes zero, i.e., when  $(1 - A\beta - A) = 0$ . This is the case when

$$\beta = (1 - A)/A \quad (22)$$

At this value of  $\beta$  the stability coefficient is infinite and a small change in gain would produce an infinite change in the negative impedance. However, at this value of  $\beta$  the gain of the amplifier is unity

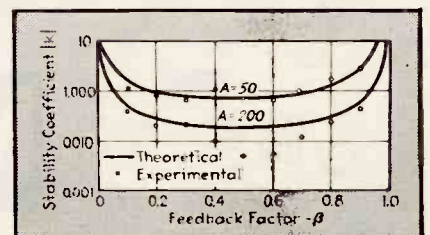
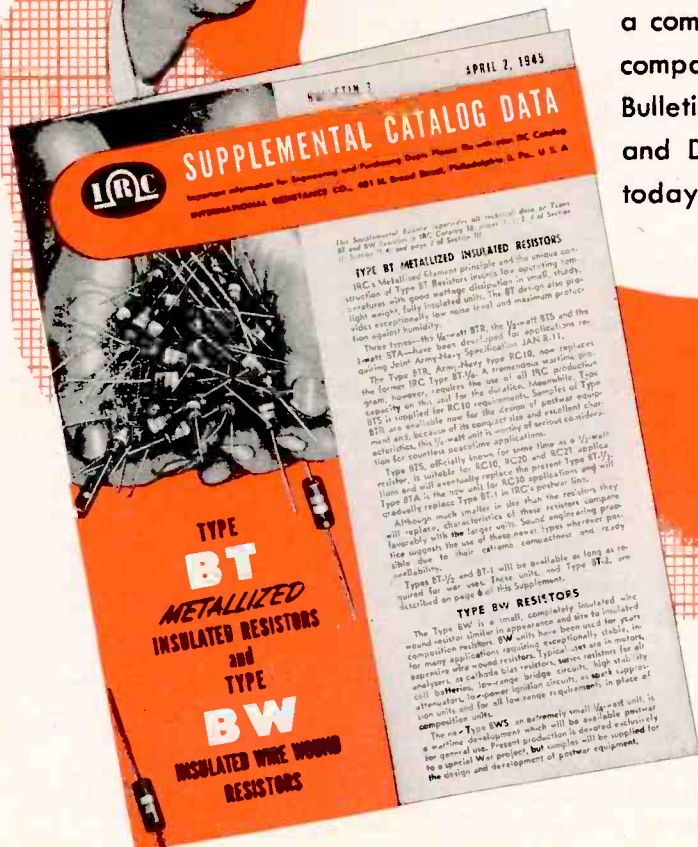

FIG. 9—Experimental determination of stability verifies the theoretical predictions

# READ THE LATEST NEWS!...

## About **IRC** Type **BT** and **BW** RESISTORS

Here's a brand new file size Engineering Bulletin, just off the press! It offers you essential authentic information on IRC Type BT (Insulated Metallized) and BW (Insulated Wire Wound) Resistors. Concise, easy-to-read and an excellent ready-reference source, it contains eight pages of "meaty" material that will save you valuable time by quickly answering many of your resistance problems. Interesting construction facts, characteristics data, JAN Type Numbers, dimensional drawings, as well as a complete list of resistance values are compactly presented in this new BT-BW Bulletin. It should be in every Engineering and Design file. Write for your copy today. Address Dept. 1-G



# INTERNATIONAL RESISTANCE CO.

401 N. Broad St. Phila. 8, Pa.

IRC makes more types of resistance units, in more shapes, for more applications than any other manufacturer in the world.

and the negative impedance is infinite and obviously this critical point is of no importance.

### Stability Calculations

Figures 8 and 9 show Eq. (18) in graphical form as a function of  $A$  and  $\beta$ . From Fig. 8 it is seen that the larger the propagation constant of the amplifier, the better the stability of the shunt negative impedance. If  $A$  is very large, then  $\beta = -0.5$  gives the best  $k$ , but there is little improvement beyond  $\beta > 0.1$  and in all practical cases this is the most satisfactory value due to the difficulty of obtaining a high value of  $A$  and a higher value of  $\beta$  than 0.1 due to the shunting effects of the  $\beta$  network.

With present day tubes it is easy to obtain an amplification of 10,000. If enough negative feedback in the amplifier is used to make  $\beta = -0.1$ , then, according to Eq. (18) or Fig. 8, the stability coefficient is nearly  $10^{-3}$ .

A test of a simple amplifier has shown that a 20 percent change in the supply voltage of a typical amplifier produced an 8 percent change in amplification. Hence, the change in the negative impedance supplied by this amplifier would be in the neighborhood of eight parts in 100,000. This stability is better than that encountered with ordinary circuit elements in cases where no temperature compensation is provided.

### Stability of Series Negative Impedance

Effects of small changes in amplification of the amplifier which supplies the series negative impedance may be obtained in a similar manner. Series negative impedance is dependent upon the gain of the amplifier as given by Eq. (12) and (14). Combining this with the Eq. (10) which takes into account the negative feedback in the amplifier

$$Z_n = Z_s' \left( \frac{1 - A\beta - A}{1 - A\beta} \right) + R_1 \quad (23)$$

where  $Z_s' = Z_s + R_3$

From this, the stability coefficient may be obtained by differentiation

$$\frac{\partial Z_n}{Z_n} = \frac{-\partial A}{(1 - A\beta) \{ (1 - A\beta) [(R_1/Z_s') + 1] - A \}} \quad (24)$$

The stability coefficient is

$$k = \frac{-A}{(1 - A\beta) \{ (1 - A\beta) [(R_1/Z_s') + 1] - A \}} \quad (25)$$

This relation is different from the corresponding one for the shunt negative impedance because it involves the terms  $Z_s'$ , which means that the stability of a series negative impedance depends upon the magnitude of the negative impedance developed by the amplifier. A physical interpretation of this dependence may be seen by examining two boundary cases.

If the output impedance of the amplifier  $R_1 \ll Z_s'$ , then the stability coefficient becomes very much the same as the one in the shunt negative impedance. If  $Z_s' = R_1 / (G-1)$ , the second bracket in the denominator of Eq. (25) reduces to zero. In this case, the stability coefficient becomes infinite. This latter case is of not much practical importance, for it corresponds to zero series negative impedance offered by the amplifier. In a practical amplifier, the output impedance of the amplifier can be made small, and for any given value of the negative impedance, the stability coefficient may be made as small as is desired by increasing  $A$  sufficiently. Rewriting Eq. (25) shows this more clearly

$$k = \frac{-1}{(1 - A\beta) [1 - (1 - A\beta)/A] [(R_1/Z_s') - 1]} \quad (26)$$

If  $A$  is made very large, then

$$k \approx \frac{1}{A\beta [1 + \beta] [(R_1/Z_s') - 1]} \quad (27)$$

and the stability can be made as good as desired by making  $A$  large enough.

For any given value of  $R_1/R_3'$  and  $A$  there is a best value of  $\beta$ . This critical value may be obtained by maximizing  $k$  as given by Eq. (25) with respect to  $\beta$ . This leads to the result.

$$\beta_{opt} = -\frac{1}{2} (1 - 4R_3/AZ_s') \quad (28)$$

This again differs from the best value of  $\beta$  in the shunt negative impedance as given by Eq. (22) because Eq. (28) involves the factor  $R_3/Z_s'$ , i.e., it depends upon the value of the negative impedance developed by the amplifier. The stability coefficient for the series negative impedance at the best value of  $\beta$  is obtained

by combining Eq. (28) with Eq. (25) or (26). This gives

$$k_{opt} = -\frac{4}{A} \frac{1}{[(2R_3/Z_s')^2 - 1] [(R_3/Z_s') - 1]} \quad (29)$$

which differs from the optimum value of the stability coefficient in the case of shunt negative impedance in the same general manner discussed above in connection with Eqs. (25) to (28).

### Most Stable Condition

It is interesting to notice that if  $R_3/Z_s' \ll 1$ , then the optimum value of  $\beta$  in the case of the series negative impedance is  $-\frac{1}{2}$ . This is also true (exactly so, however) in the case of the shunt negative impedance. Remembering the fact that the gain of the negative-feedback amplifier approximates  $-1/\beta$  it is seen that if the optimum value of feedback is used for best stability, the gain of the amplifier supplying negative impedance is just equal to 2. Hence, from Eq. (13) and (14) it is seen that the negative impedances developed by the amplifier in the two possible manners are

$$\begin{aligned} \text{shunt type } Z_n &= -Z_2 \\ \text{series type } Z_n &= -Z_3 \end{aligned}$$

In other words, if the most stable operation of the negative impedance is desired, the value of the negative impedances obtained are merely the negative values of the positive impedances  $Z_2$  and  $Z_3$ .

### REFERENCES

- (1) Black, H. S., Stabilized Feedback Amplifiers, *A.I.E.E. Trans.*, 53, No. 1, p. 114-120, Jan. 1934.
- (2) Aiken, C. B., The Alteration of Resistance, Inductance, and Capacity by Means of Resistance Coupled Amplifiers, *Jour. Optical Soc. of America*, 15, p. 85-95.
- (3) Crisson, G., Negative Impedances and the Twin 21-Type Repeater, *B. S. T. Jour.*, 10, p. 485-513, July 1931.
- (4) Herold, E. W., Negative Resistance and Devices for Obtaining It, *Proc. I. R. E.*, 23, No. 10, p. 1201-1223, Oct. 1935.
- (5) Brunetti, C., The Transitron Oscillator, *Proc. I. R. E.*, 27, No. 2, p. 88-94, Feb. 1939.
- (6) Steimel, K., Stability and Self Oscillation of Electric Circuits, *Zeit. fur Hochfrequenz*, 36, p. 161, 1930.
- (7) Nyquist, H., Regeneration Theory, *B. S. T. Jour.*, 11, p. 126-147, July 1932 (This is a theoretical paper experimental verification of which is contained in a paper by Peterson, Kreer, and Ware, Regeneration Theory and Practice, *Proc. I. R. E.*, Oct. 1934).
- (8) Terman, F. E., Negative-Feedback Amplifiers, *ELECTRONICS*, Jan. 1937.
- (9) Cocking, W. T., Negative Feedback Amplifiers, *Wireless World*, Nov. 6, Nov. 13, and Dec. 25, 1936.
- (10) Terman, F. E., and Wen-Yuan Pan, Frequency Response Characteristics of Amplifiers Employing Negative Feedback, *Communications*, March 1939.



# HARVEY 206 PA

*A Two-Range Source  
of Laboratory D.C. Power*

The HARVEY Regulated Power Supply 206 PA is the latest contribution to the radio and electronics industries by HARVEY of CAMBRIDGE. It is designed to fill the need for a constant source of laboratory D.C. power between the ranges of 500 to 1000 volts.

The HARVEY 206 PA operates in *two ranges*:  
*Low range* — 500 to 700 volts at  $\frac{1}{4}$  amp. . . . *High range* — 700 to 1000 volts at  $\frac{1}{5}$  amp. . . . Regulation is 1% or better . . . Output is constant even though line voltage varies between 95 and 130 volts . . . Output is constant within 1% from no load to full load in each range.

These important factors plus many other safety and convenience features make the HARVEY 206 PA your best bet for operation with constant frequency oscillators, measurement equipment, pulse generators, amplifiers and other equipment requiring regulated D.C. voltage. *For details get in touch with HARVEY of CAMBRIDGE.*



## **HARVEY RADIO LABORATORIES, INC.**

439 CONCORD AVENUE • CAMBRIDGE 38, MASSACHUSETTS

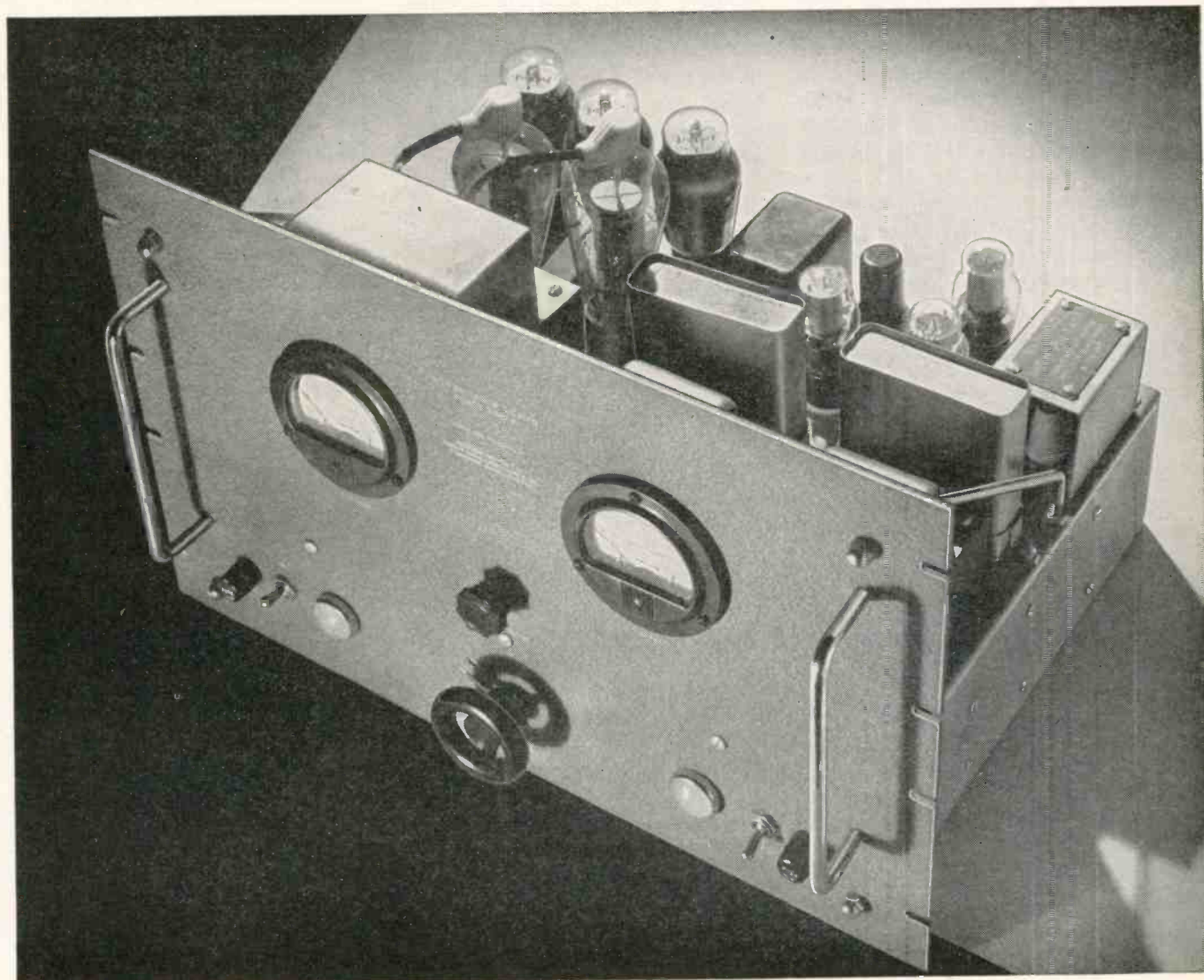

# INDUSTRIAL CONTROL

Phototubes for Railroad Operations.....	152
More Accurate Liquid Level Indicator for Aircraft Industry...	152
Elongation Recorder for Materials Testing.....	154
Pipe Gaskets Tested for Pressure.....	158
Simplified Training for Assembly-Line Workers.....	168
Electronic Equipment for Commercial Aircraft.....	184
Filters for Electronic Equipment.....	200

## Phototubes for Railroad Operations

AT THE NEW DIESEL locomotive maintenance shop of the Erie Railroad, phototubes are used for two purposes—to open electrically operated overhead doors and for drying and elevating sand into overhead storage tanks.

The door control is actuated by the beam from the headlight of the approaching locomotive while it is still some distance away. This allows plenty of time for the ponderous doors to open and permit the locomotive to enter the shop without a preliminary stop.

A sun visor is provided over each phototube to prevent the sun from activating it. Pushbuttons inside the building operate the door-closing mechanism after the locomotive has entered.

The sand for the sand boxes of the 5400-hp four-unit diesel freight locomotives is dried by steam coils over a drum, into which the sand

flows by gravity as it dries. Into the side of this drum is welded a pipe, so shaped that it permits sand to spill over when the drum becomes full. About half-way down the interior of this pipe is welded a box containing a glass window on each side. Through these windows a beam of light is passed to a phototube.

When the drum becomes full of sand, the surplus flows over into the pipe and interrupts the beam of light. Compressed air is immediately turned on, closing the inlet to the drum and applying pressure to the top of the sand. The sand is blown into elevated bins, where it is ready for use in servicing the locomotives.

When the drum has been emptied, the windows of the box inside the pipe are again cleared and the lightbeam passes through them to reach the phototube. This turns off

the compressed air, re-opens the inlet to the drum, and allows it to fill again—ready for the next operation. This mechanism has proven much more dependable than any previous combination of springs, switches, or other mechanical action.

## More Accurate Liquid Level Indicator for Aircraft Industry

THE PRINCIPLE of operation of an electronic gas gage for bombing planes, recently announced by Minneapolis-Honeywell, can well be applied to a large number of manufacturing operations, in refineries, large storage vats, and even as a means of measuring the moisture content of wheat and other materials.

The illustration shows the installation of the gas gage units in a typical four-engined airplane. In the gas tanks are mounted capacitance units which connect to an electronic amplifier and meter mounted in the fuselage. Each capacitance unit consists of a piece of tubing which contains two smaller pipes inside to form the elements of an electrical capacitor. Gasoline can flow inside the tubing and between the two inside pipes. The minute current flow from one pipe through the gasoline to the other pipe shows the electrical capacitance of the gasoline. This changes with the height of the liquid within the tank unit and is measured electronically by the amplifier. Actuated by the amplifier, an indicating dial on the plane's instrument panel shows the contents of the tank in gallons.

### Unusual Conditions

The problem of determining fuel supplies is not an easy one for plane crews. Gasoline actually shrinks in volume with a drop in temperature and, from ground level to 25,000 feet, this shrinkage frequently reaches 10 percent. In addition, the level of gasoline constantly changes with the roll (or tipping) axis of the plane, giving false readings on conventional gages of as much as 20 percent error. This degree of error, when coupled with shrinkage and other



When diesel locomotives approach this Erie maintenance shop, the headlamp shines into a phototube which actuates a door opener and eliminates a preliminary stop while trainmen open the door

## .. This is Cardioid

"Cardioid" means heart-shaped. It describes the pickup pattern of a microphone as illustrated in this diagram. Unwanted sounds approaching from the rear are cancelled out and the pickup of random noise energy is reduced by 66%. The actual front to back ratio of reproduction of random sound energy is 7 to 1.

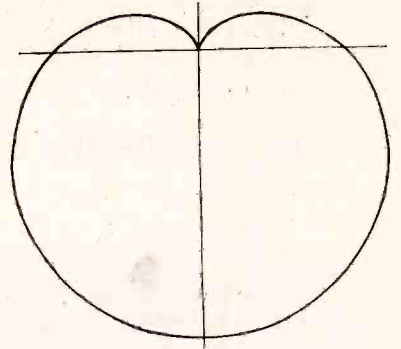

## .. This is Super-Cardioid

"Super-Cardioid" also describes a pickup pattern and is a further improvement in directional microphones. The Super-Cardioid has a wide front-side pickup angle with greater exclusion of sounds arriving from the sides and the rear. The front to back random sound ratio is 14 to 1 which makes it twice as unidirectional as the "Cardioid." A 73% decrease in the pickup of random noise energy is accomplished.

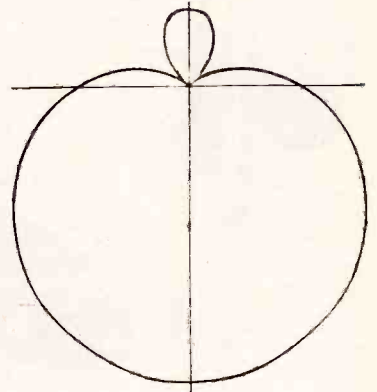

## .. This is Uniphase

"Uniphase" describes the principle by which directional pickup is accomplished in a single Microphone unit. This is a patented Shure development and makes possible a single unit "Super-Cardioid" Directional Microphone eliminating the necessity of employing two microphone units in one case—it gives greater uniformity in production, greater ruggedness, lower cost for comparable quality and more uniform vertical pickup pattern.

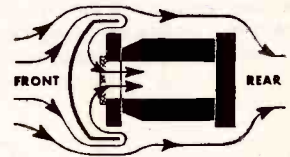

Sounds entering from front.

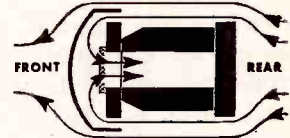

Sounds entering from rear.

## .. This is the result

### The SHURE Super-Cardioid

A decrease in the pickup of random sound energy by 73%—reduction of feedback and background noise—simplification of sound pickup are among the many advantages offered by the Shure "Super-Cardioid" Dynamic. These, plus faithful reproduction, are the reasons why Shure "Super-Cardioid" Microphones are used by more than 750 Broadcast Stations in the United States alone, by our Armed Forces throughout the world, and on thousands of Public Address Systems everywhere.

## SHURE BROTHERS

Designers and Manufacturers of Microphones and Acoustic Devices  
225 West Huron Street Chicago 10, Illinois



factors, can lead a pilot to believe that he has hundreds of gallons more (or less) available than are actually in the tank.

The needles of float-type fuel

gages fluctuate constantly. This is sometimes further amplified because at the low pressures encountered at high altitudes, the fuel boils, causing a foam to form—sim-

ilar to a bubble bath—on the surface of the gasoline and the float rides on top of the bubbles, thus indicating a still greater supply.

Developed at the request of the Air Technical Service Command, Wright Field, Dayton, Ohio, the new device is accurate within five percent under extreme conditions of temperature, altitude and plane attitude. This compares with at least a 15 percent error in the best of all existing means of aircraft fuel measurement. With no moving parts, bellows, gears, cams or levers to get out of calibration, the liquid level indicator weighs about 16 pounds, slightly more than present fuel measuring systems.

The unit now being manufactured is actually the second of two designs developed by Minneapolis-Honeywell. Both of these developed from a basic electronic circuit used by the company in an ice indicator which measures ice forming on wing and plane surfaces and turns on the deicer pumps before weight and bulk of the ice become dangerous.

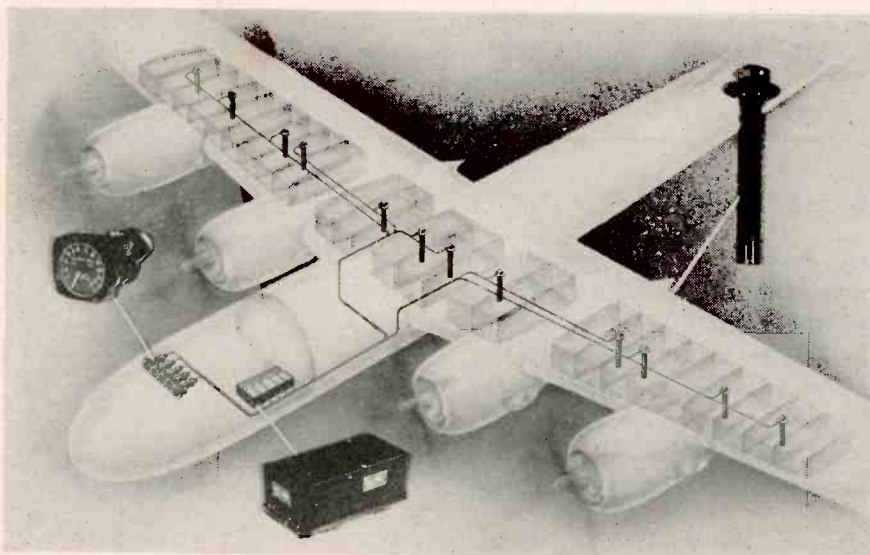

Gas-gage installations in a typical four-engine plane. The liquid level unit, shown at upper right, makes use of electrical capacitance and may find extensive use in industrial applications. Accuracy is within five percent as against fifteen percent for other devices used in fuel measurement

## Elongation Recorder for Materials Testing

**MILITARY NEEDS**—in aviation, ordnance, marine equipment, and industrial mechanisms—have forced greater tensile strengths, higher working limits and lower safety factors for many classes of materials.

In testing most materials, the stress-strain diagram is recognized as the fundamental characteristic and helps to find modulus of elasticity, hysteresis, elastic deformation, proportional limit, yield strength, and proof stress. Essentially the Olsen high magnification recording unit is a specially designed extensometer which transmits the characteristics of the material under test by electronic means to a letter-size chart applied to the recorder drum.

### Degree of Strain

The strain of most rigid materials in the elastic straight-line region is very little. In a piece of plain carbon, cold C. R. steel it may be 0.001-0.002 in./per inch length of material, corresponding to a load at 30,000-60,000 lb/per

By JENS SIVERTSEN  
Electrical Engineer  
Tinius Olsen Testing Machine Co.  
Philadelphia, Pa.

square inch; for cast iron it may be as little as 0.00025-0.0005 in., and for high grade heat-treated

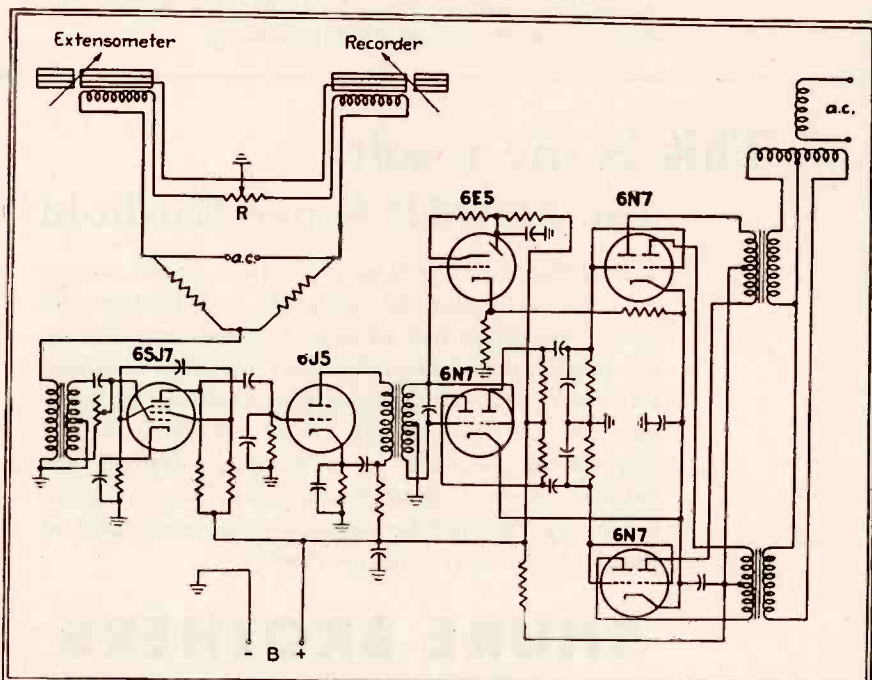
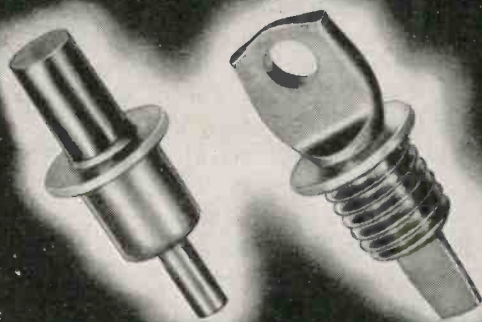
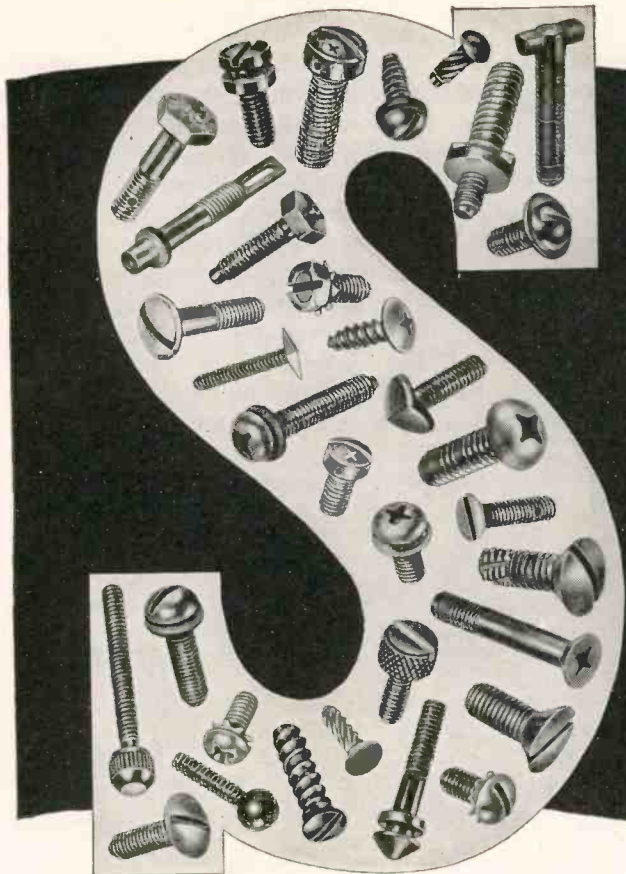

Fig. 1—Electronic amplifier and Wheatstone bridge arrangement used in the materials tester. The motor speed is variable and reversible depending on the signal from the bridge circuit

# Choose the Right Fastenings— PLAN THEM EARLY In the Product Design Stage



## 3 Standard Fastenings for Production Efficiency



**1 Phillips Recessed Head Screws**—The modern, effective, time-saving fastening device proven in tens of thousands of assembly lines. Other standard head styles are also available.



**2 Self-Tapping Machine Screws**—Eliminate separate tapping operations for fastenings to castings, heavy gauge sheet metal, and plastics. Also available with Phillips Recessed Head.



**3 Washer-Screw Assemblies**—When use of lock washers is indicated, the time-saving of pre-assemblies is obvious. Also available in standard slotted head styles.

*"Cold-forging" —proof #33  
... more each month*

The degree of perfection you will obtain on that vital fast assembly job may very well depend on the fastenings chosen for your product. That's why it is important to play safe by making your precise choice early in the design stage. Remember—no assembled product can be better than its fastenings.

Whether your need be a featured standard fastening or a part especially designed to meet your specific requirements—Scovill can help you. Our broad experience in fastenings and our demonstrated ability in special design make Scovill your logical choice.

The special purpose item featured above (in intermediate and finished stages) is one of many examples of our ingenuity in special design and cold-forging. Our special processing of this part, too, meant substantial savings in money—materials—motions.

Call our Fastenings Expert to help you choose—profit by Scovill skill in design and cold-forging. Call today.

# SCOVILL MANUFACTURING COMPANY

## WATERVILLE SCREW PRODUCTS DIVISION

WATERVILLE 48, CONN.



TEL. WATERBURY 3-3151

NEW YORK, Chrysler Building • DETROIT, 714 Fisher Building • CHICAGO, 135 South LaSalle Street • PHILADELPHIA, 18 W. Chelton Avenue Building  
PITTSBURGH, 288 2 W. Liberty Ave. • SYRACUSE, Syracuse - Kemper Insurance Bldg. • LOS ANGELES, 2627 S. Soto St. • SAN FRANCISCO, 434 Brannan St.

tool steel, it may be as much as .005 in.

Instruments to measure and record these small dimensional changes were made 50 years ago. They used long specimens which were cumbersome to use and the operator had to be an expert. However, it is remarkable how good the results were with such equipment.

The recorder was ready and a few were in use before the war, by people who were not afraid of the radio tube in industry. Some organizations like Chrysler, Ford and the U.S.S.R. had quite a few of them. When the war came, the requirement for accuracy and volume of testing increased rapidly, and the work had to be done by operators with no previous training in this field. Since the recorder was simple to operate, anybody with normal intelligence could learn its use in a few hours.

#### Modern Design

The complete instrument comprises three units: the extensometer which is attached to the specimen, the electronic amplifier, and the recorder unit. In the extensometer is a magnet coil with an air gap between two iron cores. In the recorder unit is a similar coil and air gap. These two coils and their air gaps form an automatically balanced electrical circuit. The air gap in the extensometer is actuated by the elongation of the specimen. The air gap in the recording instrument is actuated by a micrometer screw which is rotated by the same motor which drives the recorder drum.

The electronic circuit is shown in Fig. 1. It consists of an a-c Wheatstone bridge, having a permanent base of two closely matched resistors. The other arms consist of one induction coil with a magnetic core and an air gap actuated by the strain in the test piece, and one identical inductor arranged in the recorder box actuated by a micrometer screw. The screw is synchronized by gears with the recording drum. The reversible motor drives the arrangement as a self-balancing assembly.

The output from the bridge energizes the primary of an input transformer. The secondary feeds

the grid of a 6SJ7 pentode and the rest is a straightforward amplifier up to the two 6N7 output tubes. The plates of these tubes act in respect to the shading coils of the motors as variable impedances which for large signals may become negative. In this way, the motor becomes automatically reversible with change in phase of the incoming signal. The motor speed becomes variable over a large range and causes the recording drum to

pair the sensitivity of the recorder. For this reason, the resistance balance can be adjusted by the small potentiometer *R*, shown on top in the bridge circuit, while observing the 6E5 balance indicator.

The 6E5 tube will also indicate whether the motor keeps the bridge circuit balanced at all times, which means that the recorder follows the elongation of the specimen minutely. Some small change in resistance may take place during

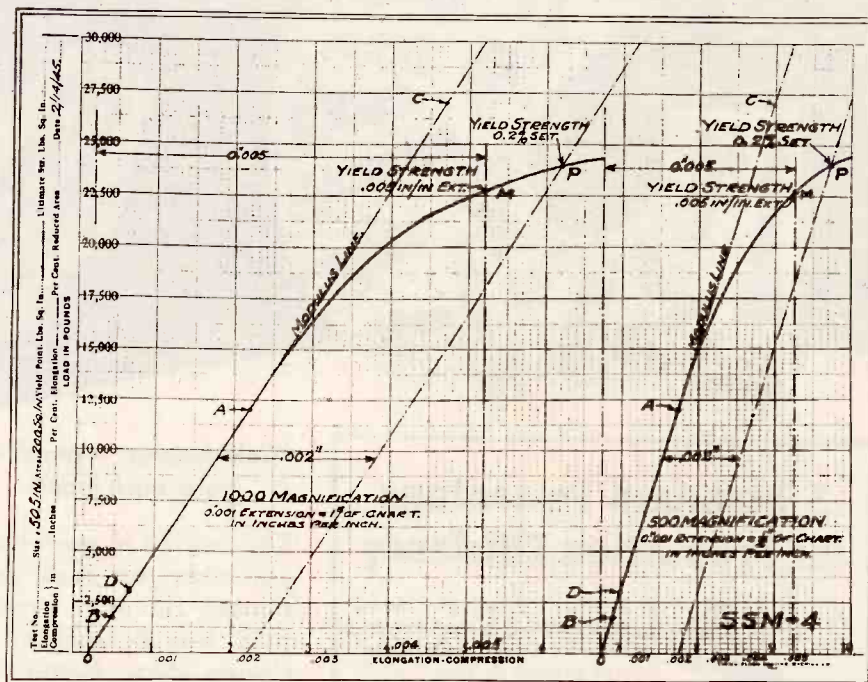

Typical stress-strain diagram (not retouched) made with a 30,000-lb. Olsen testing machine. Such recordings can be used to follow a material during cold working, heat treatment, and other operations, to provide a product with greater uniformity in shape, size and dimensions in service

follow smoothly any strain of the specimen.

In spite of the very high sensitivity obtained, 0.000001 to 0.000005 in. elongation of the specimen, the amount of hunting is negligible. Some of the models are supplied with dynamic brake (aluminum disk in a magnetic field) while many are without this brake.

#### Balance

In view of the high sensitivity and the low signal, a 6E5 tube is used for balance adjustment. The arrangement is such that only inductance unbalance can affect the motor, as voltage caused by resistance unbalance is 90 deg. out of phase. A large resistance unbalance will, however, im-

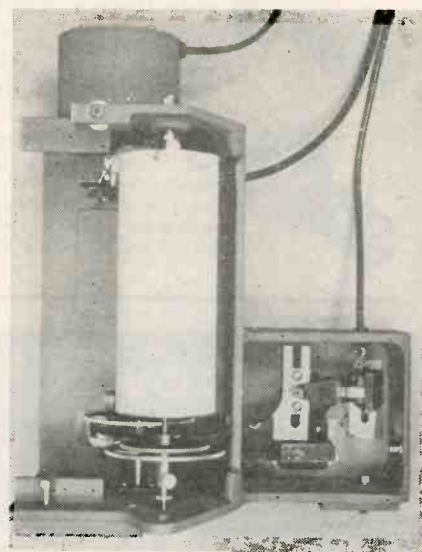
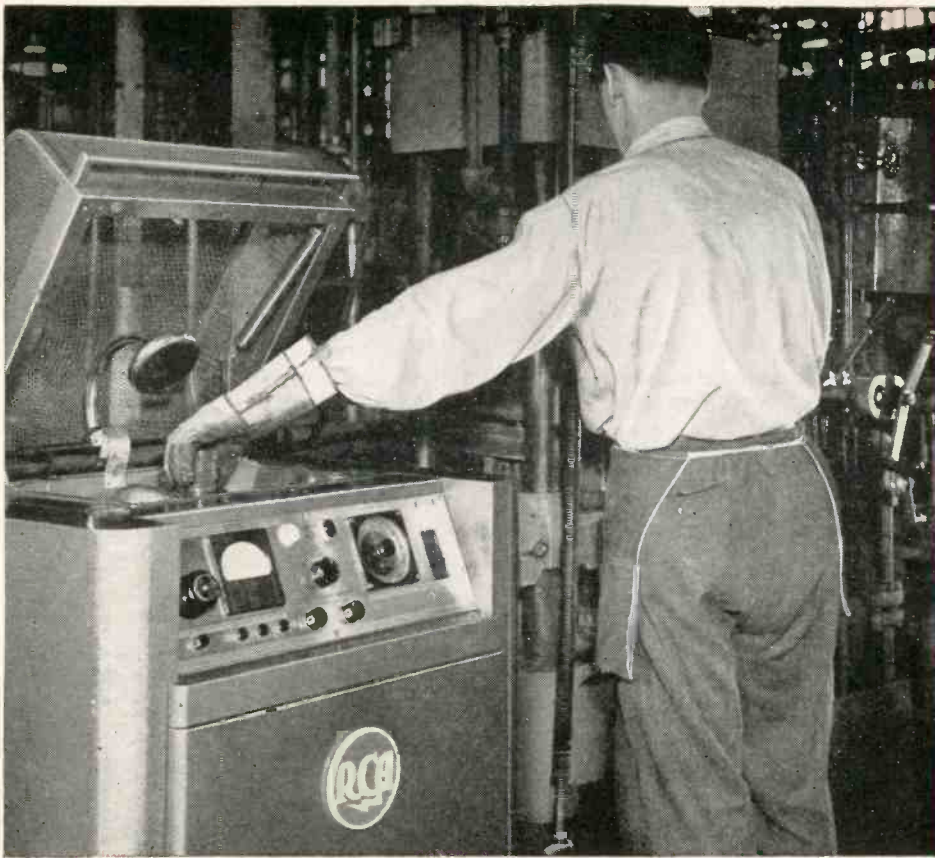

Fig. 2—Mechanical features of the recording unit



← Cost of finished pieces was reduced 40% by this RCA preheating unit at Kellogg Switchboard and Supply Company.

Telephone "cradle" molded by Kellogg; with cold molding, 4 press cycles per hour—with electronic preheating, 6¼ cycles. ↓



## Kellogg Switchboard Reduces Cost 40% with Electronic Heat

**Press Output Increased 56%; Molding Pressure Lowered; Warpage and Blistering Reduced with New RCA Automatic Plastics Preheater**

**Application:** Kellogg Switchboard and Supply Company, Chicago, compression-molds a large quantity of telephone parts, including the "cradle" shown above. A four-cavity mold is used; each cavity takes 2 preforms weighing 1.75 ounces each. Material: Bakelite BM 2498. Molding Temperature, 320°F.

To step up production on this part, the Kellogg Switchboard and Supply Company

installed RCA electronic preheating equipment. The complete charge of 8 preforms per mold is now preheated for 35 seconds to a uniform temperature of 220°F.

According to Mr. W. G. Cregeen, Assistant Shop Superintendent of the Kellogg Plant, electronic heating reduced the cost of finished pieces by 40%, and warpage and blistering, which were previously problems, are no longer troublesome.

Press Closing Time  
Curing Time in Mold  
Press Cycles per Hour  
Molding Pressure  
Mold Damage  
Mold Life  
Dimensional Tolerances and Stability

Cold Molding	Electronic Molding
1 min.	1 min.
5 min.	2½ min.
4	6¼
125 psi	75 psi
	Less
	Increased
	Better

**RCA Equipment is Available!** RCA's new compact 2000-watt electronic preheating unit for the plastics industry is available for quick delivery. Easy to install, completely automatic, it will heat a pound of average molding material to 275°F in 40 seconds, providing uniform plasticity throughout. The coupon below, or a letter, will bring you complete details. RCA application engineers are at your service. Address: *Radio Corporation of America, Electronic Apparatus Section, Box 70-195H, Camden, N. J.*

**RCA  
ELECTRONIC  
HEAT**



**BUY  
WAR  
BONDS**

**RADIO CORPORATION  
OF AMERICA**

**RCA VICTOR DIVISION, CAMDEN, N. J.**

**SEND THIS TODAY FOR QUICK REPLY**

RCA, Electronic Apparatus Section, Box 70-195H, Camden, N. J.

Please rush me free data on the completely automatic RCA electronic preheater, Model 2B, which is available for quick delivery. Also send "Data Form P."

Name.....

Company.....

Position.....

Address.....

City..... Zone..... State.....

70-6236-193

the first hour of a day's work, as the coils do not heat completely uniformly.

Figure 2 shows the mechanical parts of the recorder. The rack carrying the pen parallel to the axis of the recording drum has been removed. This pen provides the load ordinate for the chart and many types of testing machines give this automatically as an integral part of the weighing system of the machine.

A typical recording made with a 30,000-lb testing machine is shown. The specimen is a round steel bar 0.505 in. in diameter, which has a cross-section of 1/5 square inch. The testing machine gives load values in pounds; material constants are generally given in pounds per square inch. To get

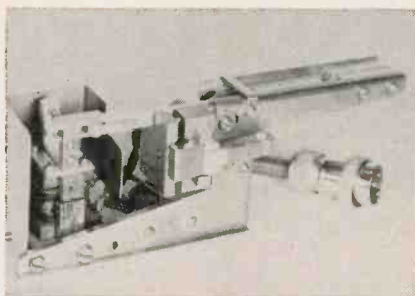

Fig. 3—One type of extensometer for the elongation tester

these, we divide by 1/5 or multiply by 5. For example, the proportional limit is at point A on the curve. The corresponding load reading from the chart is 12,000 lb. The proportional limit is, therefore,  $12,000 \times 5 = 60,000$  lb per square inch.

If we measure along the elongation axis on the original graph,

we find the extension between origin and A equal to 2 in. Since the magnification is 1000 this represents 0.002 in. strain.

The modulus of elasticity is therefore:

$$E = \frac{60,000 \text{ lb per sq. in.}}{0.002 \text{ in. per inch}} = 30 \times 10^6 \text{ lb per sq. in.}$$

The right side of the chart shows the same curve with magnification of 500, which is used extensively in routine production testing, allowing a number of curves on the same chart. In view of the ease whereby the curve is obtained, the time may not be far off that all quality materials will be bought on the basis of a curve. Thus, a structural designer may now be able to use a safety factor of 10, 20, or 30 percent instead of 500 percent.

## Pipe Gaskets Tested for Pressure

ELECTRONICS has come to the aid of engineers coping with one of the problems of pipeline equipment design—the uneven distribution of gasket pressure. Such a condition often leads to costly leaks. A new tester utilizes an audio howl as an aid to measuring pressures exerted by rubber gaskets in pipe couplings, clamps and repair sleeves. Called a Sealometer, it was developed by engineers of the Dresser Manufacturing Division of Dresser Industries, Inc.

In many types of pipe, a thick rubber gasket, compressed by bolting down iron clamps, is used to

make a seal around the pipe. The unit pressure of this rubber gasket must exceed the pressure of the gas or liquid inside the line in order to prevent leakage. If there is

any variation of the gasket pressure, the minimum pressure is the one which determines the safeness of the joint. It is very important to determine accurately the distribu-

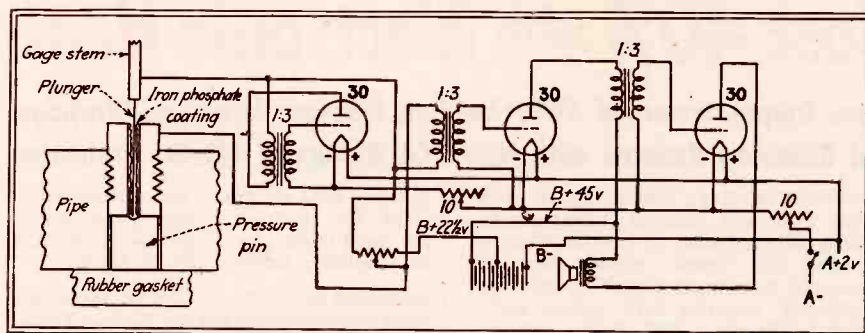
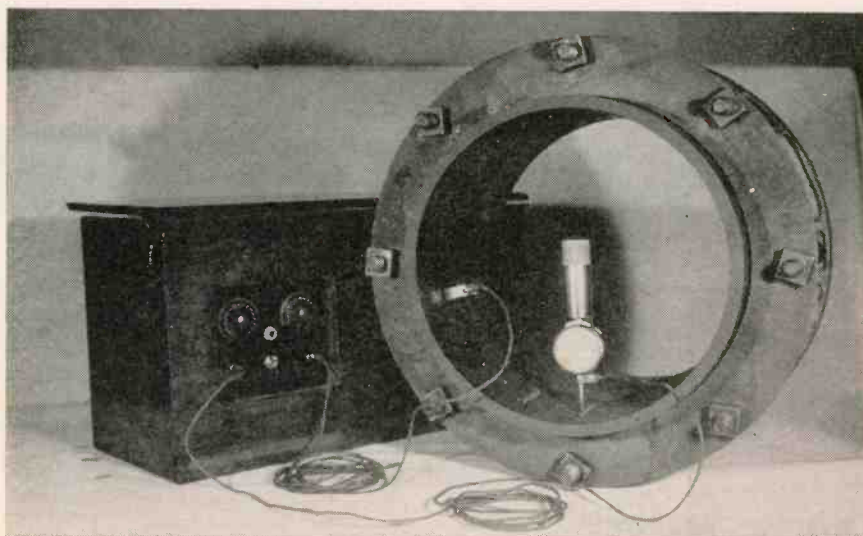

Fig. 1—Assembly details of the gage applied to a pipe gasket and the electronic circuit of the instrument for measuring gasket pressure in pipelines. When pressure is applied manually to the gage head, the plunger moves the pin away from contact with the shoulder of the threaded bushing



Complete setup of gage and audio oscillator-amplifier arranged to determine the variation of gasket pressure that occurs at different points of a pipeline joint

tion of the pressure which the gaskets exert in order to properly design a successful joint.

Most gasket tests have been based on the assumption that the pressure was uniformly distributed and that the unit pressure was equal to the total load divided by the area of the gasket. The problem of measuring the pressure which is exerted by an elastic solid such as rubber is much more com-





# VIBRASHOCK

PROTECTS NAVY'S *NEWEST* TRANSMITTER

The Collins Autotune Transmitter — one of the newest and most versatile units of Naval radio equipment — is installed on most two-place and larger types of Naval aircraft.

The Robinson Vibrashock suspension is specified and installed to carry this transmitter and to protect it against the rugged conditions of combat and aircraft carrier service.

Robinson engineers build the only complete fully engineered suspension guaranteed to absorb over 90% of multi-directional vibration throughout the entire aircraft operating range. This is an efficiency rating far beyond accepted shock mount standards, and makes possible performance and reliability previously unobtainable for radio and electronic equipment.

Our services are available to aircraft, radio and electronic manufacturers and users in connection with any mechanical or electronic unit requiring protection against vibration and shock. ROBINSON AVIATION, INC., 730 Fifth Avenue, New York 19, N. Y., 3757 Wilshire Blvd., Los Angeles 3, Calif.

\*Trade Mark

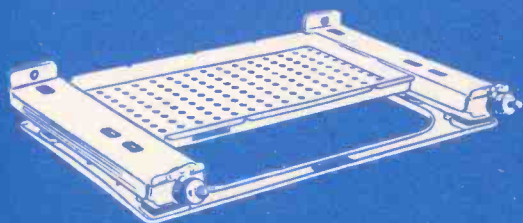

# Inside Facts ON PEERLESS HERMETICALLY SEALED TRANSFORMERS

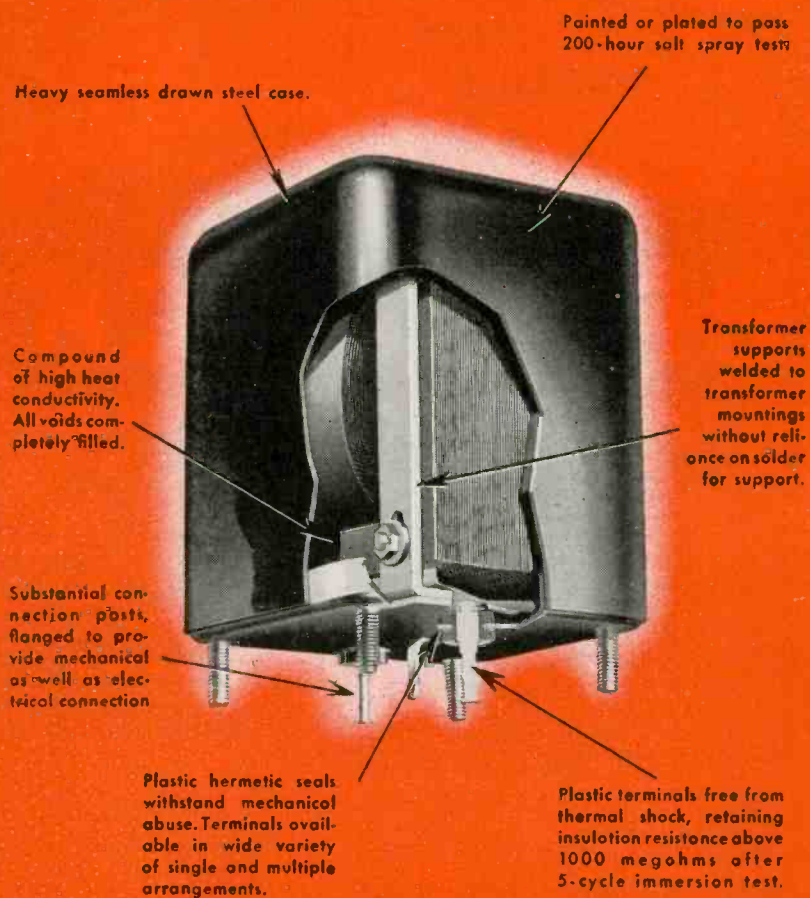

Pearless Hermetically Sealed transformers can be tropicalized to desired specifications and are available in large production quantities. Complete testing facilities for Navy, Signal Corps and Air Corps specifications.



Catalog available to  
Industry Personnel



# PEERLESS

ELECTRICAL PRODUCTS CO.

6920 MCKINLEY AVENUE • LOS ANGELES 1, CALIFORNIA

plex than the measurement of fluid pressure. In the latter, the displacement of fluid necessary to actuate a gage does not usually affect the applied pressure. In measuring rubber pressure, any appreciable displacement of the rubber will cause a considerable change in the pressure being measured. This introduces an error of unknown proportions.

Two methods existed for determining force or pressure with very minute displacement. One used a quartz crystal and the other used a sensitive carbon pile. Both employ large instruments and readings could not be taken close enough together to plot satisfactory pressure distribution curves for the gasket. Also, frequent calibration is necessary.

The principle of operation of the Sealometer involves measuring the force exerted by the gasket upon the end of a "pressure pin" having an area of exactly 1/100 of an inch. Movement of the pin is limited to a few millionths of an inch—thus reducing the displacement error to a negligible value.

### Test Procedure

For testing, each pressure pin is accurately fitted in carefully reamed holes at desired points in the test specimen and adjusted by means of a special screw so that one end is flush with the surface contacting the gasket. A specimen thus prepared has packing surfaces substantially the same as those in a joint in actual use, and the behavior of the gasket is not altered in any way. After the rubber ring in the test specimen is compressed, the pressure acting upon each pin is measured by applying an opposing force until a balance is obtained and the few millionths of an inch displacement of the pin occurs. This breaks the electronic circuit, setting up an audio howl. Figure 1 shows the wiring circuit.

Three important factors influenced the design of the wiring circuit for the Sealometer. Frequent opening and closing of the circuit in measuring the pressures would foul the contacts unless a very small current were used. Also, the limitation of movement on the pressure



## Optics speed the development of television

One of the important steps toward better reception in television is a cathode ray tube face plate which is ground and polished to precision specifications. It is an essential element in the improved optical systems that result in larger, sharper images.

The new science of electron-optics is already an old story in our plant. For one of our most important assignments is the volume production of the face plates, mirrors and other optical components so necessary to the electronics of modern war. Work of this nature is helping our compact group of optical technicians to perfect the very skills that television manufacturers need.

We have developed new machine techniques with which we can hold the closest tolerances when necessary. This assures mass production and economy without loss of quality. These advantages will be particularly interesting to manufacturers who face speedy reconversion in a competitive market.

Our specialty is "custom-built" optics. We make no complete products of our own but work exclusively for other manufacturers. Our optical technicians will be glad to help you toward reconversion. Possibly you have a problem for which we already have a solution.

for precision OPTICS come to

**AMERICAN LENS COMPANY, INC.**

45 Lispenard Street, New York 13, N. Y.



LENSES . . . PRISMS . . . FLATS . . . REFLECTORS

# How Fedelco-Sealing Protects

## this Automatic Electric Co. Relay Against Environment

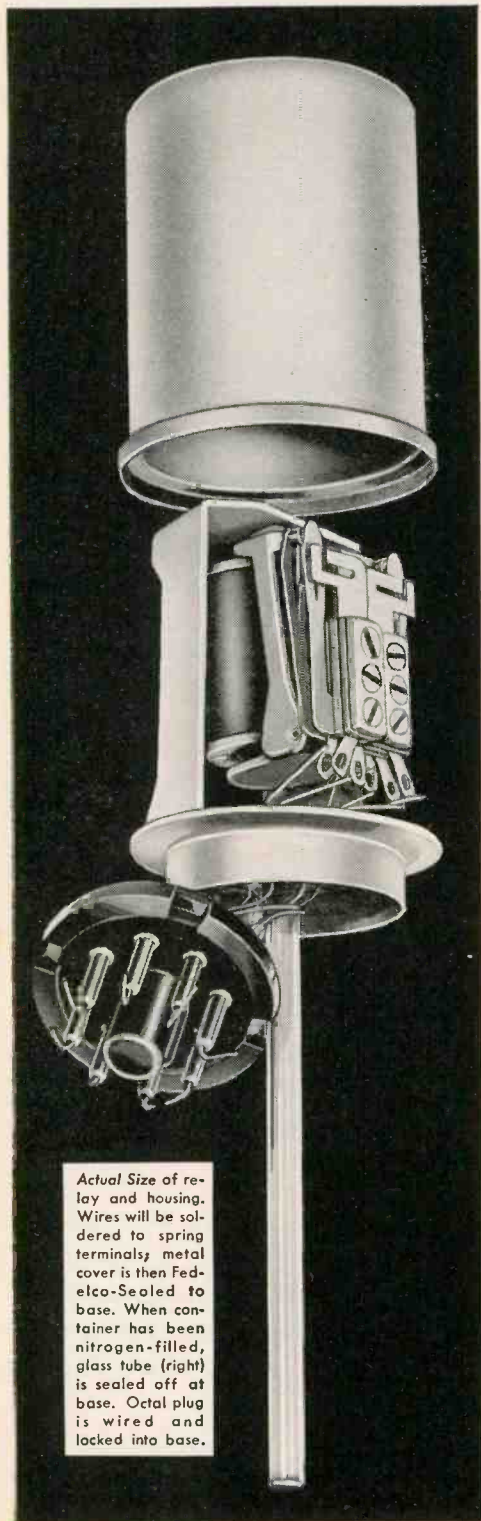

Actual Size of relay and housing. Wires will be soldered to spring terminals; metal cover is then Fedelco-Sealed to base. When container has been nitrogen-filled, glass tube (right) is sealed off at base. Octal plug is wired and locked into base.

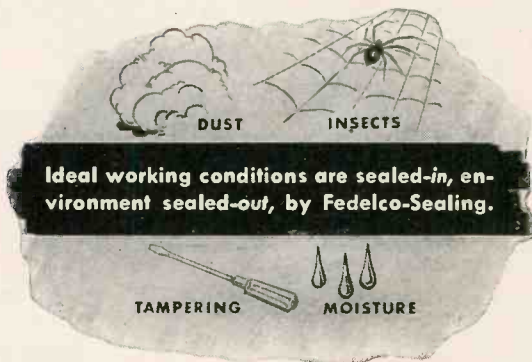

To prevent tampering with electrical and mechanical devices, and to keep out bugs, dust and moisture, the Fedelco-Sealing process encloses these devices in a hermetically sealed metal housing, which can be exhausted and filled with dry air, or other gas, at atmospheric pressure. The enclosure is designed to withstand vibration and shock of any kind specified. The Fedelco-Sealing process assures the long life and unflinching performance built into your product, by eliminating the effects of environment.

Ship your product to us, and we will Fedelco-Seal it for you; or, when you require quantities large enough to do your own Fedelco-Sealing, we will design for you complete methods and equipment as used in the Federal Electric Plant. Get the details of this new protection now—from any of the offices listed below.

### How Fedelco-Sealing protects this Aviation Type S Automatic Electric Relay

An 8-point multiple header is sealed into the round metal base. The relay is fastened to the U-shaped bracket. Wires are soldered to spring terminals and carefully cleaned to eliminate all traces of flux or other foreign matter. The relay is carefully checked for all operating characteristics. The metal cover is then Fedelco-Sealed onto the base.

Air is exhausted, and the container flushed with nitrogen for complete removal of oxygen. Finally, the case is filled with dry nitrogen and the tube sealed off, close to the base. Terminals are then wired to the octal plug, which is locked into position, completing the assembly. Thus protected from dust, moisture, and fungus, the relay provides longer life, and decreased maintenance.

### Get the details on Fedelco-Sealing — NOW

The use of Fedelco-Sealing is increasing rapidly. You will want to know about this method. Send us samples of your product to be sealed, or describe your product and your problem. Write or call any of the offices listed below.



**FEDERAL ELECTRIC COMPANY, INC.**

8700 South State Street, Chicago 19, Illinois • Phone VINcennes 5300

E. B. Mathewson Company, sales agents • 612 North Michigan Avenue, Chicago 11, Illinois • Phone WHIttehall 4822

Sales offices: New York 17, N. Y.—Graybar Bldg. • Chicago 11, Ill.—612 N. Michigan Ave. • Philadelphia 7, Pa.—Real Estate Trust Bldg.  
Kansas City 8, Mo.—2017 Grand Ave. • Atlanta, Ga. • Troy, N. Y.—17 Bank Street

**FOR ALL ELECTRICAL APPLICATIONS --**

**BH EXTRA FLEXIBLE FIBERGLAS SLEEVING**

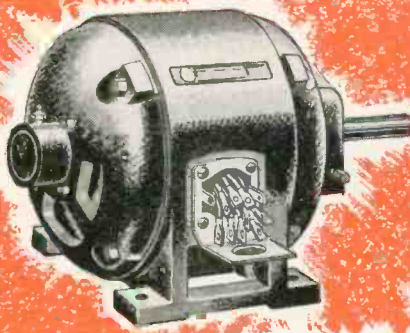
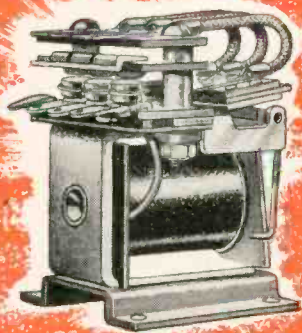

**WON'T HARDEN, CRACK OR ROT!**



**SNUB TEST**

Proves BH Non-Fray Feature

Make this test yourself. Tap a piece of ordinary saturated sleeving on your desk top and see how easily it frays. Then do the same with BH Extra Flexible Fiberglas Sleeving. It only fuzzes a little—doesn't break down—doesn't fray.

**THE RESULT**



◀ The BH Way



The Ordinary Way ▶

**BH EXTRA FLEXIBLE FIBERGLAS SLEEVING**

**2 WAYS BETTER**

**NON-FRAYING • NON-STIFFENING**

**WHY** give a few cents worth of electrical insulation a chance to be the weak link in your product? Use BH Extra Flexible Fiberglas Sleeving—the one insulation with all these advantages:

It is permanently non-fraying, non-stiffening and non-burning, by virtue of the exclusive BH process. It will not dry out, crack or rot, retaining its original unusual resistance to high and low temperatures, moisture, oil, grease and chemicals indefinitely.

If you want an all-purpose sleeving that simplifies assembly and maintenance and gives longer maximum protection, standardize on BH Extra Flexible Fiberglas Sleeving. Available in all standard colors and sizes from 1/8" to No. 20, inclusive. Write for free samples today and compare by actual test!

**HOW TO KEEP CUSTOMERS COOL AT 1200°F!**

Direct contact with heat up to 1200°F does not harm BH Special Treated Fiberglas Sleeving, the non-burning, unsaturated, flexible-as-string sleeving that stays supple and won't fray when cut. Made in natural color only—all standard sizes. Get this extra protection now and keep customers' temper cool, too!

ALL BH PRODUCTS AVAILABLE IN STANDARD 36" LENGTHS and 500-FT. COILS



ALSO SLOW-BURNING IMPREGNATED MAGNETO TUBING • SLOW-BURNING FLEXIBLE VARNISHED TUBING • SATURATED SLEEVING • A.S.T.M. SPECIFICATIONS

**BENTLEY, HARRIS MANUFACTURING CO.**

**Dept. E Conshohocken, Penna.**

WRITE FOR YOUR  
COPY TODAY!



**Akra-Ohm  
Resistors**  
Accurate Fixed  
Wire Wound  
Types

*This New Bulletin  
tells you what you  
want to know about*  
**ACCURATE FIXED  
WIRE WOUND  
RESISTORS**

DIMENSIONAL SPECIFICATIONS • MOUNT-  
ING AND TERMINAL DESIGNS • POWER  
DISSIPATION • TEMPERATURE COEFFI-  
CIENT OF RESISTANCE • MAXIMUM  
RESISTANCE CHARTS • RESISTANCE  
ALLOYS • MOISTURE AND FUNGUS  
PROOFING • HERMETIC SEALING

*Shallcross Types Designed to  
Meet JAN-R 93 Specifications*

**SHALLCROSS MFG. CO.**

DEPT. E - 75 COLLINGDALE, PA.

ENGINEERING • DESIGNING • MANUFACTURING

PIPE GASKETS

(continued)

pin in order to avoid errors from distortion of the rubber gasket made it necessary to have a current that could not jump a gap of a few millionths of an inch. The problem of insulating the pressure pin so the current would flow properly also was involved.

One test lead of the unit connects to the stem of the indicator gage. The other test lead is attached to the specimen being tested. Thus the current travels through the shoulder of the adjusting screw by way of the pressure pin to the plunger of the gage stem.

*Special Insulation*

The circuit is broken when pressure on the plunger moves the pin away from contact with the shoulder of the adjusting screw. Difficulty was had with insulation of the pin on all surfaces where it comes in contact with the reamed hole. A coating of iron phosphate finally was selected to be the insulating layer. While not a superior insulation, it is sufficient to interrupt the slight current of the circuit. This material overcame the tendency to cause the pin to stick that other types of insulation exhibited.

The opposing force applied on the pressure pins is exerted manually. The stem of a dial indicator gage is fitted with a special needle-like plunger which can be inserted through the hollow adjusting screw to engage the pin. Mounted over the stem is a handle housing an accurately calibrated engine indicator spring that requires one pound of pressure for each 0.01-inch deflection. Pressure on the handle is transmitted to the pin through the plunger, the pressure being measured by the spring and recorded on the dial indicator. The area of the pin is 0.01 inch and each pound of pressure applied manually represents 100 psi.

*Advantages*

Since the audio signal sounds when the balanced pressure condition is reached, the operator can take readings without lifting his eyes from the gage. This makes possible the reading and recording of pressures at the rate of about 150 per hour. Accuracy has been



**Coils by the thousands  
—engineered one by one**

REGARDLESS of the thousands of electrical coils Anaconda engineering has designed, still each one is strictly a custom-built job created to precisely meet a specific need.

Type, size, shape winding, insulation, treatment, cost—countless variables—are analyzed and specified to arrive at the proper coil for the intended use.

Anaconda magnet wire, another product of Anaconda engineering, is quality-controlled from copper mine to winding.

Think of that advantage—wire manufacture guided by long experience in making coils—coil production benefitting from the counsel of wire specialists.

Manufacturing facilities too are outstanding—modern, efficient plants and thoroughly skilled personnel.

For magnet wire and coils offering long, trouble-free service, contact our engineering service through any sales office.

42892



**ANACONDA WIRE & CABLE COMPANY**

*Subsidiary of Anaconda Copper Mining Company*

GENERAL OFFICES: 25 Broadway, New York City 4

CHICAGO OFFICE: 20 North Wacker Drive 6

Sales Offices in Principal Cities

*Magnet wire and coils*  
**ANACONDA WIRE & CABLE COMPANY**

# Advantage index—

**E-E**

## ...for improved tube-equipment operation

Evidenced in these four E-E electronic vacuum tubes, is advanced engineering and design. Each incorporates specific features which are in part responsible for its wide specification in critical applications. For example, EE-873 is a half-wave, grid control rectifier. Continuously variable output is possible, or on and off control. It is ideally suited to industrial use, electronic and communication control, induction

heating, keying transmitters, etc. Plate voltage rating is 10,000 max. peak plate current 5.0 amps. at condensed mercury temperature of 20°-50° C.

E-E Types 300, 200 and 100TH have specialized advantages also. Here again, each is extensively used for important requirements in various electronic fields.

The E-E Data Book, describing in detail each type, is available on request without obligation.

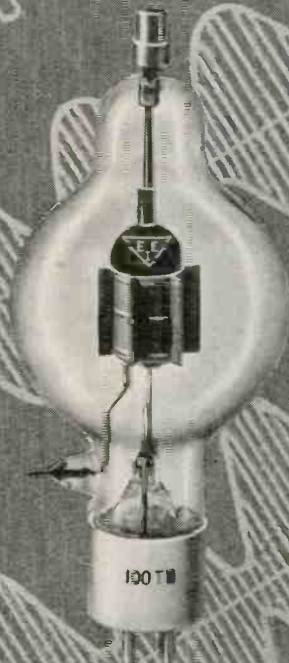
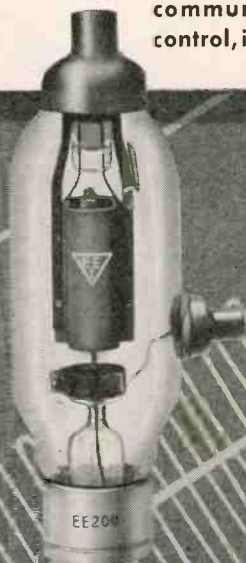

**ELECTRONIC  
ENTERPRISES · INC**



GENERAL OFFICES: 65-67 SEVENTH AVENUE, NEWARK 4, N. J.



# RADAR!

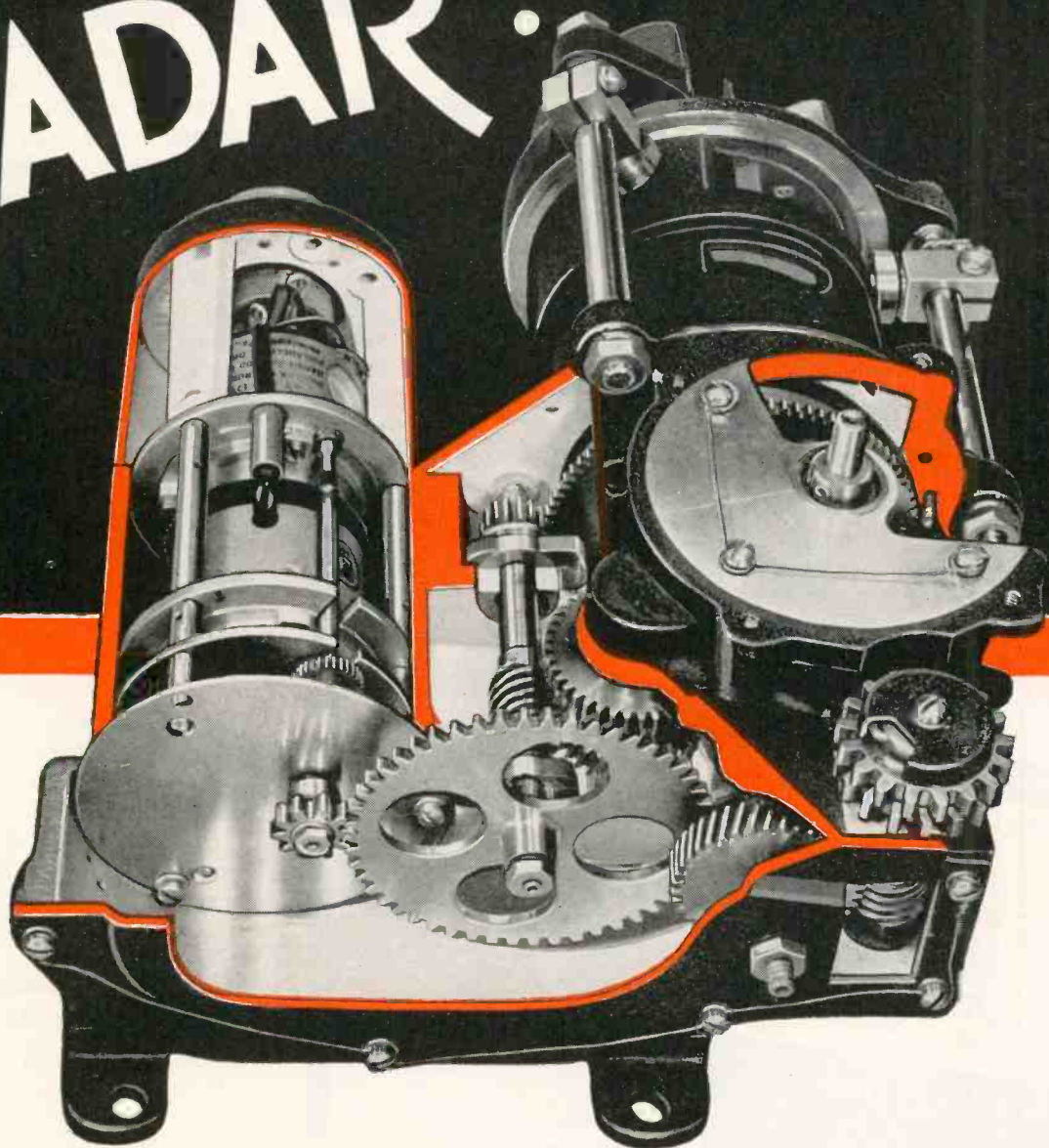

The Selsyn Torque Unit was one of the toughest jobs ever handed to a manufacturer. Frankly, we're proud of the way we tackled the exceedingly difficult production and inspection schedule for manufacturing these complete units in quantity for vital war needs. As will be seen from the cutaway view, the unit consists of 302 separate parts and is composed primarily of a complex gear train, including gears of many different types and sizes, some of which are fast moving, some slow, many of them subject to constant instant reversal as the controls shift position.

What the photograph can *not* show is that the entire unit must operate with NO BACKLASH WHATEVER. Only an engineer will realize what that meant in precision

production and assembly. Ordinarily obtainable "precision" gears were unsuitable. We had to set our own special standards, our own finishing and inspection methods. Aided by the precision production facilities already available in our shop, we were quickly and efficiently able to develop a production schedule that has never faltered on this vital war job. We suggest that a careful study of this and other outstanding Atlas accomplishments may well point the way to a solution of your own toughest problems in . . . PRODUCT DESIGN . . . PRODUCTION ENGINEERING . . . PRECISION MANUFACTURE.

ATLAS METAL STAMPING COMPANY  
ATLAS TOOL & DESIGNING COMPANY  
PHILADELPHIA 24, PENNSYLVANIA



*... a load off your shoulders*

*... onto ours*

ENGINEERS! DRAFTSMEN! ACCOUNTANTS! STUDENTS!

**ORDER TODAY!** Sensational **NEW**

# MULTI Slide Rule

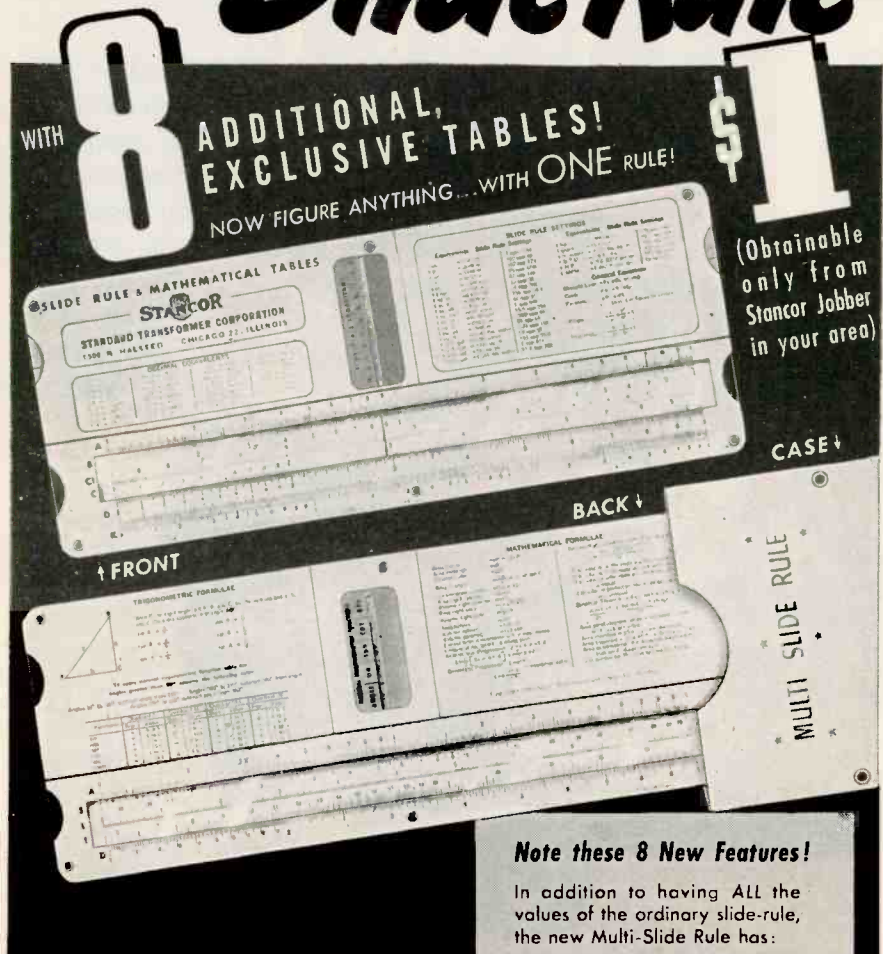

Clear, legible print . . . Tough, durable for long wear . . . Size 10" x 4" . . . Fits 3-ring binder . . . In case . . . Full instructions . . . **TRANSPARENT PLASTIC INDICATOR . . .**

STANCOR now offers the entire electronic industry the new Multi-Slide Rule. First developed for our own use, it is today made available to all . . . Greatly simplifies calculation of unlimited range of problems . . . A genuine professional rule—not a toy. This rule is obtainable **ONLY THROUGH STANCOR JOBBERS**. PLEASE DO NOT ORDER DIRECT. See your local directory for the name of the Stancor jobber in your city or, write for his name. Price of Stancor Multi-Slide Rule: One Dollar!—America's biggest slide-rule bargain—a service to the trade by Stancor.

STANDARD TRANSFORMER CORPORATION  
1500 N. HALSTED ST. CHICAGO 22, ILL.

### Note these 8 New Features!

In addition to having All the values of the ordinary slide-rule, the new Multi-Slide Rule has:

- 1 Four-place LOGARITHM TABLE
- 2 SIGNS and LIMITS of VALUE assumed by trigonometric functions
- 3 Table of NATURAL TRIGONOMETRIC FUNCTIONS
- 4 Table of TRIGONOMETRIC FORMULAE
- 5 Table of SLIDE-RULE SETTINGS
- 6 Table of GENERAL EQUATIONS
- 7 Long list of common MATHEMATICAL FORMULAE
- 8 DECIMAL equivalents of a fraction

OFFERED AS A SERVICE  
TO THE TRADE BY

# STANCOR

**ORDER FROM YOUR JOBBER**

checked at better than 98 percent correct by independent methods. Since the actual diameter of the pins is only 0.1128 inches, they can be spaced as closely as  $\frac{1}{8}$ -inch apart on the test specimen. Another advantage of the gage is that it permits pressure readings to be taken during assembly of a pipe joint as well as at any time thereafter. It is also possible to take readings while the joint is under line pressure. The gage is not affected by such factors as condition of the pipe or bloom on the gaskets, which seriously distort the results obtained by internal pressure tests.

In tests on one type of pipe joint, in spite of the fact that all bolts were tightened to exactly the same tension with a torque wrench, pressures ranging from 200 to 1000 pounds were recorded at various points around the gasket. On another, clamp pressures were found just above zero and dangerously close to the point at which leaks would occur. By using data compiled with the instrument, the pipe couplings were redesigned to equalize pressure throughout the gasket at a level well above minimum safety requirements.

### Simplified Training for Assembly-Line Workers

By S. FREDERICK AUERBACH  
*Engineer, Emerson Radio Television Corp.*

ISOMETRICS is the pictorial delineation of mechanical parts. More recently isometrics has been accepted and extensively used in the radio and aircraft industries for its clarity when used to show assembly of parts in exploded views.

During the war, many plants found that the personnel available for the assembly line was difficult and unsuited to train in blueprint reading. This condition necessitated an increased staff of key men and women to interpret and supervise the work. This type of assembly-line tutoring required many hours of training for supervisors and then, in turn, especially for workers who had to master the simple operations and commit them to memory. This was true even though the assemblies were broken down



# New **ELCO** A1-F RESISTOR 38,500 OHMS

its  
**FUNGUSIZED!**

Temperature coefficient is such that a minus 50° centigrade change in temperature from plus 22° centigrade will produce no greater than plus .01% change in resistance.

A1-F—15/32 long x 1/2" diameter. Mountable with 6-32 flat or filester screw No. 21 Tinned Copper wire leads. 1% standard accuracy. Non-inductive pie wound—1/2 watt, 200 D.C. maximum operating voltage. Fungusized varnish finish.

CAN ALSO BE MADE IN OTHER SIZES  
ACCORDING TO YOUR SPECIFICATIONS

**ALL ELCO RESISTORS ARE PRECISION WIRE-WOUND**

### SPECIFICATIONS:

"A-1"—15/32 long x 1/2" dia.—Mountable with 6-32 flat or filester screw. No. 21 tinned copper wire leads. 1 to 300,000 ohm value—1/2% standard accuracy—non inductive pie wound—1/2 watt, 30° C. temperature rise in free air—100° C. maximum operating temperature—200 D. C. maximum operating voltage. Baked varnish finish.

"A-R"—Same as A-1, with leads reversed.

"B-1"—15/16 long x 1/2" dia.—Mountable with 6-32 flat or filester screw. No. 21 tinned copper wire leads. 1 to 500,000 ohm value—1/2% standard accuracy—non inductive pie wound—1 watt, 30° C. temperature rise in free air—100° C. maximum operating temperature—300 D. C. maximum operating voltage. Baked varnish finish.

"M"—1-13/32 long x 3/4" dia.—Mountable with 6-32 screw—1/4 x .015 thick strap terminals—non inductive wound—1 meg ohm maximum resistance—600 volts maximum operating voltage—100° C. maximum operating temperature—1.5 watts—1% normal accuracy. Baked varnish finish.

"G"—15/32 long x 1/2" dia.—Mountable with 6-32 flat or filester head screw. No. 21 tinned copper wire leads. 1 to 500,000 ohm value. 1/2% standard accuracy—non inductive pie wound .8 watts, 30° temperature rise in free air. 100° C. maximum operating temperature. 200 D. C. maximum operating voltage. Baked varnish finish.

"B-R"—Same as B-1, with leads reversed.

**PROMPT  
DELIVERIES**  
on the New A1-F  
and others described  
and illustrated

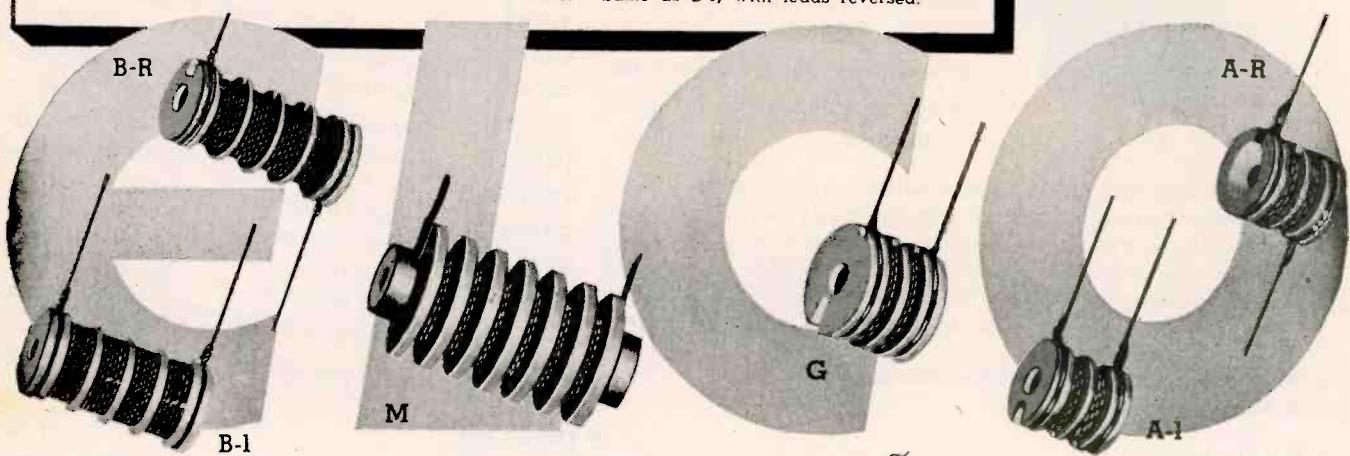

Get to know



**RESISTORS COMPANY**

114 West 18th Street, New York, N. Y.

Telephone - Watkins 9-4774-5

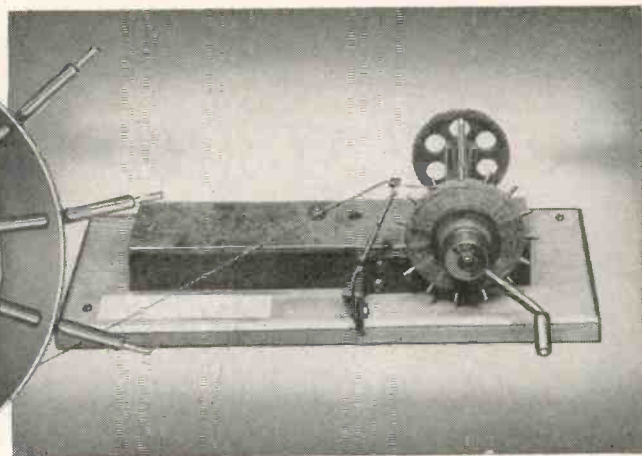
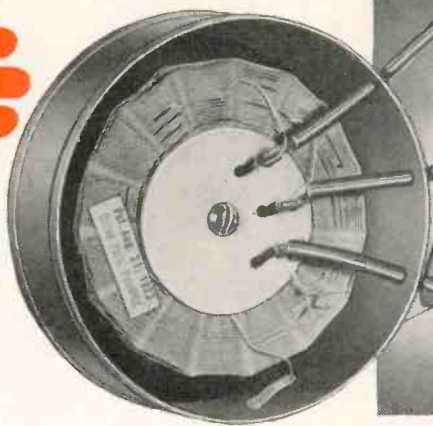

# *The Leader is Still the Leader*

The first radio coils were wound by hand . . . a laborious, time-consuming process. Then, in 1921, Sickles developed a manually cranked machine that did a much faster, *much better* winding job . . . slashing production time and costs and turning out the most efficient coil of its day.

Today, the Sickles R. F. Coil reflects twenty-four years of steady progress in electronics design and manufacture. Wound on a complex machine, the 1945 model is hermetically sealed against water, corrosive chemicals and gases — *permanently*. The deep-drawn zinc housing has wide-soldered joints and fused metal-to-glass bushings; all adjustments are enclosed and sealed with neoprene gaskets.

An enormous improvement over its ancestor of the early 20's, but still upholding the family tradition. . . . *Still the Leader!*

To Sickles' peacetime pioneering in the electronics field has been added a wealth of war-inspired advancement — new techniques that can benefit *your* production. May we tell you how? . . . Send us your requirements for prompt, helpful discussion.



THE F. W. SICKLES COMPANY  CHICOPEE, MASS.

# *SICKLES*

*Radio and Electronic Specialties for Today and Tomorrow*

YOUR SICKLES' REPRESENTATIVE

VERNON C. MacNABB  
P. O. Box 5904, Indianapolis 5, Ind.  
HARRY GERBER  
94 Portland St., Boston 14, Mass.

L. P. MACK  
1603 S. Michigan Ave., Chicago 16, Ill.  
GERALD B. MILLER  
8208 Santa Monica Blvd., Los Angeles, Cal.

NORMAN H. LAWTON  
1775 Broadway, New York 19, N. Y.  
AD. AURIEMA (Export)  
89 Broad Street, New York 4, N. Y., U. S. A.

**DEPENDABLE** performance and durability of a Test Instrument is assured by its design and sturdiness of construction. All B. R. C. instruments are ruggedly built to give exacting and precise direct reading measurements with simplicity of operation.

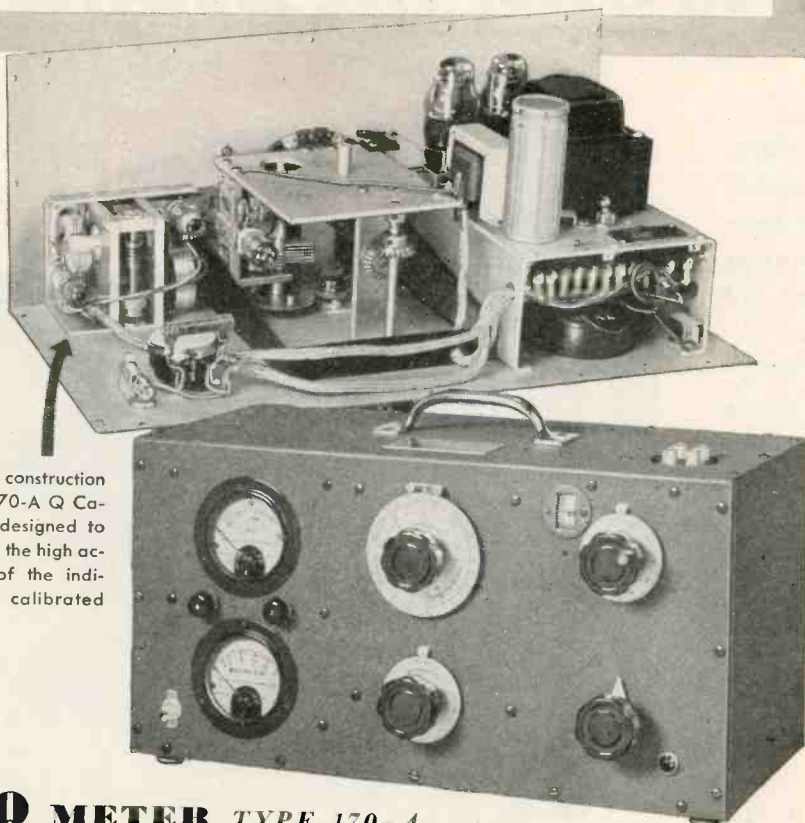

Rugged construction of the 170-A Q Capacitor designed to maintain the high accuracy of the individually calibrated dial.

### Q METER TYPE 170-A

This instrument embodies the general operating principles and characteristics of the 160-A Q-Meter but with such design and structural modifications as are required for accurate performance at higher frequencies. Has a frequency range of 30 mc to 200 mc.

**Q METER TYPE 160-A**—A standard for "Q" measurements with a reputation for accurate and dependable service. Has a frequency range of 50 kc to 75 mc which may be extended with external oscillator down to 1 kc.



DESIGNERS AND MANUFACTURERS OF THE "Q" METER, QX-CHECKER, FREQUENCY MODULATED SIGNAL GENERATOR, BEAT FREQUENCY GENERATOR, AND OTHER DIRECT READING TEST INSTRUMENTS

into many smaller components and cycles than the job ordinarily warranted. It also required many more checkers and inspectors.

#### Advantages

It was soon discovered that isometrics could play an important part toward solving this problem. With such a drawing, all workers could easily recognize the parts required in the assembly when the subassemblies were properly prepared and broken down into cycles of fair size. It was simple to read with no explanation required or training necessary for the worker. And, more important than that, as-

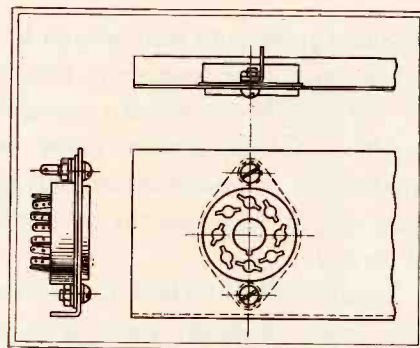
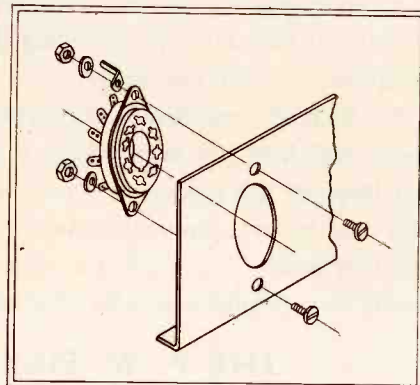

FIG. 1—An orthographic view of a socket and mounting requires three drawings to show the correct order of assembly

FIG. 2—Isometric view of the socket assembly shown in Fig. 1. Visualization of the order of operations is simplified for the assembly-line worker



sembly was mastered more quickly by the individual worker so that a minimum amount of time was required for the breaking-in period. This has resulted in maximum production per worker. It has also eliminated a number of supervisors and, in the event a supervisor was

# LITTON MOLUBE

*the best in High Vacuum*



Litton Molube (Molecular Lubricant), a highly refined vapor pump medium, from carefully selected petroleum base, with high stability and extremely low vapor pressure, is now available in unlimited quantities for immediate delivery at prices that revise former operational economy.

Molube will operate advantageously in practically all equipment designed for organic media. Its complete sorption by activated charcoal makes it ideal for the attainment of ultimate vacuum, but it is equally adapted to ultra speed dynamic systems.

Literature on Litton Molube, High Vacuum Pumps and auxiliaries—glass working fires and machines, and accessories—metal glass seals and special products available on request.

*"For Twelve Years the  
Standard of the Industry"*

# Litton



**ENGINEERING LABORATORIES**

**REDWOOD CITY, CALIFORNIA, U. S. A.**

Magneto Magnetics

Magneto Mechanics

Magneto Acoustics

Magneto Optics

Magneto Thermics

What Do These Mean to the Engineer?

(This is the fourth of four advertisements discussing the major functions of permanent magnets.)

## THE LEAST KNOWN FUNCTION OF PERMANENT MAGNETS

### To Change Apparent Characteristics of Materials

What are the commercial and scientific possibilities in the application of magnetism which changes the characteristics of certain materials whether gas, liquid or solid?

We know, for example, that the application of a magnetic field will cause the following changes:

#### IT WILL CHANGE

- the apparent a.c. permeability of soft magnetic substances
- the normal hysteresis curve of magnetic materials
- the dimensions of nickel and some other metals

- the frequency of a tuning-fork
- the electrical resistance of bismuth
- the boiling point of some materials
- the rotation of polarized light through many materials

These and kindred effects, which are known and are being investigated by physicists, may well lead to new fields for the application of permanent magnets. The potential uses of this little known property of magnetism have been scarcely touched industrially, although it has been employed in magneto stricture oscillators, in remote control indicators and, by the use of bismuth to determine field densities.

Our own research, based upon 35 years of specialization in the manufacture of permanent magnets, may help you to find some new means of achieving desired results. Write for consultation. Without obligation, send for copy of technical handbook: "Permanent Magnets Have Four Major Jobs."

★ THE INDIANA STEEL

6 NORTH MICHIGAN AVENUE, CHICAGO 2, ILLINOIS



PRODUCTS COMPANY ★

SPECIALISTS IN PERMANENT MAGNETS SINCE 1910



## THESE SALES REPRESENTATIVES ARE READY TO SERVE YOU!

### GERBER SALES CO.

94 Portland St.,—Ph. Lafayette 3484  
Boston 14, Mass.  
CONN., MAINE, MASS., NEW HAMP., RH. ISL., VT.

### S. W. SIMBERKOFF

347 Fifth Ave.,—Ph. Murray Hill 5-7090  
New York 16, N. Y.  
N. Y., N. J., PENN., DEL., MD., D. C., VA., W. VA.

### CHAS. H. DOLFUSS, JR.

Film Exchange Building,—Ph. Prospect 0719  
Cleveland 14, Ohio  
OHIO, LOUISVILLE AND LEXINGTON, KENTUCKY

### FRED J. STEVENS

15126 East Warren,—Ph. Tuxedo 11220  
Detroit 24, Michigan  
W8KQC MICHIGAN, INDIANA

### AL KNODELL

5746 North Artesian Ave.,—Ph. Longbeach 9627  
Chicago 45, Ill.  
W9TLQ NORTHERN ILLINOIS

### CLAIR R. MILLER

Ph. 2-3408  
Cedar Rapids, Iowa  
SOUTHERN ILL., MO., KANSAS, IOWA, NEB.,  
9KFA MINN., WIS.

### DALE G. WEBER

7026 S.W. Capitol Highway,—Ph. Cherry 2650  
Portland 1, Oregon  
WASHINGTON, OREGON, IDAHO, MONTANA

### NICKERSON & RUDAT

383 Brannan St.,—Ph. Douglas 8530  
San Francisco 7, Calif.  
NORTHERN CALIF., RENO AND CARSON CITY, NEVADA

### VERN T. RUPP

1150 W. Olympic Blvd.,—Ph. Prospect 9516  
Los Angeles 15, Calif.  
WGFMK SOUTHERN CALIFORNIA

### G. G. WILLISON

West Building,—Ph. M. 2-4553  
Houston 2, Texas  
TEXAS, OKLAHOMA, SHREVEPORT, LA.

### FRANK C. FASSETT

1707 Grand Central Ave.—Ph. H-1976  
Tampa, Florida  
W4BYR FLORIDA

### CAROLINA RADIO EQUIPMENT

105 East Martin St.,—Ph. Raleigh 4842  
Raleigh, N. C.  
WRAL NORTH CAROLINA



Now—General Electronics is proud to announce nation-wide sales representation on its complete line of electron power tubes—nine of which are illustrated above. These representatives have been appointed because of wide acquaintance in territory, knowledge of products, customers' requirements and ability to render excellent service.

In all phases of electronics—induction heating, broadcasting or medical—General Electronics tubes have earned a reputation for extra-long life—the result of advanced design technique and completely modern production facilities and methods.

Wherever you are—whatever your tube requirements—consult the new General Electronics Catalog . . . then communicate with your nearest representative if you need immediate help.

**GENERAL  
ELECTRONICS  
INC.**

# Complete

## DUPLEX DETAILS



### NOW AVAILABLE!

Fresh off the presses, a 12-page bulletin on the new, amazing Duplex Speaker is now available . . . jam-packed with engineering and technical data, performance curves, distribution characteristics. Details of the Dividing Network, A323 Amplifier and attractive cabinets also included.

**SEND FOR YOUR COPY  
TODAY**

# ALTEC

LANSING CORPORATION

1210 TAFT BLDG., HOLLYWOOD 28, CALIF.  
250 WEST 57 STREET, NEW YORK 19, N. Y.  
IN CANADA, NORTHERN ELECTRIC CO.

ISOMETRICS

(continued)

absent, the assembly line was not affected.

Illustrated in Fig. 1 and 2 is a simple assembly in orthographic and in isometric exploded view. In the orthographic view at least two or three views are commonly required to identify the correct order of assembly, whereas in the isometric one drawing is required. Also it has been found that there is more assurance of the parts being correctly assembled by the neophyte worker during the first few hours of breaking-in time.

Isometrics is especially useful in showing wiring of radio parts in the chassis assembly. Figure 3 shows this wiring and when finally

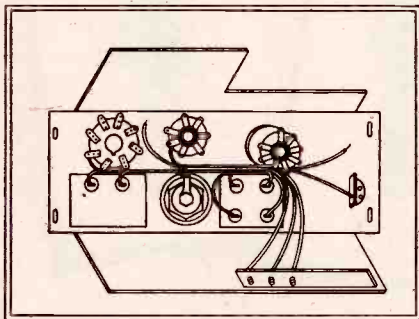

FIG. 3—Chassis wiring in isometric view. Color can be used to show coded wires

printed the wiring is shown in the wiring color markings. Another consideration is the time required for the preparation of the isometric drawing, since a trained draftsman can easily halve the time required to make an orthographic projection drawing.

#### Procedure

A method much in use is for a hudsman or layout man to make a complete layout in isometric of a certain section of the equipment, as in Fig. 4. Then the isometrician's assistants or draftsmen draw the subassemblies from this master drawing. See Fig. 4(a) showing a section of (b). This method of producing drawings has saved considerable time for the drafting departments. Sometimes the subassemblies are reduced in size to accommodate small chart folders, which are placed in front of each assembler with a print of the required assembly to be made.

Three more considerations are

# NOW 8 SIZES OF CREATIVE GROMMETS

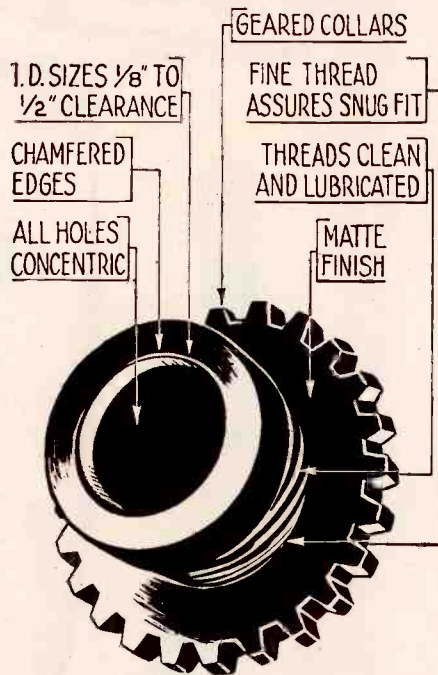

Four new larger sizes of CREATIVE 100% PHENOLIC PLASTIC GROMMETS (up to 1/2" i. d.) are now available for radio, electronic and electric instruments... *Send for a sample of each of the eight standard stock sizes, mounted on a convenient card.*

#### CREATIVE'S CUSTOM SERVICE

You don't have to build molds to get Plastic Parts with Inserts such as knobs, terminals, etc. Get the facts about this unusual custom service . . . **CALL ON CREATIVE.**



*Creative*



**PLASTICS CORP.**

978 KENT AVE. BROOKLYN 3, NEW YORK

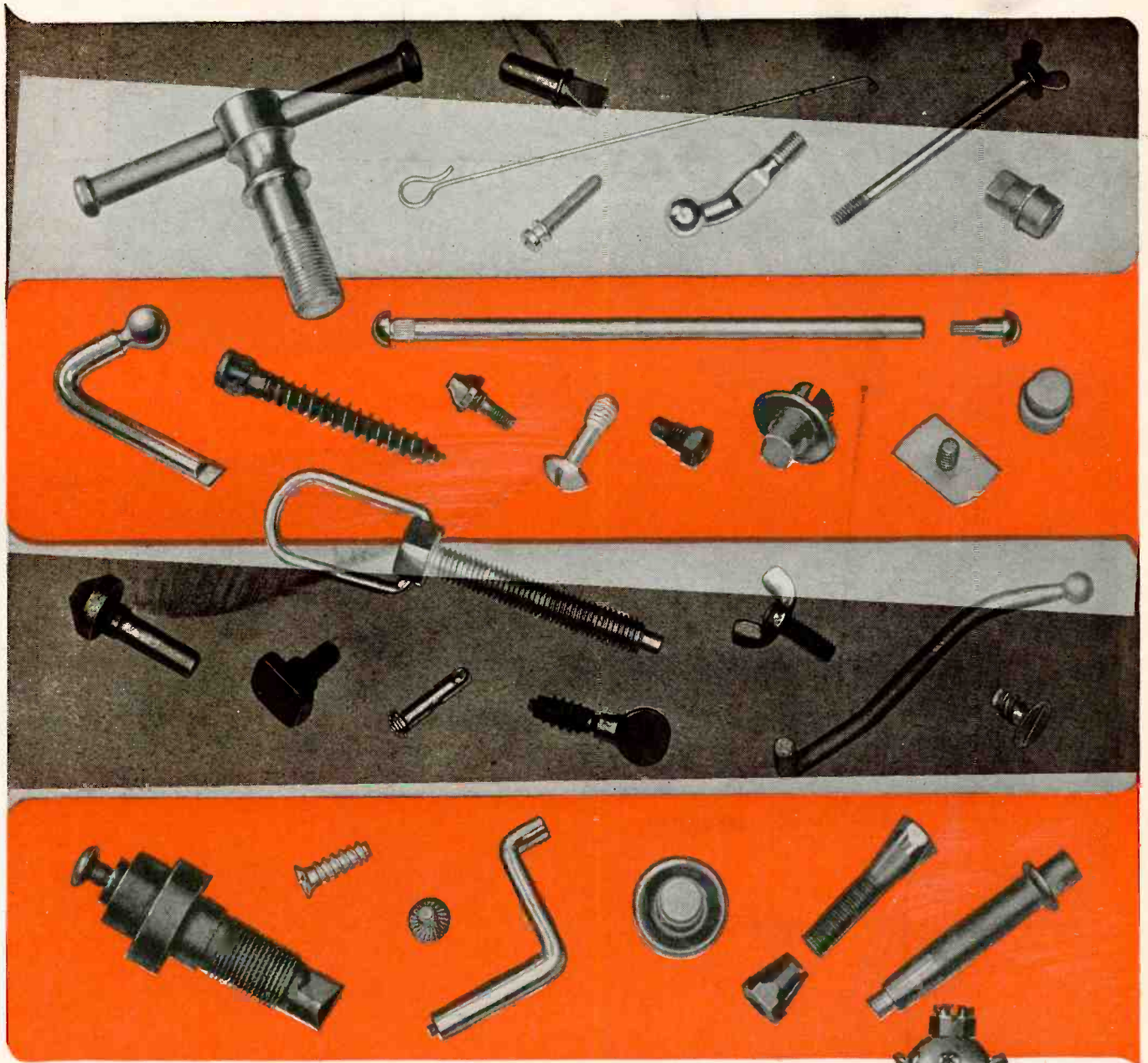

*Yes.* we make "SPECIALS"!

Just take a good look at the picture above—a sample assortment of nonstandard products which we have made by the upset method. Most of these could not have been produced, in the time and quantity required, in any other way.

The upset or cold forging method also saves materials and lowers costs. And in many cases it makes a stronger, better product than that produced by other methods.

Maybe we can show YOU some important SAVINGS. Tough "specials" are right down our alley. Write us.



*National*  
HEADED AND THREADED  
PRODUCTS

THE NATIONAL SCREW & MFG. CO., CLEVELAND 4, O.

Two reasons why Essex  
**EXTRA-TEST** MAGNET WIRE  
is ideal for Coil Winding

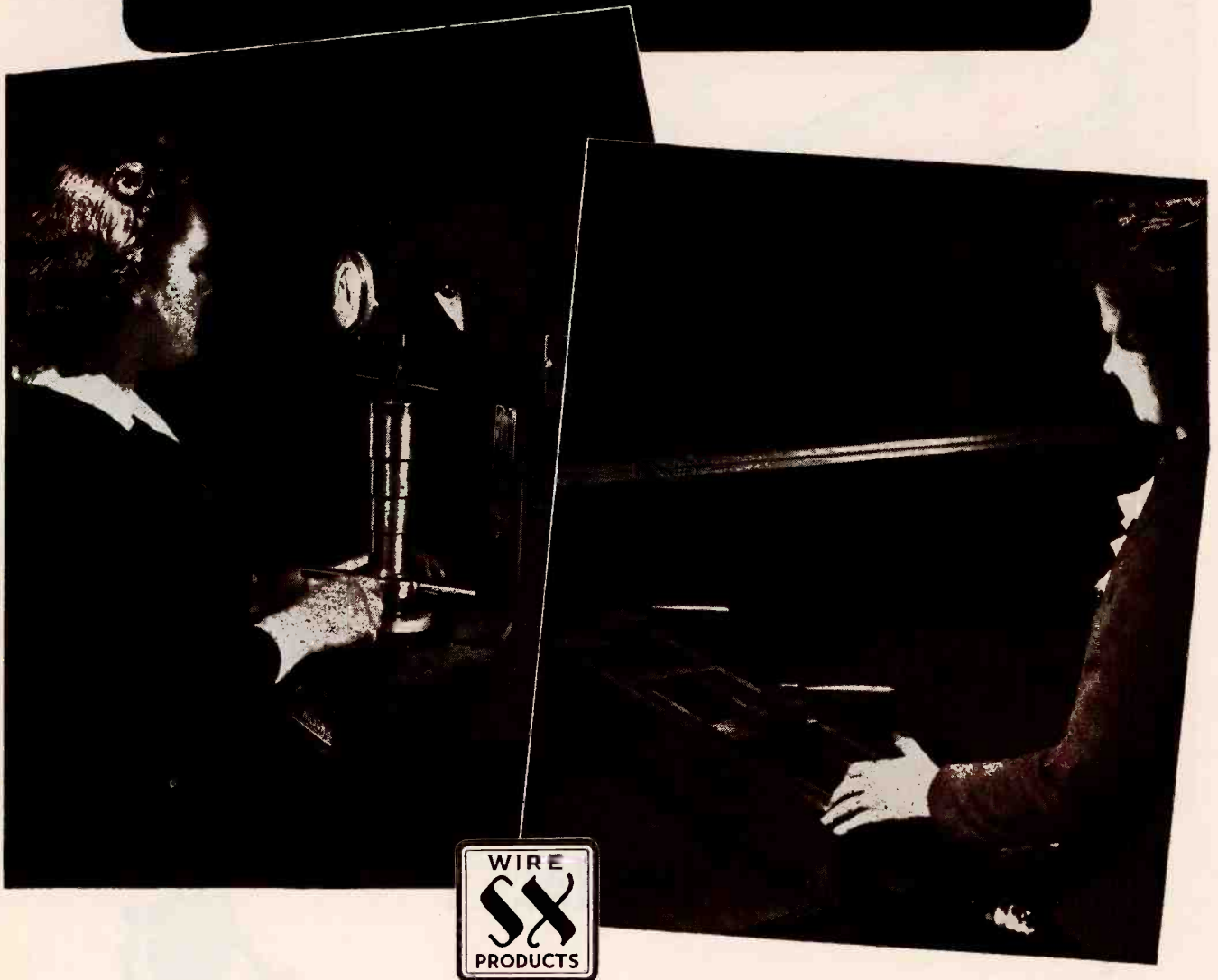

Essex *Extra-Test* Magnet Wire is carefully and thoroughly tested for softness and "stretch" before shipment from the factory.

All flat, square, and heavy round wire is given the Rockwell Test. Round wire in intermediate and smaller sizes is subjected to Elongation Tests. In every case, Essex demands results better than ordinary specifications require.

These constant, severe Essex *Extra-Tests* give definite assurance that every spool of this fine magnet wire will be soft enough—sufficiently annealed for ideal "wind-ability" in coils. No more hard,

springy wire to cause trouble and slow up production. No more annoying complaints and adjustments.

Essex also uses the most modern methods of spooling wire—and all essential data (size, weight, insulation) is plainly indicated on the label of every spool. This prevents costly errors in your warehouse and winding room.

**ESSEX WIRE CORPORATION**  
FORT WAYNE 6, INDIANA

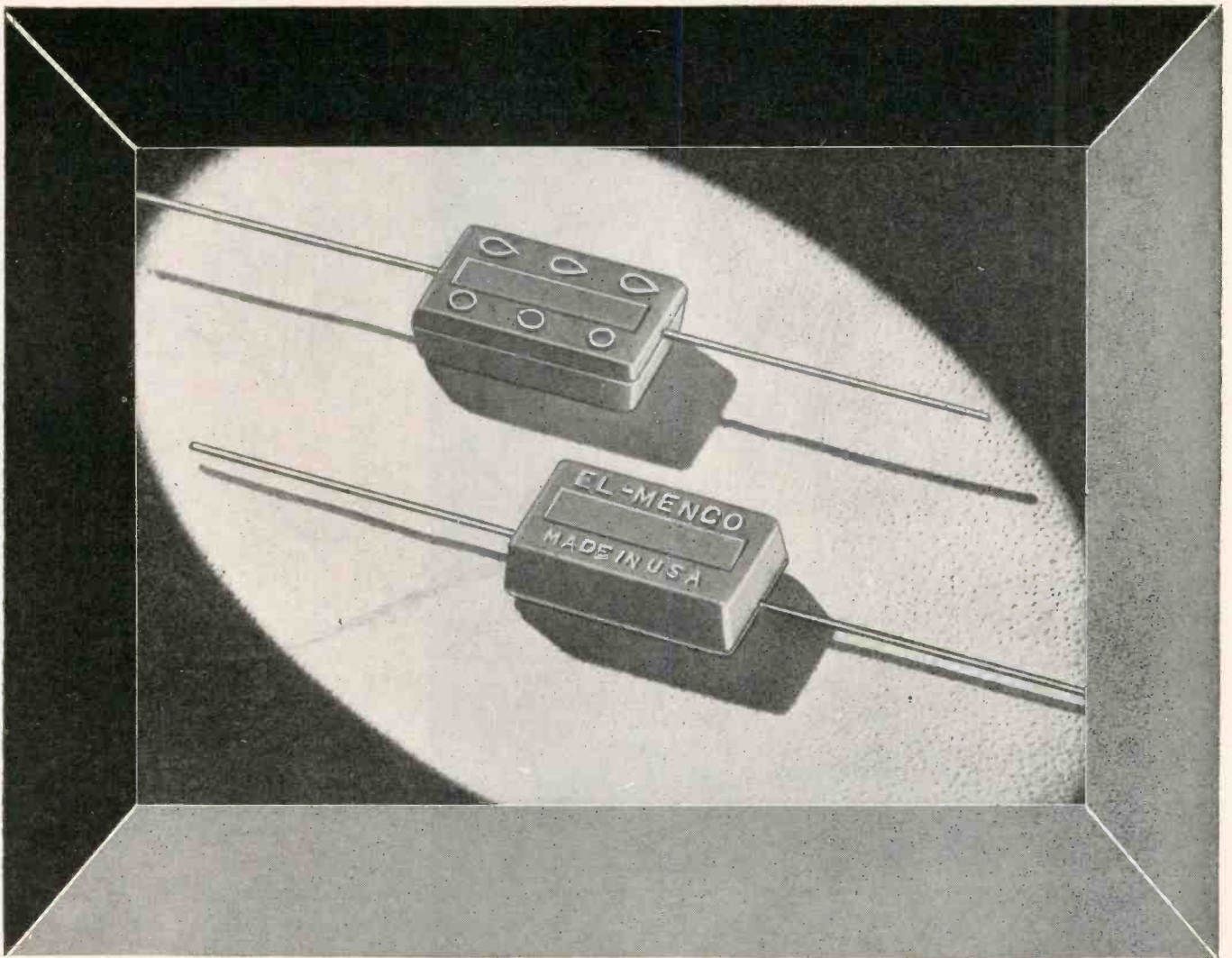

# PORTRAIT OF *Precision*

Precision marks every step in the manufacture of El-Menco Capacitors, for well we know the vital role our products must play, and how much depends upon their unfailing performance. That this precision is appreciated is best evidenced by the Army-Navy award we so proudly display.

Postwar products in which El-Menco Capacitors will be used will undoubtedly be *fine* products — products of quality in every detail.

Manufacturers of  
Electronic Equipment:



Send, on firm letterhead  
for new Capacitor Catalog.

THE ELECTRO  
MOTIVE MFG. CO.

Willimantic, Conn.

**El-Menco**  
MOLDED MICA-  
MICA TRIMMER  
*Capacitors*



Our new booklet  
**"MERIT SALUTES THE  
 SIGNAL CORPS"**  
 with illustrations  
 in four colors  
 is now available

●  
 Please write for your copy.

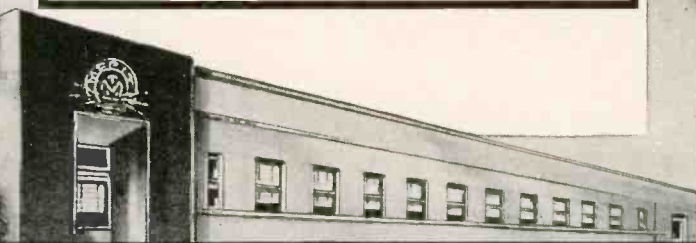

**MERIT COIL & TRANSFORMER CORP.**

TELEPHONE

4427 North Clark St. Long Beach 6311 CHICAGO 40, ILL.

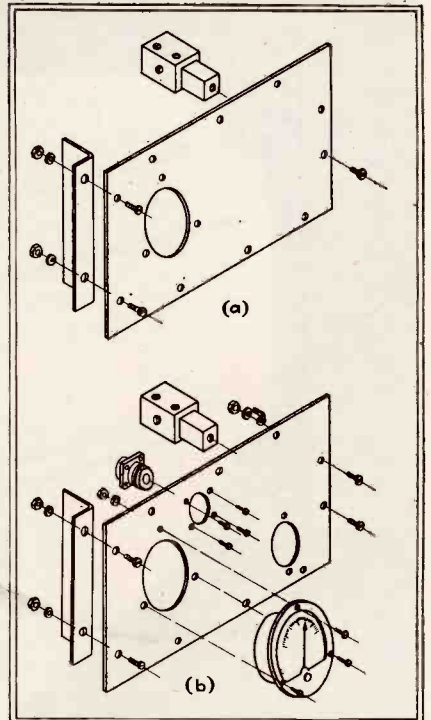

FIG. 4—An isometric layout of a complete panel is shown at (b). From this master, the view at (a) of the sub-assembly is drawn

important. One is that this type of assembly guidance does not tie up many small units used as models in the plant. A second is that, in the event of a change in the part, the isometric drawing revision is much simpler and less costly to make than the model used in the plant. The third is that inspection depart-

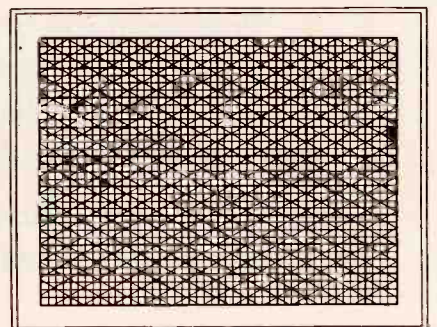

FIG. 5—Cross-ruled sheets can be used as guides if diagonal lines are added for making isometric drawings

ments find it a great deal easier to use than the conventional orthographic assembly blueprints.

The training time for most draftsmen in this type of work is anywhere from about three days to two weeks. The work can generally

A "FIRST" FOR INDUSTRY AND LABORATORY

Potter

TWO-DECADE  
ELECTRONIC COUNTER

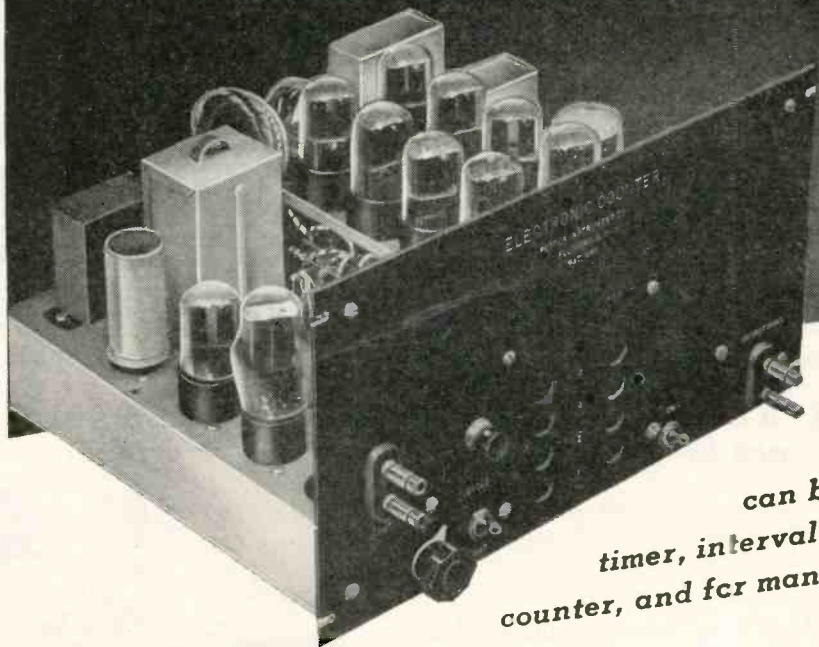

*An instrument that  
can be used as a counter,  
timer, interval controller, radiation  
counter, and for many other applications.*

This new high speed counter eliminates many of the handicaps of commonly used counting methods. Operating at speeds up to 1000 cycles a second, each decade divides by 10, giving a scaling factor of 100. A telephone-type relay, whose contacts close once for each 100 input cycles, is connected to output terminals. An electro-magnetic counter may be added to this output to extend the count to as many places as desired. The Two-Decade Electronic Counter is useful for counting rates exceeding 10 cycles a second, generally too fast for

conventional counters. It may also be used to replace conventional counters that may not stand up under continuous high speed operation. Another use for this instrument is counting and calibration of cycles in resistance welding operations. It may also be used as an interval timer by connecting it through a switch to a known external frequency. Readings are observed in terms of the number of cycles of the known input frequency. The unit can be supplied with switches making it predetermining and useful in control applications.

*The Two-Decade Electronic Counter operates from a 60 cycle, 105 to 125 volt line. It uses 11 tubes.*

Other counter products are—COUNTER CHRONOGRAPHS for measuring projectile velocities to accuracies of one part in 10,000; PRECISION TACHOMETERS that measure engine r.p.m. to a fraction of a revolution; INTERVAL GENERATORS that generate a predetermined time interval from 10 microseconds to 10 seconds in 999,999 steps of 10 microseconds; RADIATION COUNTERS which resolve repetition rates of well over 0.5 microseconds.

INSTRUMENT  
Potter  
COMPANY

ELECTRONIC COUNTER PRODUCTS...  
136-56 ROOSEVELT AVENUE  
FLUSHING, NEW YORK

BUY MORE... HOLD MORE... WAR BONDS

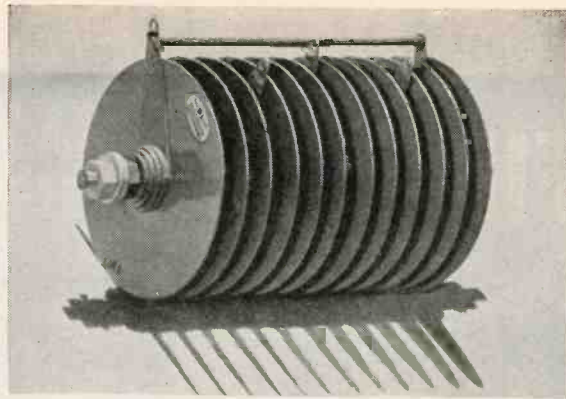

# P

## OWER CONVERSION

*from AC to DC with* **B·L RECTIFIERS**

B-L SELENIUM AND COPPER SULPHIDE ELECTRICAL RECTIFIERS are used wherever direct current is required from an alternating current source. These rectifiers are compact—durable—silent; have no moving parts; are simple to install, require no maintenance. Ratings from milliwatts to kilowatts.

### **B-L RECTIFIER TRANSFORMER ASSEMBLIES** *are built for many standard applications:*

B-L Laboratory Rectopacs for supplying the required voltage of direct current from the alternating current source.

B-L Heavy Duty Portable Railroad Battery Charger, for use in terminals.

B-L Fast Battery Charger for "no removal" automotive battery service.

B-L Battery Booster for use in charging batteries and keeping them charged.

B-L Cathodic Protection for pipe lines.

B-L Filterpacs, eliminating the need of batteries, in operating 6-volt DC electrical equipment.

Consult us if you have a Power Conversion Problem. Twenty-five years of B-L specialized skill in AC-DC conversion problems is available to you. Write for Bulletin R38-A.

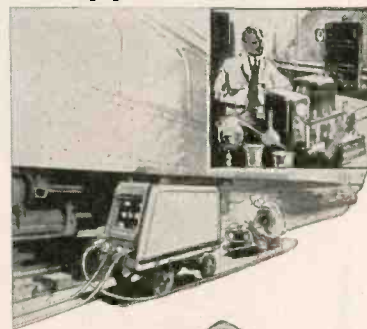

SELENIUM



COPPER  
SULPHIDE

**THE BENWOOD LINZE COMPANY**  
1815 Locust Street • • • St. Louis 3, Mo.  
Long Distance Telephone CEntrol 5830

New York Sales Office:  
420 Lexington Ave.  
New York 17, N. Y.  
Murray Hill 5-5878

Chicago Sales Office:  
20 N. Wacker Drive  
Chicago 6, Illinois  
Telephone CEntral 2379

**Designers and Manufacturers of Selenium and Copper Sulphide Rectifiers, Battery Chargers, and DC Power Supplies for practically every requirement.**





**RIGHT**  
from the  
**START!**

**You'll find WHITAKER is a dependable source —if your production needs include CABLE ASSEMBLIES**

Let specialists who are experts produce the cable assemblies, wiring harnesses or bonding jumpers required in units you manufacture. Turn the job over to Whitaker —and it will be *right from the start*.

Throughout every stage of our production we make exacting inspections, tests and checks. (Illus-

tration above shows positive continuity check of assemblies being made for an electronic manufacturer).

In addition to an engineered wiring service, Whitaker also offers a quality line of standard cable requirements . . . Write us for complete information.



**WHITAKER CABLE CORPORATION**

General Offices: 1307 Burlington Avenue, Kansas City 16, Missouri  
Factories: Kansas City, Mo. • St. Joseph, Mo. • Philadelphia • Oakland

1920--Silver Anniversary--1945

be done from blue prints of assemblies or actual assembled parts.

Since isometric drawings are usually shown at 30-deg angles, a simple chart as shown in Fig. 6 can be prepared to use under the drawing sheet. It is prepared by drawing 64 squares to the square inch (such ruled sheets can be purchased), then diagonal lines are drawn in both directions at 30-deg angles at  $\frac{1}{2}$ -in. intervals. However, there is available on the market a small size ( $8\frac{1}{2} \times 11$ ) prepared isometric chart.

• • •

### Electronic Equipment for Commercial Aircraft

By DAVID WILLIAM MOORE, JR.  
*Fairchild Camera and Instrument Corp.*  
*New York City*

TO BE A PRACTICAL commercial conveyance, or a very useful private one, an aircraft must be capable of sustained operation through areas of limited visibility. This limitation of visibility, to be overcome, presents problems which are not encountered in any other type of vehicle. It was for many years an impossible problem to even determine the actual height above the ground. It still is a nice problem, but one which has been solved at least for large commercial craft by the application of electronics.

When the weather is such that visibility is limited to a very few feet, and no accurate altitude indication is available, no true ground speed and obviously no indication of the plane's exact location, flying can be far from enjoyable. This is just the predicament that flyers found themselves in not many years ago, before the days of radio ranges, automatic radio compasses, absolute altimeters, etc. It is, unfortunately, the state of the private flier even today due to the prohibitive cost of the available electronic aids, and of even the standard mechanical blind flying equipment. As private flying becomes more popular, accurate radio direction finders will undoubtedly approach a cost not much higher than good automobile radios. The radio range is available to anyone with a radio receiver, but radio altitude equipment will not be common on private

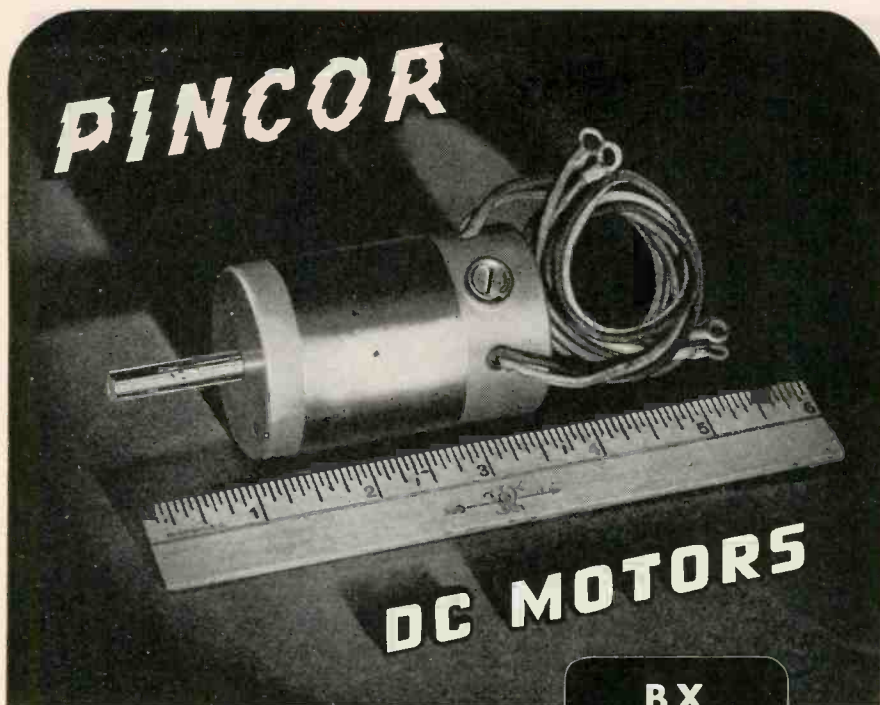

### BX SERIES

The urgent demand, in peacetime days, by the aircraft and radio industries for a compact, efficient D.C. motor was the challenge that led Pioneer to develop the Pincor BX series. Today Pincor BX motors flow from our plant in a steady stream to the producers of aircraft and radio equipment for the armed services.

Pincor BX motors, in their classification, meet the varied requirements of aircraft and radio manufacturers that demand light weight, compact motors for efficient and dependable application. Pincor BX motors are direct drive, ball bearing, high speed units wound for continuous or intermittent duty. Shunt, series or split series windings are for operation on 12 to 24 volt battery systems currently used and may be easily modified to meet your product demand.

Depend on these rugged Pincor quality-proven motors in the BX series. Send your problem to Pioneer engineers and let them put their years of experience to work for you. Consultation with these men will not obligate you in the least.

DYNAMOTORS • CONVERTERS  
GENERATORS  
POWER PLANTS • GEN-E-MOTORS

**PINCOR**  
*Products*

**PIONEER GEN-E-MOTOR**  
CORPORATION

5841-49 DICKENS AVENUE CHICAGO 39, ILLINOIS

BUY MORE BONDS!

Export Office, 25 Warren Street, New York 7, U.S.A.  
Cable Address: Simontrice, N. Y.



# KK

## transformers FOR RADIO-RADAR-ELECTRONIC CONTROLS

Call on Kyle Engineers . . . Trained experts are ready at all times to assist in the design of new transformers to meet your specifications. Write Kyle today.

● Kyle Transformers are the product of one of the leading manufacturers of electric power distribution equipment. ☐ Kyle's unusual facilities for the design and manufacture of precisely built, dependable small transformers have been thoroughly proven in the service of wartime radio communications, radar detection and electronic controls. ☐ Specializing in hermetically sealed equipment of highest quality, Kyle transformers function perfectly under the most extreme conditions of climate and altitude. ☐ Experienced Kyle engineers are anxious to work with you in the design of specific transformers to meet your postwar requirements.



KYLE



CORPORATION

SOUTH MILWAUKEE, WISCONSIN

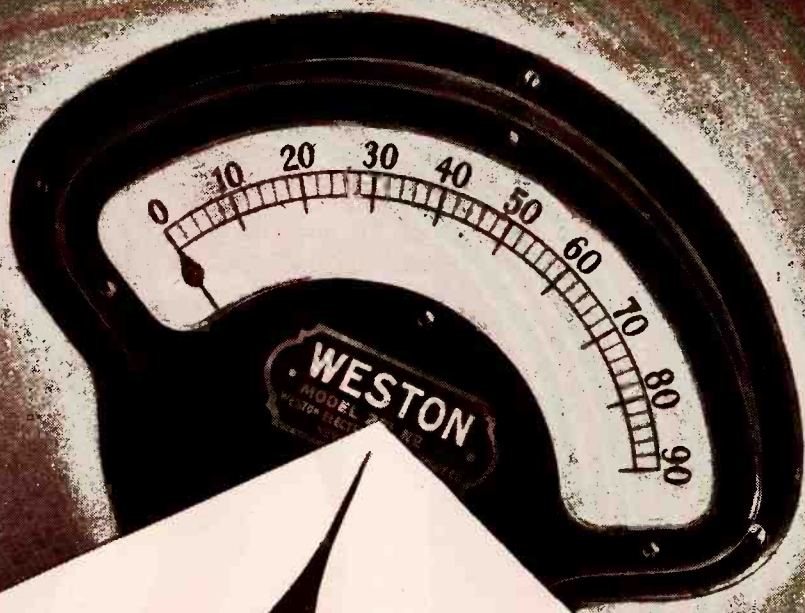

*Pointing the way to*  
**BUYER ACCEPTANCE** *for tomorrow*

Many a brain-child of far-sighted companies now on the drawing-board, is destined for early birth. Tomorrow, these products will be seeking market acceptance not only at home, but in all corners of the earth.

With postwar markets highly competitive, manufacturers will strive to put into the product the best in materials, components, and engineering skill. And if an indicating instrument is essential, it must be one not only of proved dependability, but one which has world-wide preference as well.

Logically, the instrument choice will be WESTON. For a WESTON on the panel gains instant recognition from equipment buyers throughout the world. To them, it is outward evidence of engineering soundness all throughout the device or machine. And to the manufacturer it brings an added sense of security . . . knowing that wherever they are used, his machines have a dependable and trouble free WESTON at the controls.

Before your equipment gets into the manufacturing stage, why not check your instrument needs with WESTON. Complete engineering service is freely offered. Weston Electrical Instrument Corporation, 578 Frelinghuysen Avenue, Newark 5, New Jersey.

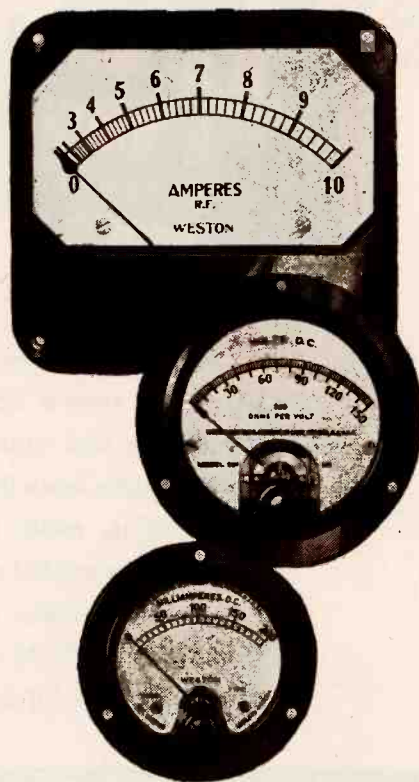

# Weston

ALBANY • ATLANTA • BOSTON • BUFFALO • CHICAGO • CINCINNATI • CLEVELAND • DALLAS • DENVER • DETROIT • JACKSONVILLE • KNOXVILLE • LOS ANGELES • MERIDEN  
MINNEAPOLIS • NEWARK • NEW ORLEANS • NEW YORK • PHILADELPHIA • PHOENIX • PITTSBURGH • ROCHESTER • SAN FRANCISCO • SEATTLE • ST. LOUIS • SYRACUSE

In Canada, Northern Electric Co., Ltd., Powerlite Devices, Ltd.



*In  
War—  
In  
Peace.*

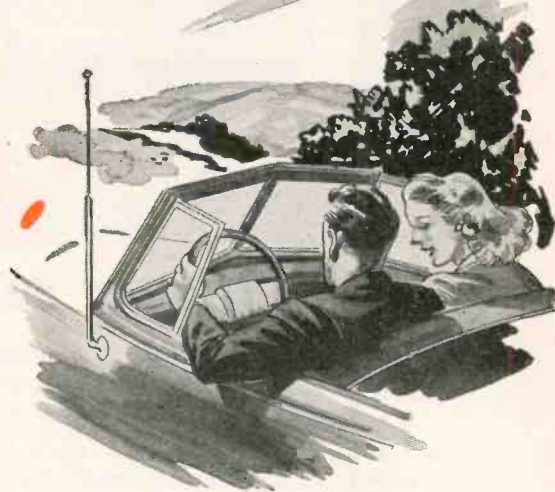

**RADIART VIBRATORS** (INDIVIDUALLY ENGINEERED FOR SPECIFIC NEEDS)  
GIVE *Exceptional Service!*

The high quality of RADIART VIBRATORS is well known. That high quality has characterized all Radiart Products that have been and are being used by the Armed Forces on all fronts. As production for civilian users expands it will continue to increase the demand for RADIART VIBRATORS.

**LIMITED SUPPLY UNTIL V-J DAY**

While production for civilian users may increase gradually, by far the greater part of our production will continue to be required for the U. S. Armed Forces. We must and will meet all of their schedules on time.

**FEWER VIBRATORS TYPES**

By eliminating many little used types of vibrators Radiart has been able to increase production of all popular types. *NOW* the dozen or so types of RADIART VIBRATORS necessary for over 7/8ths of all needs are more readily obtainable.

Radiart Engineers are ready to aid you in adapting or developing RADIART VIBRATORS to meet your specific needs.

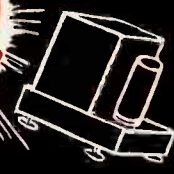

**Radiart Corporation**

3571 W. 62nd STREET • CLEVELAND 2, OHIO  
EXPORT DIVISION: 25 Warren Street • New York 7, N.Y.

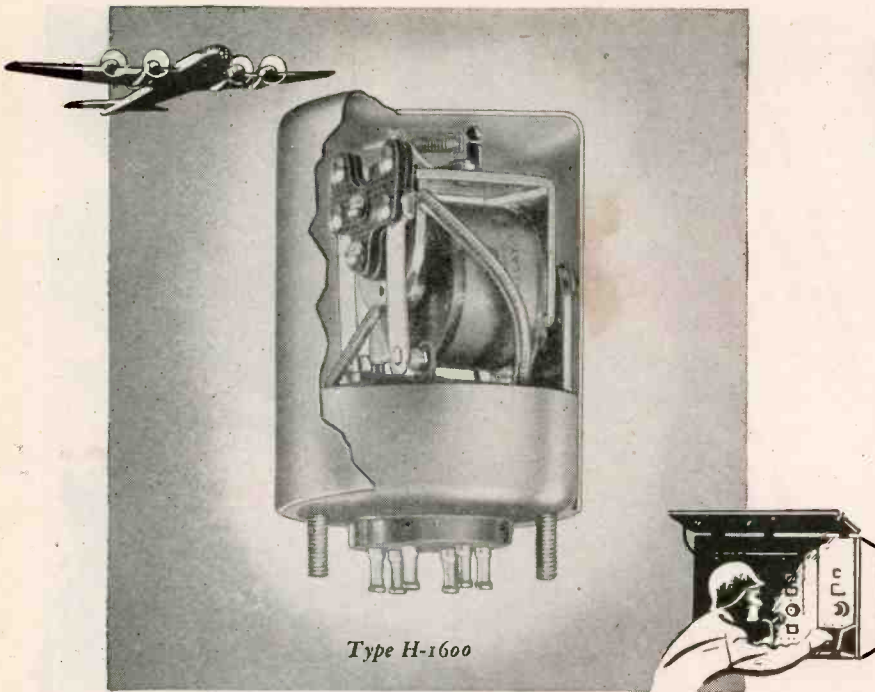

Type H-1600

## HERMETICALLY SEALED

**H**ERMETICALLY SEALED Advance Relays maintain their original efficiency under conditions that soon ruin or dangerously impair other types of relays. Dust, moisture, oil or fungus can't reach the precisely adjusted parts. The low atmospheric pressure of high altitudes can't cause failure through arcing or condensation. That these relays are tamper-proof is another advantage. And basically, like all Advance Relays, they have the stamina to resist the severe shock and vibration of battle, as has been so abundantly proved on all war fronts.

### TYPE H-1600

Double pole, single throw. (May be had in single pole, double throw.) Full-floating armature suspension minimizes friction between frame and armature. Pure silver contacts are standard, with palladium or platinum alloys on special order. Wiping contacts insure clean contact surfaces. All steel parts cadmium plated to withstand the 200-hour Salt Spray Test. All brass and bronze parts nickel plated. All laminated phenolic parts moisture-and-fungus-proofed. Coil is wound with highest grade enamel wire and insulated with 100% cellulose acetate with a final vacuum varnish impregnation. Dimensions are: height of case only, 2"; diameter 1-5/8". Mounting screws and solder lug terminals project 5/16" below case.

Any Advance Relay can be furnished in hermetically sealed containers on special order. When you select Advance, you will have relays exactly as you want them. Our engineers are at your service. Write today for full information.

 **Advance Relays**

**ADVANCE ELECTRIC & RELAY CO.**

1260-1262 W. Second Street, Los Angeles 26, Calif.

planes for quite a while, due to its weight and cost.

### Use for Radar

Radar is furnishing the pilot with the first tangible link with the ground since the conception of mechanical flying. It enables the pilot to definitely contact the ground and to actually "feel" it through his electronic circuits to determine its characteristics, or those of any other object which may be within range of his beam of concentrated radio energy. This is probably the greatest single step forward in aircraft navigation under limited visibility yet to be made. It is at present out of the price range of the private flyer, and probably of most of the commercial airlines, but it has furnished answers to many seemingly unsolvable problems presented to our army in connection with establishing reliable flight routes independent of weather conditions. This type of navigation has been a dream since shortly after the last war, but has become a reality through greatly increased knowledge of microwave technique and of electronic circuit characteristics.

### Ice Indicator

An electronic instrument has been developed to warn the pilot of the formation of ice on his wing surfaces, a very serious problem in cold weather flying. There are so many different forms of ice, and such widely varying rates of ice-creation that satisfactory detection has been and is still difficult. Electrical instruments are being developed in competition with the electronic type. The main problem is to determine the rate of ice formation so that a pilot can, upon changing his course, decide whether conditions have been improved or not.

The formation of wing and tail surface ice has been practically solved on large aircraft, experimentally at least, by the use of heated wings which preclude the possibility of any formation of ice. The propeller and the carburetor are not protected by wing heating and still offer possibilities for electronic detection. But the heated wing will probably never be practical for smaller aircraft where the

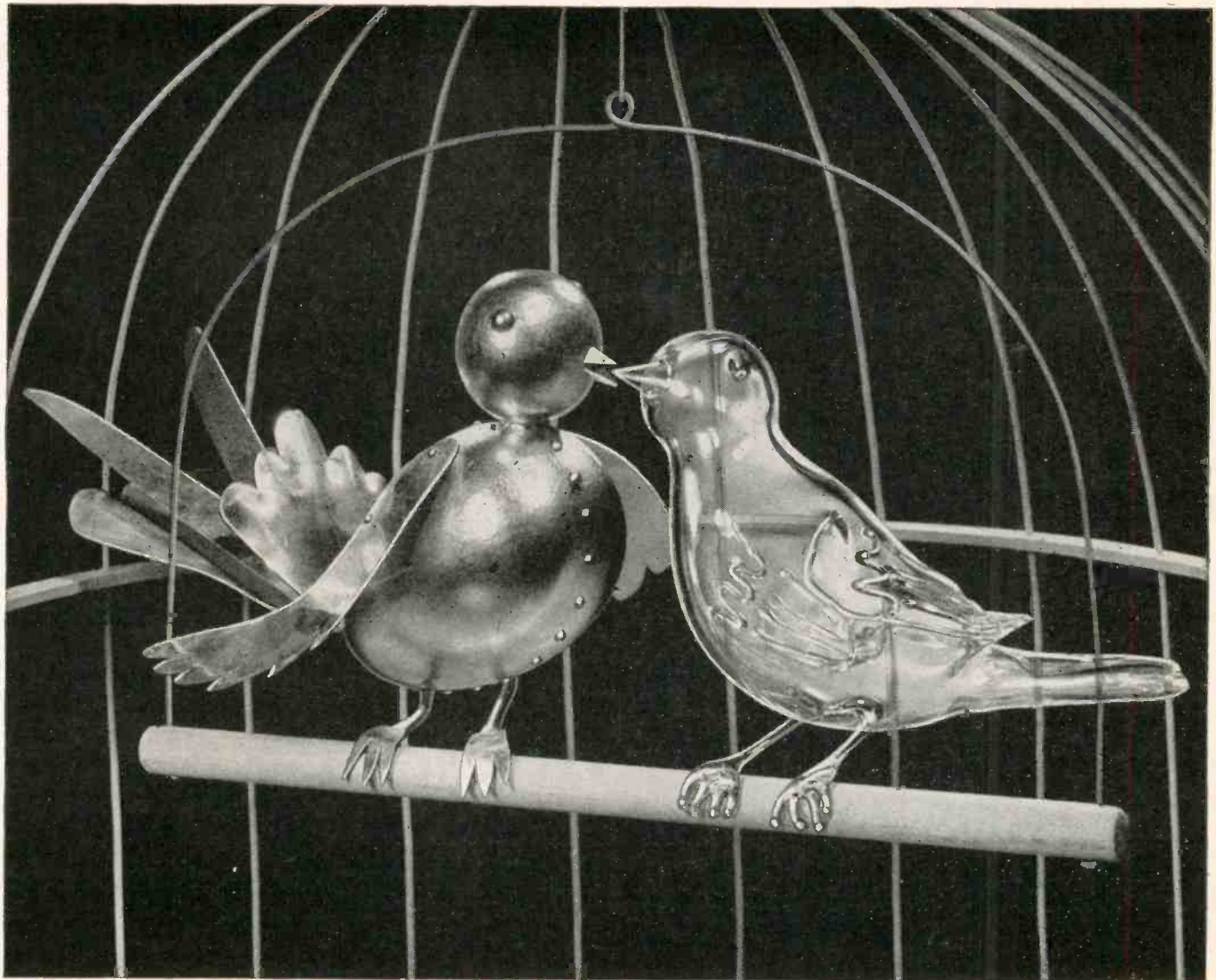

**IT'S THE MATING SEASON FOR GLASS AND METAL . . .**  
*thanks to Corning Metallizing!*

**C**ORNING has long been interested in the mating qualities of glass and metal. Out of this interest has developed a metallizing process which can be accurately *controlled* . . . and which lasts.

Corning's metallizing process, combined with the excellent mechanical and dielectric properties of Corning's glasses, produces hermetic seals between glass components and metal by ordinary soldering

methods or furnishes accurate and constant capacitances and inductances or electrostatic shielding.

Metallized glass as developed by Corning offers a wide variety of new applications in the field of electronics. Perhaps you have a problem where the union of glass and metal can help. Why not write us about it? Address Electronic Sales Department, E-7, Bulb and Tubing Division, Corning Glass Works, Corning, New York.

**CORNING**  
*means*  
**Research in Glass**

**Electronic Glassware**



"PYREX", "VYCOR" and "CORNING" are registered trade-marks and indicate manufacture by Corning Glass Works, Corning, N. Y.

ANOTHER WILCO DEVELOPMENT

**WILCO THERMOMETAL**  
(Thermostatic Bimetal)

# Morflex

**Higher Deflection Rate • Greater Electrical Resistivity**

**This new high action WILCO Thermometal broadens the range of Thermostatic Bimetal application.**

**PROPERTIES AND CHARACTERISTICS**—Morflex provides a 40% higher temperature deflection and electrical resistivity for devices or instruments requiring extremely high sensitivity from 50° to 350°F. Whether the desired function is Temperature Indication, Temperature Control, or Temperature Compensation, Morflex operates dependably and uniformly . . . saves space.

**WIDE APPLICATION FOR DOMESTIC AND INDUSTRIAL DEVICES**—Morflex is supplied in strip or in straight cantilever blades, U-shapes, spirals and helices . . . or as parts of assemblies with shafts, studs, brackets, contacts, braids or springs.

**CONSULT OUR ENGINEERING DEPARTMENT**—Write the WILCO Engineering Department for help in developing the proper application of WILCO materials to your products. Send for **FREE** copy of the WILCO Blue Book. It contains charts, formulae, and full descriptions of *all* WILCO Thermometals and other products:

#### WILCO PRODUCTS INCLUDE:

##### CONTACTS—

Silver  
Platinum  
Tungsten  
Alloys  
Sintered Powder Metal

##### THERMOSTATIC BIMETAL—

High and Low Temperature  
with new high temperature  
deflection rates.

##### PRECIOUS METAL COLLECTOR RINGS—

For rotating controls

##### SILVER CLAD STEEL

##### JACKETED WIRE—

Silver on Steel, Copper,  
Invar or other combinations  
requested.

##### ROLLED GOLD PLATE

##### SPECIAL MATERIALS



**THE H. A. WILSON COMPANY**

105 Chestnut Street, Newark 5, N. J.

Branch Offices: Chicago—Detroit—Los Angeles

**SPECIALISTS FOR 30 YEARS IN THE MANUFACTURE OF THERMOMETALS**

**• ELECTRICAL CONTACTS • PRECIOUS METAL BIMETALLIC PRODUCTS**

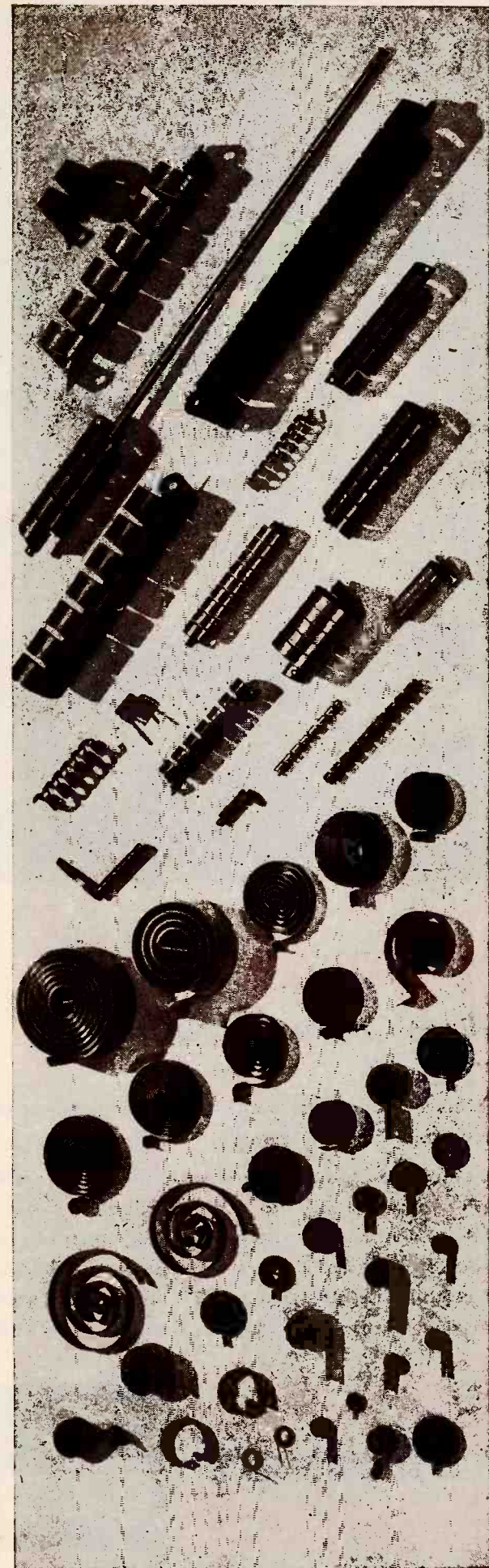



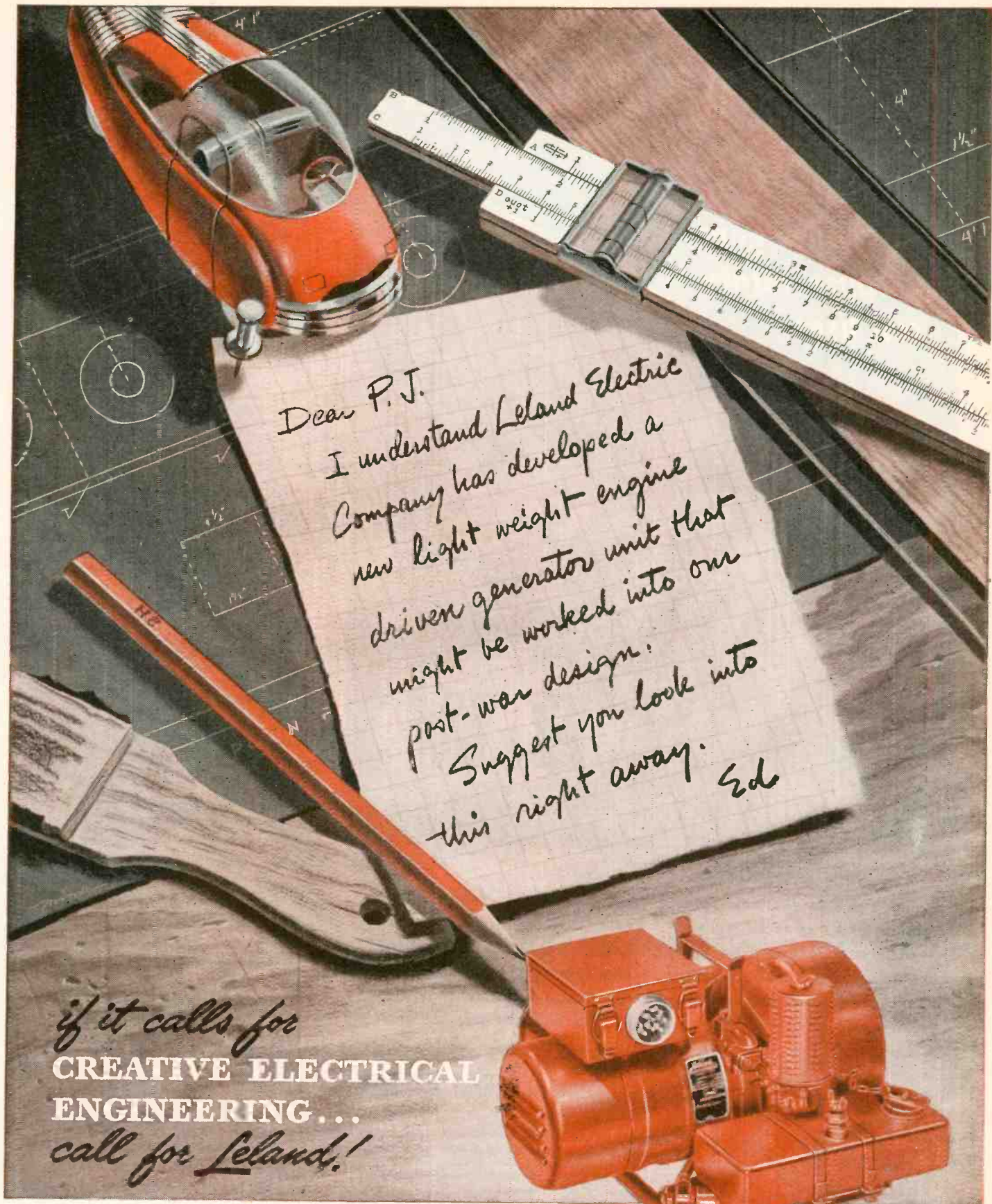

Dear P. J.

I understand Leland Electric Company has developed a new light weight engine driven generator unit that might be worked into our post-war design.

Suggest you look into this right away.

Ed

*if it calls for*  
**CREATIVE ELECTRICAL ENGINEERING...**  
*call for Leland!*

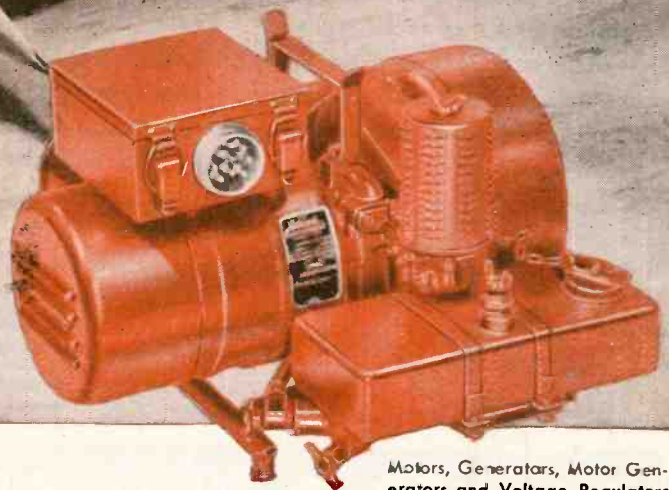

Motors, Generators, Motor Generators and Voltage Regulators

# THE **Leland** ELECTRIC COMPANY



DAYTON, OHIO • IN CANADA, LELAND ELECTRIC CANADA, LTD. ... GUELPH, ONTARIO

# RESISTORS



UNMOUNTED

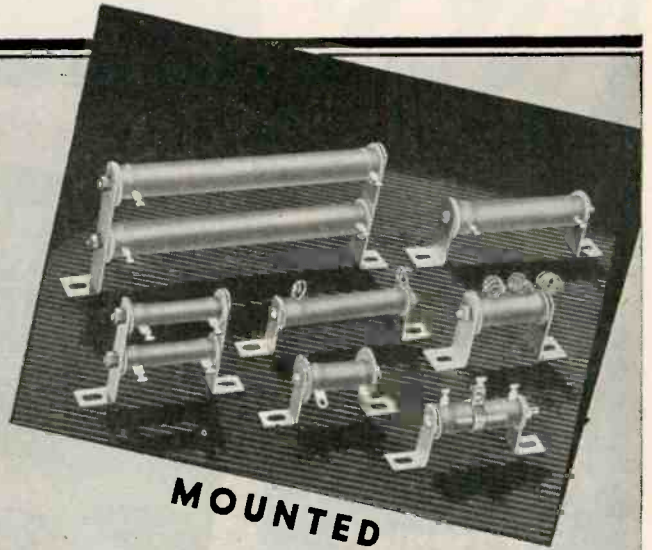

MOUNTED

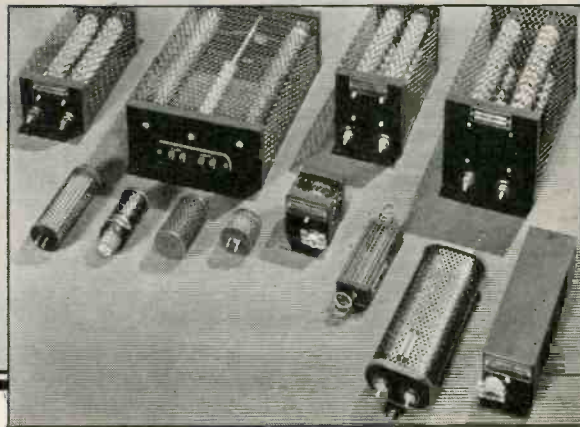

ENCLOSED

THE LINE of Ward Leonard Wire Wound Resistors has been developed through over half a century of meeting the requirements of the electric and electronic industries. The line, therefore, is complete. Ward Leonard not only offers wire wound resistors of every type, size and watt

rating, but also resistor assemblies for usual and unusual purposes. You can find exactly the resistors you are looking for at Ward Leonard.

Send for the New Resistor Handbook. It describes the entire line giving full data on enclosures, mountings, terminals and resistance values.



**WARD LEONARD**  
**RELAYS • RESISTORS • RHEOSTATS**  
 Electric control  devices since 1892

★ ★ ★  
 BUY  
 MORE WAR  
 BONDS  
 ★ ★ ★

WARD LEONARD ELECTRIC COMPANY • 32 SOUTH ST. • MOUNT VERNON, N. Y.



**...WHERE ONLY THE BEST WILL DO**

In a comparatively short time, the mighty bombers of the Army Air Force can pass from the scorching heat of the tropics to the frigid subzero climate of the stratosphere where electrically heated flying suits become an absolute necessity for the protection and efficient operation of all personnel. Vital parts of these "hot suits" are the Durez plastic electrical connectors illustrated here.

Probably no other field of industry requires the versatility in a material as electrical manufacturing. Such properties as dielectric strength, heat resistance, moisture resistance, impact strength and dimensional stability at temperature extremes, are basic "musts" in practically all cases.

Because the phenolics are the most versatile of all plastics, their use in this highly specialized field naturally is tremendous. Typical examples of

this large utilization are these electrical connectors molded for the Holwin Corporation by Northwestern Plastics Company.

#### **Close Tolerances**

As the result of an ingenious molding operation, these electrical connectors are efficiently molded by a single operation. Fastening nut locating holes, as well as spring contact grooves, are molded-in. The specifications call for close tolerances on these grooves which attest to the excellent moldability and exact shrinkage of the Durez phenolic molding compound used. *Further evidence of a plastic that fits the job.*

#### **Versatile Plastic Used**

The wide range of properties which the Durez compound selected for this job possesses, are also found, in vary-

ing degrees, in all of the other more than 300 Durez phenolic molding compounds. In addition to those mentioned before, they possess such properties as lustrous finish, arc-resistance, and resistance to mild acids and alkalis—to mention a few. This unusual versatility makes their applications almost limitless... makes them of unusual value to the design engineer.

As specialists in the production of phenolics for the past quarter century, Durez technicians have the extensive experience so necessary to advise you expertly. The benefits which this rich background and a wealth of proved product development data can provide, are available to you and your custom molder at all times. Durez Plastics & Chemicals, Inc., 327 Walck Road, North Tonawanda, N. Y.



**PHENOLIC RESINS**

**MOLDING COMPOUNDS**

**INDUSTRIAL RESINS**

**OIL SOLUBLE RESINS**

**PLASTICS THAT FIT THE JOB**

# ELECTRONIC AC VOLTMETER

## with Logarithmic Scale

Percentage Accuracy  
of reading is uniform  
over entire scale!

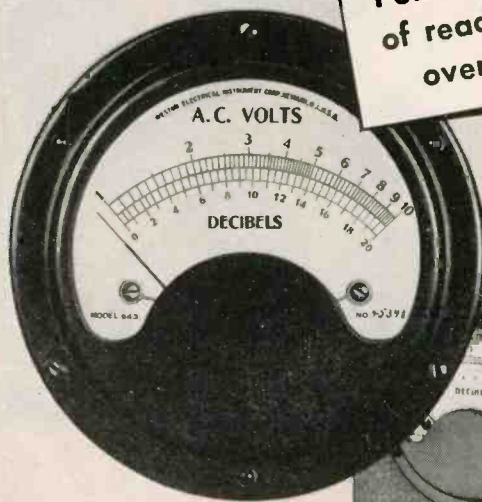

MODEL 300  
ELECTRONIC  
VOLTMETER

### ACCESSORIES

MODEL 220 DECADE AMPLIFIER  
MODEL 402 MULTIPLIER

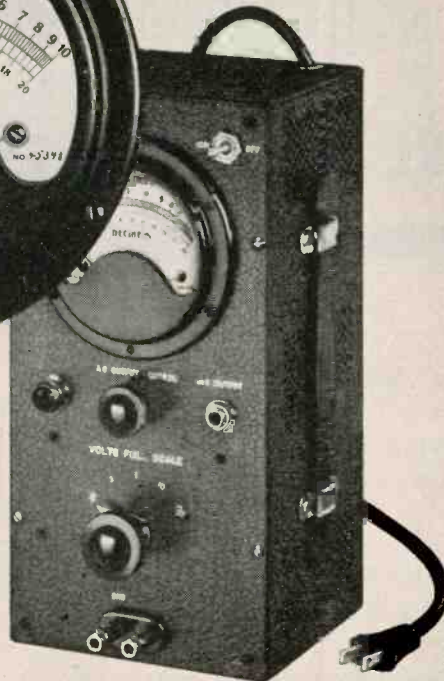

*Since its development in 1935 the Ballantine Electronic AC Voltmeter is the only instrument of its kind with a Simplified Logarithmic Scale.*

The important feature of logarithmic scale indication in the Ballantine Voltmeter provides the same degree of accuracy at 1 as at 10. Also the simplicity of this scale reduces errors in visual observation, common with most multi-range instruments. Finally, the care taken in overall calibration combined with the inherent stability of the circuits used permits reliable readings within the 2% specified tolerance over the complete range of operation.

Write for descriptive  technical Bulletin 8

## BALLANTINE LABORATORIES, INC.

BOONTON, NEW JERSEY U. S. A.

doubtedly be modified to take all engine adjustments away from the pilot, giving him a selection of engine horsepower only. The control will then make all of the necessary engine adjustments selecting the optimum operating conditions for the engine horsepower desired.

### Carburetor Control

A device of this type coupled with the electronic engine-detonation detector which has recently been perfected would enable a control which would automatically lean an engine to the maximum economy consistent with safe engine operating characteristics. In other words, for a given desired horsepower, the control would automatically lean the engine until one or more of the cylinders were detonating and then enrich the mixture slightly until the detonation ceases. Thus, it may be possible to save as much as ten percent of the fuel consumption of an engine operated in the conventional manner.

It is pure conjecture to say whether or not automatic engine controls will be used in the near future on private aircraft. But it is certainly safe to definitely state that if a suitable control at a moderate price were available, it would be used on all planes if for no other reason than for freeing the pilot of any concern over the operation of his engines. In large planes, the saving in fuel alone would pay for the cost of the instrument, and the ease of engine adjustment might free the operators from the necessity of carrying a flight engineer. A very substantial amount of work is now being done on this problem, both along the mechanical and electronic approach.

### Automatic Compass

Completely automatic radio compasses in which the loop constantly and automatically indicates the direction of the desired radio transmitting station are being manufactured in quantity by several concerns. These units will stand up indefinitely under any conditions of operation yet found by our armed forces.

Transmitters and receivers for reliable plane-to-plane and plane-to-ground communication are continu-

# SPEER *Lock Notch*\* COIL-WINDING FORMS



\*SPEER LOCK NOTCH COIL-WINDING FORMS ARE FULLY PROTECTED UNDER U. S. PATENT NO. 2,355,611.

... *assure* **GREATER PRODUCTION,**  
**LESS SPOILAGE—IMPROVED QUALITY!**

For manufacturers of coils, R. F. Choke coils and wire-wound resistors, the small, inexpensive SPEER Lock Notch Coil Winding Forms provide a solution to several production and quality problems. The patented SPEER Lock Notch molded into each end of the coil winding form holds the coil end firmly in place before, during and after soldering. No accidental unwinding—no lost production time—no spoilage—no changes in impedance. After winding, any finish can be applied or the unit covered with molding compound in standard injection molds. It pays to investigate. Perhaps there's a saving!



SEND FOR a sample card displaying standard units. Please use company letterhead and indicate your title.

## WINDING FORM SPECIFICATIONS

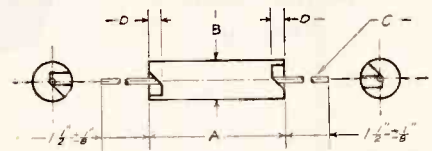

Part No.	A	B	C	D
CF-107	$\frac{3}{8} \pm \frac{1}{32}$	.107 ± .005	.025	.040
CF- $\frac{1}{8}$	$\frac{1}{2} \pm \frac{1}{32}$	.125 ± .005	.025	.040
CF- $\frac{3}{32}$	$\frac{1}{2} \pm \frac{1}{32}$	.156 ± .005	.028	.040
CF-170	$\frac{3}{4} \pm \frac{1}{32}$	.170 ± .005	.028	.030
CF-178	$\frac{3}{4} \pm \frac{1}{32}$	.178 ± .005	.028	.062
CF- $\frac{3}{16}$	$\frac{3}{4} \pm \frac{1}{32}$	.187 ± .005	.028	.062
CF- $\frac{1}{4}$	$1 \pm \frac{1}{32}$	.218 ± .005	.035	.070
CF- $\frac{1}{4}$	$1 \pm \frac{1}{32}$	.250 ± .005	.035	.070
CF- $\frac{3}{8}$	$1\frac{1}{2} \pm \frac{1}{32}$	.375 ± .005	.040	.070

**SPEER RESISTOR CORPORATION** ST. MARYS PENNA.

ONLY  VACUUM CAPACITORS  
 give you the precise  
 capacitance value  
 you want

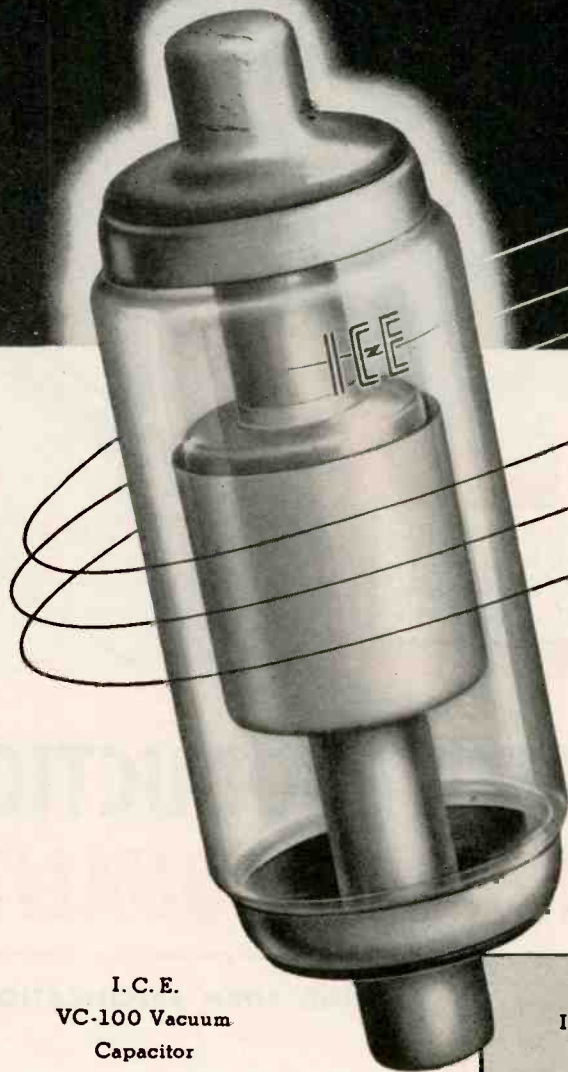

I. C. E.  
 VC-100 Vacuum  
 Capacitor

Now I. C. E. makes it possible for you to order vacuum capacitors with the correct capacitance value to meet requirements of your equipment. I. C. E. Vacuum Capacitors are now available in any value range from 6 to 110 mmfd. in steps of 1 mmfd.

**I. C. E. Vacuum Capacitors Give You Close Tolerances**

Beside offering you a wide range of capacitance values, I. C. E. Vacuum Capacitors are built to give you previously unobtainable tolerances.

**I. C. E. PRECISION GRADE VACUUM CAPACITORS**

Value Range	Accurate to
6 mmfd. to 25 mmfd.	$\pm 0.5$ mmfd.
26 mmfd. to 60 mmfd.	$\pm 1.0$ mmfd.
61 mmfd. to 110 mmfd.	$\pm 1.5$ mmfd.

**I. C. E. XX GRADE VACUUM CAPACITORS**

Value Range	Accurate to
6 mmfd. to 25 mmfd.	$\pm 0.2$ mmfd.
26 mmfd. to 60 mmfd.	$\pm 0.3$ mmfd.
61 mmfd. to 110 mmfd.	$\pm 0.5$ mmfd.



ELECTRONIC TUBES

RESEARCH • DESIGN • PRODUCTION

**Full Details in the New I. C. E. Catalog**

For full information on these outstanding I. C. E. Vacuum Capacitors, as well as other precision I. C. E. products, write today for the new I. C. E. Catalog.

**INDUSTRIAL & COMMERCIAL ELECTRONICS**

BELMONT, CALIFORNIA • NEW YORK CITY, N. Y.

**SOUND EQUIPMENT - precisionized - mechanically and electronically - for finer performance**

Fairchild  
Transcription Turntable

Fairchild Lateral  
Dynamic Pickup

## 25 GRAM 'FLOATING' PRESSURE

*Further Reduces Distortion and Record Wear*

**FAIRCHILD** offers an unusually mounted 'floating' design for low-pressure, dynamic pickup. Designed for radio broadcast and other exacting transcription requirements, it reproduces all of the quality and natural beauty of recorded music or speech *with full naturalness*.

All microscopic undulations — that determine the quality of the transcription — are picked up without distortion *even from heavily modulated grooves*.

How? By means of several Fairchild patented design features: Let's start with

the 3 ounce cartridge mounted on a two-point suspension in the pickup head casting. It's the only vertical moving mass in the Fairchild assembly. High and low spots in the record disc need only displace its 3 ounce weight instead of the total weight of the entire mounting arm. This unusual mounting method affords a near-uniform stylus pressure of 25 grams — even under unfavorable playing conditions.

Next, the pickup head is mounted in the famous Fairchild tone arm with cone ball bearings. Lateral drag is reduced. And

still another important source of distortion and record wear is eliminated.

Finally, there is no *overhang* of the tone arm with consequent inertia — another cause of difficulty when playing warped records or on uneven turntables. The tone arm *floats* at any required adjustable height above the disc.

Descriptive and priority data on the newly perfected Fairchild Lateral Dynamic Pickup and Transcription Turntable are now available. Address *New York Office*: 475 - 10th Avenue, New York 18; *Plant*: 88-06 Van Wyck Blvd., Jamaica 1, N. Y.



*Fairchild* CAMERA  
AND INSTRUMENT CORPORATION

**SOUND  
EQUIPMENT**





FIGURE THIS ONE OUT . . .

# HARDLY ANYTHING IS MORE USEFUL THAN ALMOST NOTHING

Webster defines high vacuum as space almost devoid of content—hence almost nothing.

Almost nothing (high vacuum) has played an important part in manufacturing or processing: electronic devices, light bulbs, dried blood plasma, and countless other products.

# KINNEY HIGH VACUUM PUMPS

For nearly two decades, Kinney has supplied reliable vacuum pumps. In many industries, Kinney Vacuum Pumps have removed high vacuum processing from the laboratory to large scale factory production. Today, nearly three thousand Kinney Pumps are at work in electronics, over two thousand in electrical production and thousands more in metals, petroleum, pharmaceutical, chemical and miscellaneous industrial applications. These vacuum pumps, with a total displacement of over 710,000 cubic feet per minute, represent a vast fund of experience in designing and building pumps for the specialized service of creating and maintaining low absolute pressures.

Let Kinney figure out your vacuum pumping problems

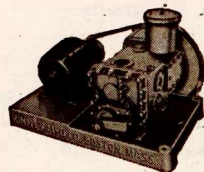

Model CVD Compound Dry Vacuum Pump. Low absolute pressures 0.5 micron or better.

## KINNEY MANUFACTURING COMPANY

3565 Washington Street Boston 30, Mass.  
NEW YORK • CHICAGO • PHILADELPHIA • LOS ANGELES • SAN FRANCISCO

We also manufacture Vacuum Tight Valves, Liquid Pumps, Clutches and Bituminous Distributors

ally being improved. A good transmitter and receiver will be almost a must in post-war private flying if any cross-country flight is anticipated. Both transmitters and receivers as well as radio direction finders in more simple form will be available to private flyers and will probably be similar in construction to high-grade automobile radio equipment, and similarly priced.

### Filters for Electronic Equipment

By GERSHON J. WHEELER

MANY MODERN INDUSTRIAL electronic devices and auxiliary units are sources of r-f noise covering a wide range of frequencies. As such they interfere with radio communications in all bands. This interference is picked up by the antenna of the receiver or is fed back into the power lines. If the noise generator is in a well-shielded box, then power-line filters should eliminate the interference.

There are a few practical precautions which are not mentioned in

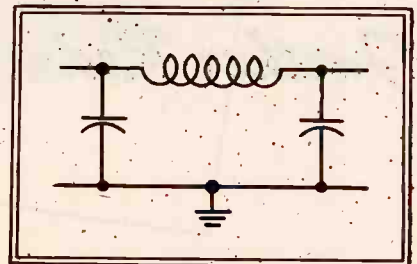

Fig. 1—Popular pi-type of filter under discussion.

the textbooks. Most filters for this application are broadband pi-type configurations consisting of two capacitors and a choke (Fig. 1). Although the larger the choke, the higher will be the attenuation, care must be taken not to make this too large. If the reactance of the choke at the line frequency is too high, the resultant voltage drop would prevent the equipment from operating properly. For example, a 250-microhenry choke in a 110-volt, 800-cycle line (this is not an uncommon line frequency today) would have a reactance of  $1\frac{1}{2}$  ohms. If the equipment draws 20 amperes, the drop across the choke would be 25 volts.

In a-c circuits, and especially at



# NOTHING LOCKS LIKE A SPEED NUT

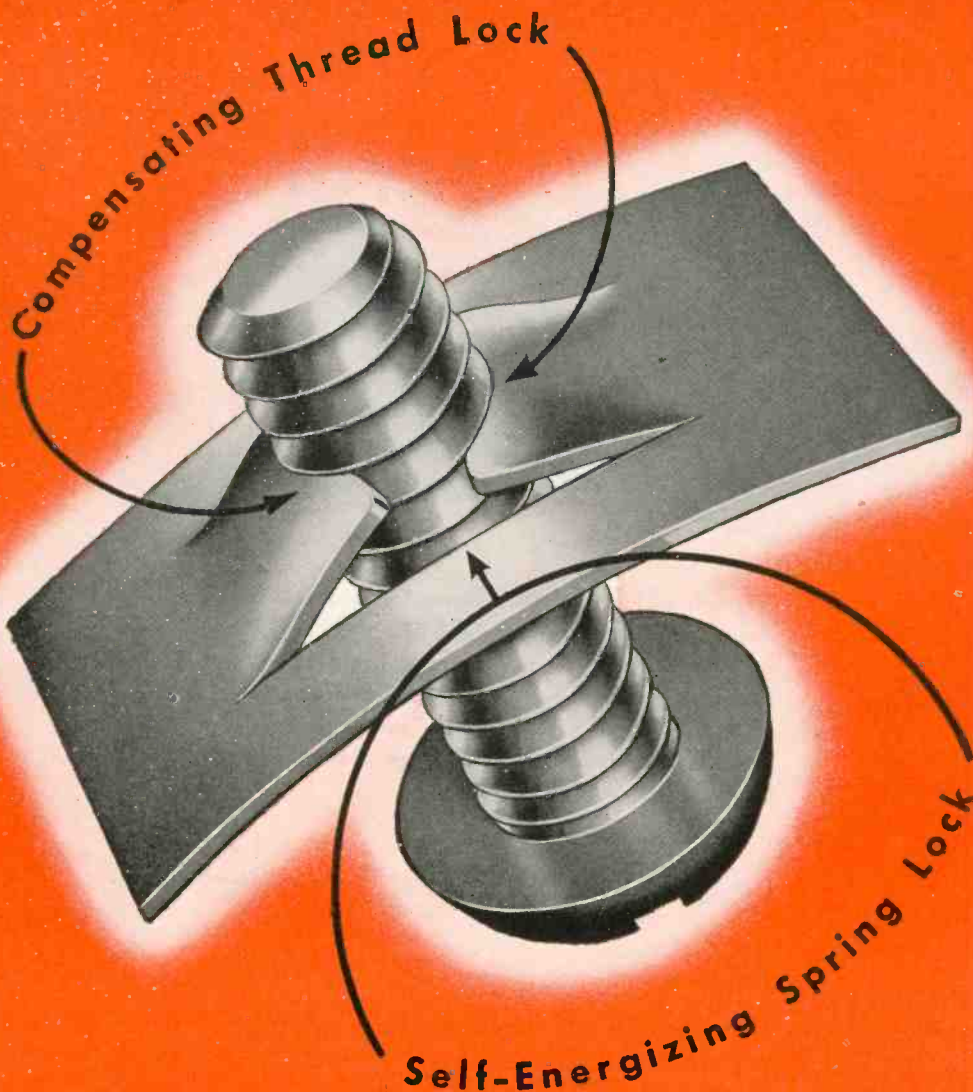

**SPEED NUTS** are the only fastening devices that provide a **COMPENSATING** thread lock and a **SELF-ENERGIZING** spring lock. **TWO** distinct forces are exerted on the screw, as the **SPEED NUT** is tightened.

First, a compensating thread lock, the two arched prongs moving inward to engage and lock against the root of the screw thread. These free-acting prongs compensate for tolerance variations, and function perfectly on oversize or undersize screw or bolt threads.

Second, a self-energizing spring lock, created by the compression of the arch in both the

prongs and base. The combined forces of the thread lock and spring lock definitely eliminate vibration loosening.

**SPEED NUTS**, proven in pre-war commercial industry and now boosting the production of airplanes, are ready to assist you in the assembly of post-war metal, vitreous enamel, plastic or wood products. Literature is available on over 3000 shapes and sizes, for standard or special assemblies.

**TINNERMAN PRODUCTS INC.**  
2106 Fulton Road  
Cleveland, Ohio

*Speed Nuts* 

PATENTED

\* Trade Mark Reg. U. S. Pat. Off.

**FASTEST THING IN FASTENINGS**

# Hermetic Sealing Demands Top-Quality Components

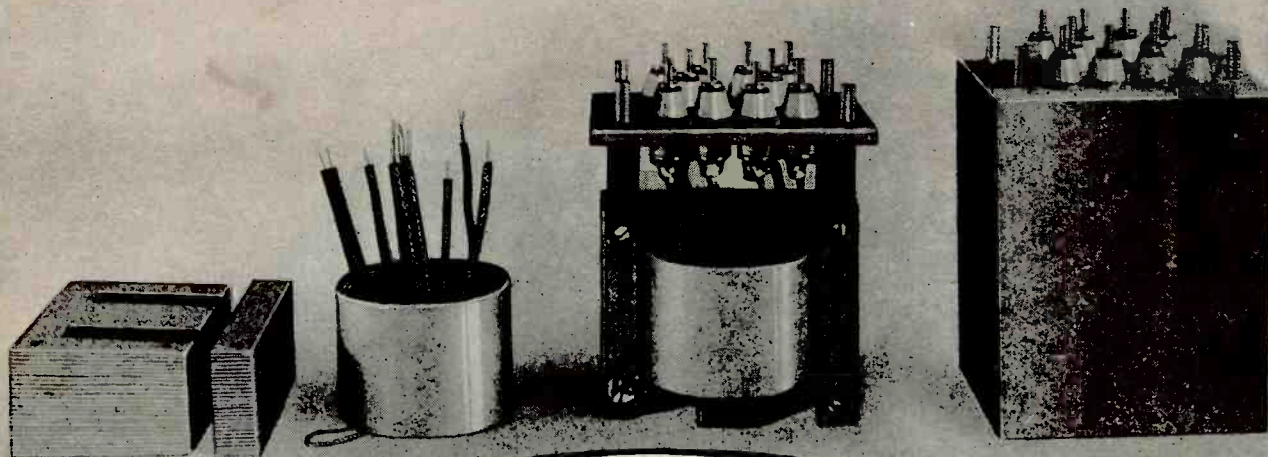

*Hermetically sealed transformer manufactured by Acme Electric & Mfg. Co. of Cuba, N. Y. . . . Part-by-part assembly view shows E-lamination and I-lamination stacks; assembled coil, insulated with Natvar VC, and with Natvar sleeving on all leads; complete chassis; and completed transformer in hermetically sealed case.*

Acme builds transformers to pass the rigid Navy 5 cycle immersion test for hermetically sealed units. Because they are used on important equipment for the Armed Forces, it is essential that quality material be used throughout. *These transformers dare not fail!*

And so every precaution is taken to see that the internal components are far above the standards acceptable for ordinary service. Natvar VC and Natvar sleeving are used because they consistently meet the requirements.

What about your requirements? Write, wire or phone us for deliveries, either from nearby wholesaler's stock, or from our own.



- Varnished cambric — straight cut and bias
- Varnished cable tape
- Varnished canvas
- Varnished duck
- Varnished cellulose acetate
- Varnished special rayon
- Varnished Fiberglas cloth
- Varnished papers
- Varnished tubings and sleeving
- Varnished identification markers
- Lacquered tubings and sleeveings
- Extruded vinyl tubing
- Extruded vinyl identification markers

Write for Catalog No. 20

## THE NATIONAL VARNISHED PRODUCTS

TELEPHONE  
RAHWAY 7-2171

CABLE ADDRESS  
NATVAR: RAHWAY, N. J.

*Corporation*

201 RANDOLPH AVENUE ★ WOODBRIDGE NEW JERSEY

7-NVP-5

# speed plywood bonding WITH RF heating

HIGH FREQUENCY HEATS  
2560 CU. IN. IN 5 MINUTES

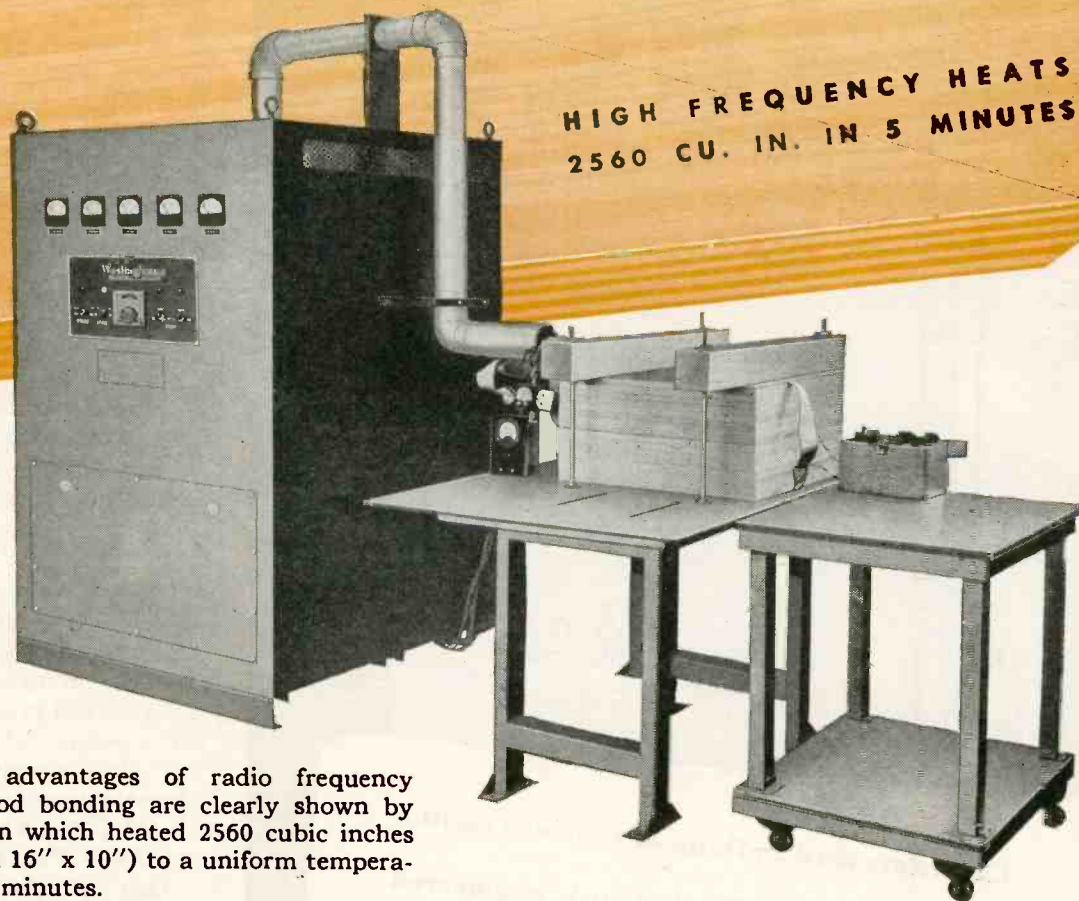

Illustration shows laboratory set-up.

The amazing advantages of radio frequency heating in plywood bonding are clearly shown by this demonstration which heated 2560 cubic inches of plywood (16" x 16" x 10") to a uniform temperature of 270° in 5 minutes.

This is typical of the fast, accurate performance of radio frequency heating. And these compact, easily-installed Westinghouse RF Generators offer many advantages in all types of plywood bonding.

Timing is automatic, for example, and heat after heat can be repeated automatically without interruption, or duplicated in any future job with perfect accuracy. Pushbutton operation is quick and easy and once the Westinghouse heating unit is adjusted to a process, operation merely requires pushing a button and setting dials to calibration data.

RF heating cuts processing costs, too, for power consumption is limited to the amount needed for the operation. The line of Radio Frequency Generators similar to that shown here has wide flexibility in plywood bonding. Operators are protected by dead-front construction.

Your nearest Westinghouse office can give you complete details on the use of radio frequency heating in bonding plywoods. Or write Westinghouse Electric Corporation, P.O. Box 868, Pittsburgh 30, Pa.

J-03107

## Westinghouse

PLANTS IN 25 CITIES . . . OFFICES EVERYWHERE

*Electronics at Work*



# WORLD FAMOUS OSCILLOSCOPES by DUMONT

Use Capacitors by  
**INDUSTRIAL CONDENSER CORP.**



Capacitors used in Dumont's famous oscilloscopes are especially designed, engineered and manufactured for unusual performance under difficult operating conditions.

PAPER, OIL AND ELECTROLYTIC CAPACITORS

**INDUSTRIAL  
CONDENSER  
CORPORATION**

1725 W. NORTH AVE., CHICAGO 22, U. S. A.

DISTRICT OFFICES IN PRINCIPAL CITIES  
QUICK DELIVERY FROM DISTRIBUTOR'S STOCKS

line frequencies greater than 60 cycles, care must be taken not to use large capacitors. If the capacitive reactance of the capacitor is too small, the power source may be called upon to deliver more current than it is capable of handling.

Care must also be taken to prevent resonance at a frequency within the rejection band of the filter. The coil and second capaci-

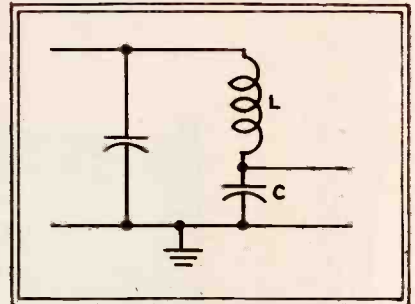

Fig. 2—Redrawing a pi-network shows the resonant circuit formed by L and C

tor form a series-resonant circuit (Fig. 2) and, at the resonant frequency, a high r-f voltage may be developed across the capacitor.

#### Effect of Poor Ground

These problems in design vanish if readily available commercial filters are used, but there still arise problems in installation. The filter must be well grounded. If there is an impedance of any type between the filter ground connection and the actual ground, r-f energy will be fed through the filter back into the line. (Fig. 3).

Lastly, it is important to shield the input of the filter from the output. If this is not done, the un-

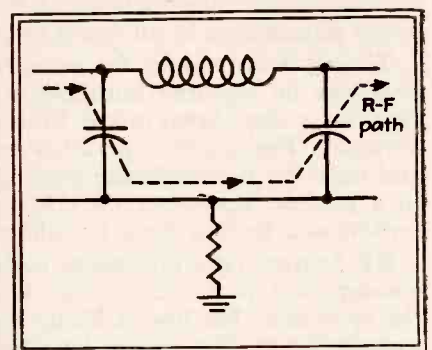

Fig. 3—Passage of r-f current through a filter when the unit is connected to a poor ground

filtered portion of the line will radiate and this radiation will be coupled into the filtered side.



\* Ceramicon is the registered trade name of silvered ceramic condensers made by Erie Resistor Corporation.

ALMOST a decade has passed since the need for extremely stable capacitors with dependable operating characteristics led Erie Resistor to develop and introduce Ceramicons\*. These silvered ceramic condensers immediately found wide acceptance throughout the entire communications field.

Augmented by the tremendous requirements of war, millions of Ceramicons, subjected to the severest service tests, have proved unexcelled in dependable performance, particularly as general purpose condensers, where a moderate degree of capacity change with temperature is permissible.

As general purpose condensers Erie Ceramicons have proved superior to other types of condensers in a great many applications. For example, Ceramicons

are ideal as coupling condensers, particularly plate to grid, where high insulation resistance is of paramount importance.

Ceramicons may be selected from any one of 10 standard temperature coefficients, ranging from P120 to N750.

The capacity range for equivalent physical size is given in table above. We will gladly send you samples of Erie Ceramicons for your general purpose applications.

CHARACTERISTICS

CAPACITY RANGE IN MMF	JAN-C-20 STYLE	ERIE STYLE	MAXIMUM OVERALL DIMENSIONS
1 to 51	CC20	A	.200 x .400
	CC21	K	.250 x .562
52 to 110	CC25	B	.200 x .656
	CC26	L	.250 x .812
111 to 360	CC35	C	.265 x 1.125
	CC36	M	.340 x 1.328
361 to 510	CC40	D	.375 x 1.110
511 to 820	CC45	E	.375 x 1.560
821 to 1100	CC45	F	.375 x 2.00

★  
Buy More Bonds  
★

Electronics Division

**ERIE RESISTOR CORP., ERIE, PA.**

LONDON, ENGLAND • • TORONTO, CANADA



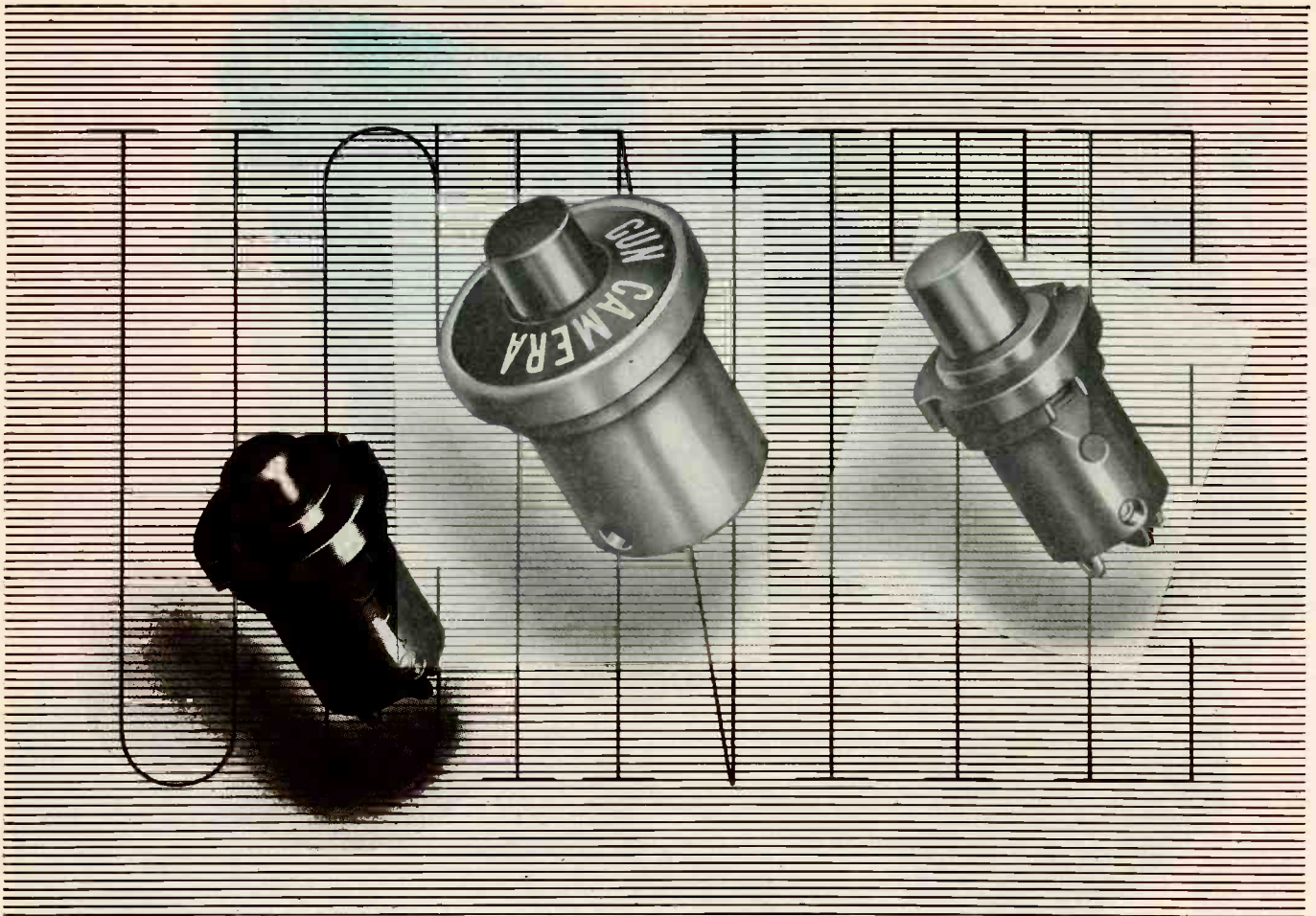

## *These little switches have big jobs*

The Ucinite push-button switch has had a lot of important jobs to do. All of them, so far, have been war jobs, of course . . . like firing machine guns and operating gun cameras and intercom microphones.

We are sure that this unique little gadget has a great postwar future. It is different from any other electric switch in design, especially useful in close quarters and will work anywhere in extreme variations of temperature and pressure.

Here is a war-developed Ucinite specialty that is worth watching from now on.

**The UCINITE CO.**

*Newtonville 60, Mass.*

Division of United-Carr Fastener Corp.

**Specialists in RADIO & ELECTRONICS  
LAMINATED BAKELITE ASSEMBLIES  
CERAMIC SOCKETS • BANANA PINS &  
JACKS • PLUGS • CONNECTORS • ETC.**

How would you make this part?

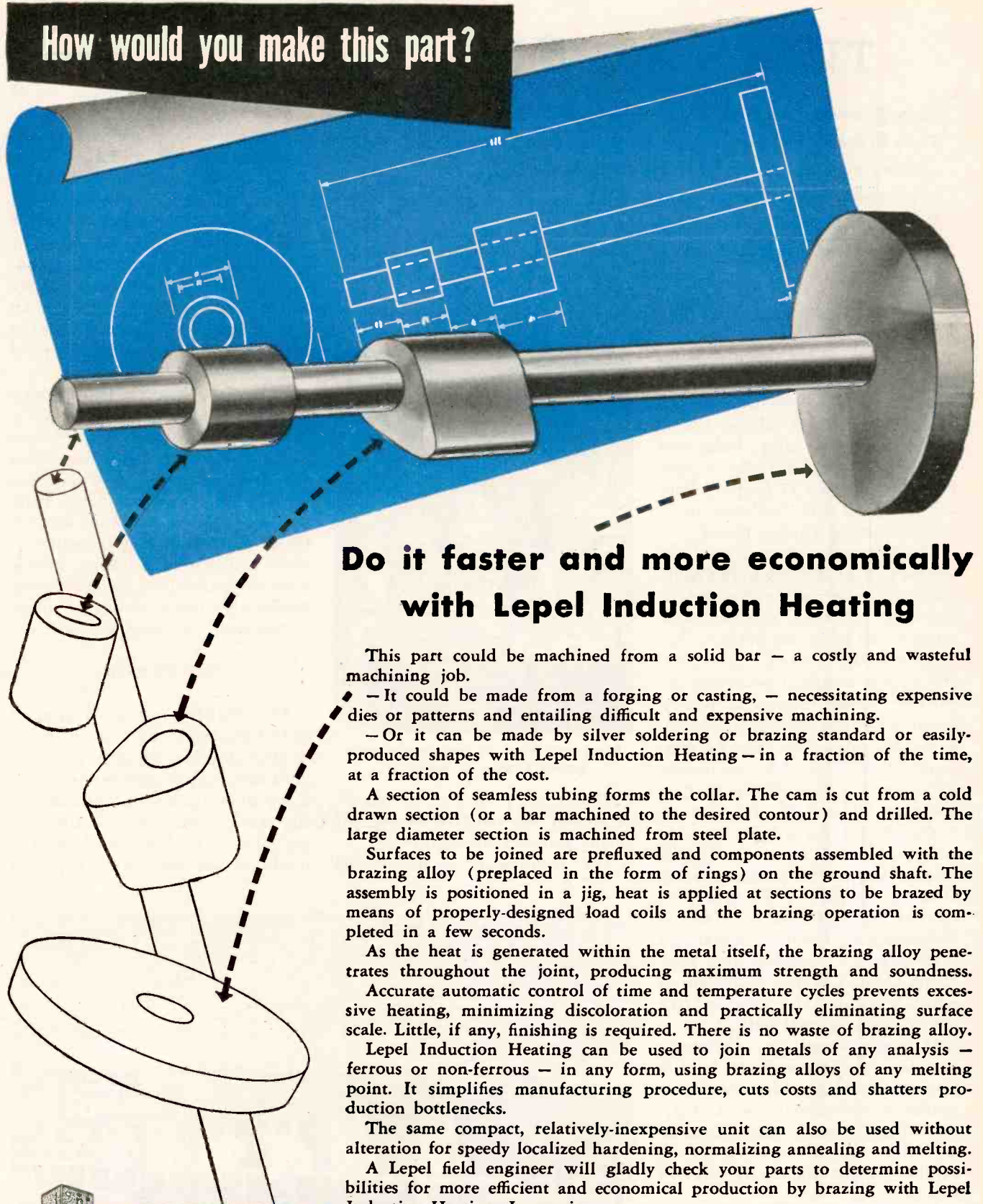

## Do it faster and more economically with Lepel Induction Heating

This part could be machined from a solid bar — a costly and wasteful machining job.

— It could be made from a forging or casting, — necessitating expensive dies or patterns and entailing difficult and expensive machining.

— Or it can be made by silver soldering or brazing standard or easily-produced shapes with Lepel Induction Heating — in a fraction of the time, at a fraction of the cost.

A section of seamless tubing forms the collar. The cam is cut from a cold drawn section (or a bar machined to the desired contour) and drilled. The large diameter section is machined from steel plate.

Surfaces to be joined are prefluxed and components assembled with the brazing alloy (preplaced in the form of rings) on the ground shaft. The assembly is positioned in a jig, heat is applied at sections to be brazed by means of properly-designed load coils and the brazing operation is completed in a few seconds.

As the heat is generated within the metal itself, the brazing alloy penetrates throughout the joint, producing maximum strength and soundness.

Accurate automatic control of time and temperature cycles prevents excessive heating, minimizing discoloration and practically eliminating surface scale. Little, if any, finishing is required. There is no waste of brazing alloy.

Lepel Induction Heating can be used to join metals of any analysis — ferrous or non-ferrous — in any form, using brazing alloys of any melting point. It simplifies manufacturing procedure, cuts costs and shatters production bottlenecks.

The same compact, relatively-inexpensive unit can also be used without alteration for speedy localized hardening, normalizing annealing and melting.

A Lepel field engineer will gladly check your parts to determine possibilities for more efficient and economical production by brazing with Lepel Induction Heating. Just write

**LEPEL HIGH FREQUENCY LABORATORIES, INC.**

PIONEERS IN INDUCTION HEATING

General Offices: 39 West 60th Street, New York 23, N. Y.

**DO IT FASTER, BETTER, MORE ECONOMICALLY BY LEPEL INDUCTION HEATING**

# TUBES AT WORK

Sixty Kilowatts On Wheels Serves Signal Corps.....	208
Time Division Multiplex, Eight Channels—One Transmitter...	212
Compressed Recordings for Carrier Pigeons.....	220
Improved Bass for Small Radios.....	224
Tubes Calibrate Heavy Artillery.....	240
Postwar Prospects for Modulated Pulse Transmission.....	244

## Sixty Kilowatts On Wheels Serves Signal Corps

A SIXTY-KILOWATT mobile radio station, the largest ever constructed, is now operating in Europe for the U. S. Signal Corps. Called SigCircus and designated officially as mobile radio station P-563, it occupies 17 large trailers and contains the facilities of a fixed station of similar power.

SigCircus can transmit and receive a total of 200,000 words daily. Besides the normal radio-teletype channels, for simultaneous transmission and reception between Europe and the United States, the station has complete broadcast facilities. These include a modern broadcast studio and control booth, a portable American Forces Network studio, complete equipment for two-way facsimile operation, and wire, film and disc recording.

The station was ordered by Brigadier General Carroll C. Bickelhaupt, Director of Communication Division of the U. S. Army, on October 26, 1944 from Le Materiel Telephonique, French associate of International Telephone and Telegraph Corp., and was delivered on schedule within three months after the original contract date.

It was designed for broadcast service to the United States, and is also capable of providing local programs for the entertainment of Allied troops within a radius of 25 to 30 miles. All the services can be carried on simultaneously without interference.

### Equipment

A special v-h-f inter-unit communications system is used between the radio transmitting and receiving groups, which are placed some distance apart to prevent mutual interference. This system includes

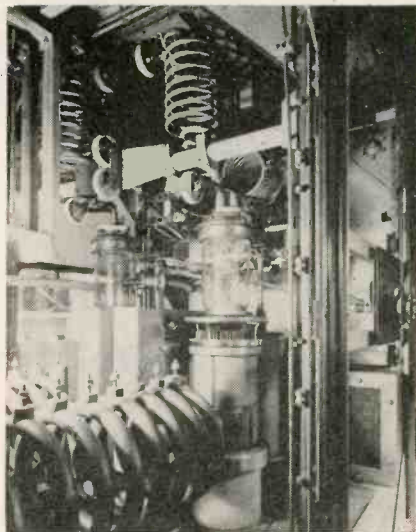

Air-cooled tubes of the intermediate power amplifier of SigCircus

voice-frequency carrier equipment to provide the required number of keying controls and channels.

The equipment is distributed

among the 17 trailers which are nominally divided into three general groups: transmitter, signal center, and power and pictorial.

In the first, or transmitter group, three trailers each contain a 50-kw Diesel power generator and a 275-gallon fuel tank. Switching from Diesel power to commercial power may be made when the latter is available. The fourth trailer contains a low-tension power supply and voltage regulator, with a 12-kv filter capacitor. Trailer 5 holds a high-voltage direct-current rectifier (12 kilovolts).

A Western Electric two-kilowatt driver unit is contained in another trailer together with v-h-f transmitters, receivers and associated carrier equipment. This trailer also contains the transmitter operating position. The driver stage feeds a 60-kw power amplifier in trailer 7, while trailer 8 has an Army Forces network transmitter, an air blower for its high power air-cooled tubes, a workshop and storage space.

### Other Facilities

Five trailers numbered from 9 to 13 form the Signal Center group. Trailer 9 holds supplies and two v-h-f transmitter and receiver systems, while trailer 10 contains special carrier equipment. Trailers 11 and 12 have six high-speed teletype machines and associated facilities

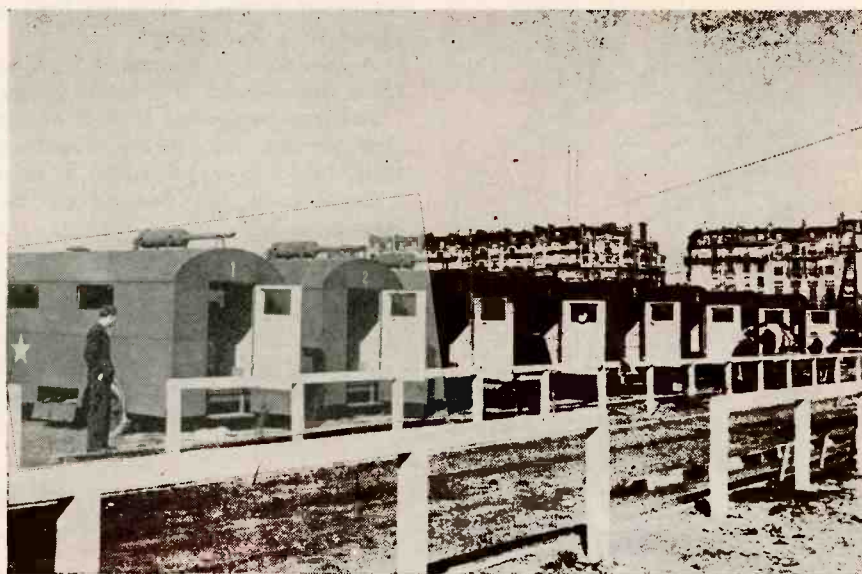

Eight of the seventeen trailers that house SigCircus, the 60-kw mobile station of the U. S. Signal Corps now operating in France. Operated by Army personnel, it was designed and built by Le Materiel Telephonique, French associate of International Tel. and Tel. Corp.



*An Original* **GUARDIAN** *Development*

designed for and in conjunction with  
the Collins Radio Company



*The New Vacuum Switch*

# KEYING RELAY

for High Frequency—High Voltage—  
High Altitude Applications

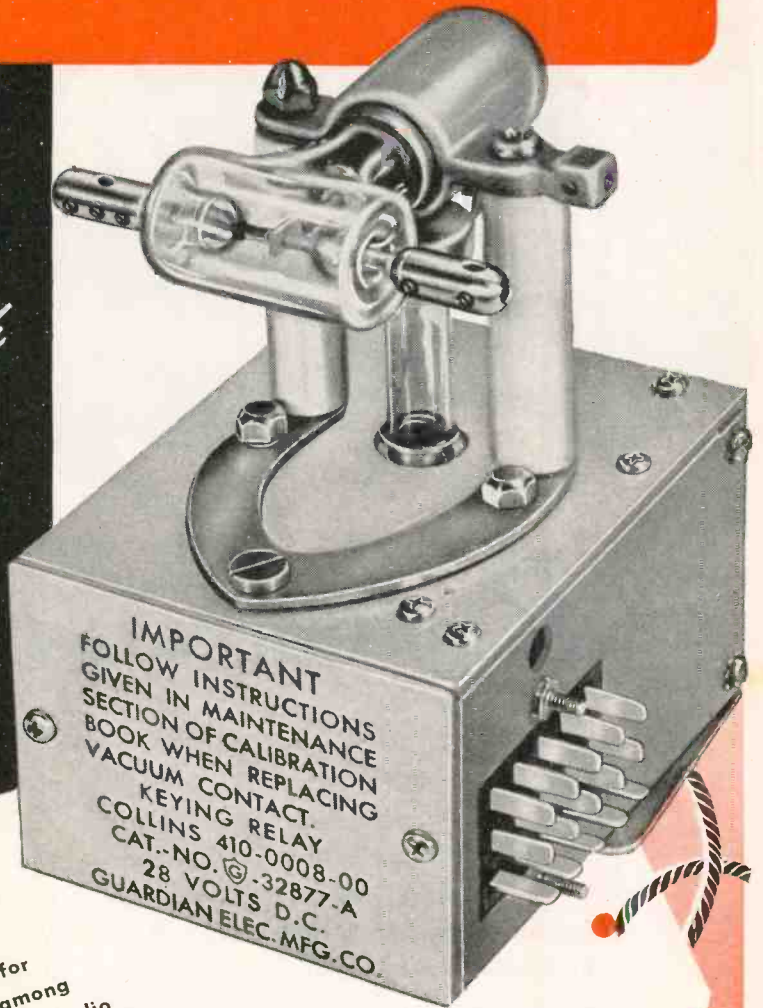

The confidential development of this vacuum switch keying relay involved design ingenuity and ability to produce immediate results. It called for cooperation and a meeting of minds among Guardian engineers and those of Collins Radio Co., the U. S. Navy, Sperti, and General Electric. Then quantity production and the responsibility of being the sole source of supply for many months followed successful development of the relay. The same confidential treatment, the same engineering ability on electrical control, the same production capacity is yours for the asking. Write.

**GUARDIAN**  **ELECTRIC**  
1625-H W. WALNUT STREET CHICAGO 12, ILLINOIS  
A COMPLETE LINE OF RELAYS SERVING AMERICAN INDUSTRY

A request on your business  
letterhead will bring you  
Guardian's new catalog.





## *Right across the "Board"*



We've been "burning the midnight oil" . . . not only to deliver to Uncle Sam all the Eastern amplification equipment needed for Army Air Forces bombers and U. S. Navy planes and PT boats, but also to translate our extensive wartime experience into sound amplification equipment for peacetime use.

Our post-war production is *right* on the drawing board! We are ready to manufacture just as

soon as Uncle Sam gives the "go-ahead."

To aid the war effort against Japan, our engineers are standing by to consult on any problem of sound amplification. Until the day of final Victory, our resources will be devoted to the design and production of vital war equipment.

Let us send you a series of useful articles prepared by our engineering staff on the newest developments in amplification related to sound systems. Ask for Series 7-F.

*Buy War Bonds*



**EASTERN AMPLIFIER**  
CORPORATION

U. S. Reg'n. Applied For

794 EAST 140th STREET • NEW YORK 54, N. Y.

WHEN YOU REQUIRE OR SPECIFY  
*Insulating Varnishes*  
 think of the CASHEW NUT...



... for from the shell of this delicious nut, Irvington produces HARVEL INSULATING VARNISHES that are tough as the combined strength of Elephant Hide and Walrus Back.

Once applied, by baking or air-drying, HARVEL sticks ... it cures by polymerization to a solid, monolithic, fused state; protecting electrical equipment against acids, dilute alkalis, moisture, lubricating and transformer oils, high temperatures, etc.

HARVEL'S RESISTANCE TO HIGH TEMPERATURE IS OUTSTANDING ... it retains its insulation resistance at temperatures up to 300° F.

HARVEL will not soften or "throw-out" at high peripheral speeds, has excellent dip-tank stability, exceptional penetrating power, the highest safety factor under excessive heat, heavy overloads and in atmospheres where acids, alkalis and abrasive materials are present.

**HARVEL WILL NOT SUPPORT FUNGUS GROWTH.**

Write for your copy of the "HARVEL INSULATION DATA BOOK" and the MITCHELL-RAND "GUIDE BOOK" OF ELECTRICAL INSULATIONS.

## H A R V E L

- cures to a non-thermoplastic, infusible state.
- will not soften or "throw-out"
- has excellent dip-tank stability.
- insures constancy of electric properties
- has no objectional solvents that attack enameled wire
- bonds conductors into a compact unit-acting mass
- has exceptional penetrating power
- has excellent insulation value at high temperatures
- produces firm, tough mechanically strong coatings
- does not give off corrosive fumes
- resists acids, alkalis and moisture
- imparts high thermal conductivity to finished coils
- is recommended for Fiberglas and Asbestos windings

and WILL NOT SUPPORT FUNGUS GROWTH

**MITCHELL-RAND**  
 for 56 YEARS  
 THE ELECTRICAL  
 INSULATION  
 HEADQUARTERS

**MITCHELL-RAND INSULATION COMPANY, INC.**

51 MURRAY STREET

Cortlandt 7-9264

NEW YORK 7, N. Y.

EST. 1889

Transformer Compounds  
 Friction Tape and Splice  
 Cable Filling and Pothead Compounds  
 Fiberglas Varnished Tape and Cloth  
 Insulating Papers and Twines

### A PARTIAL LIST OF M-R PRODUCTS

Fiberglas Saturated Sleeving and Varnished Tubing  
 Asbestos Sleeving and Tape  
 Varnished Cambric Cloth and Tape  
 Mica Plate, Tape, Paper, Cloth and Tubing

Fiberglas Braided Sleeving  
 Cotton Tapes, Webbing and Sleeveings  
 Impregnated Varnish Tubing  
 Insulating Varnishes of all types  
 Extruded Plastic Tubing

# BETTER PERMANENT MAGNETS

for:

**RADIO, SOUND and  
COMMUNICATIONS  
EQUIPMENT**

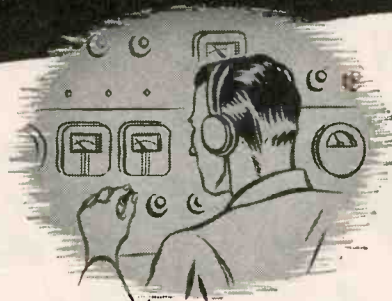

**AUTOMOTIVE  
and AVIATION  
EQUIPMENT**

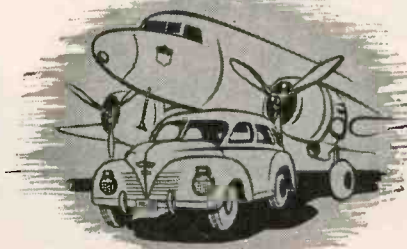

**INSTRUMENTS**

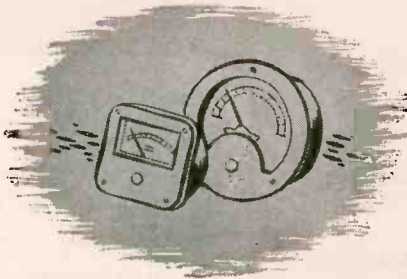

However advanced your own product-development work may be . . . however new or revolutionary the permanent magnets you require . . . Arnold engineers can be of considerable assistance to you in supplying the proper permanent magnets *in volume*. They're precision-built entirely in our own plant, under the closest metallurgical, mechanical and magnetic control to assure peak efficiency at the lowest cost.

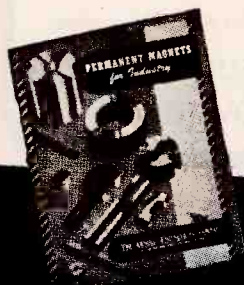

**NEW!** Get your copy of this valuable, up-to-the-minute manual on the design, production and application of modern Alnico permanent magnets. Write us, on your company letterhead, today.

Specialists in the manufacture of  
**ALNICO PERMANENT MAGNETS**

## THE ARNOLD ENGINEERING COMPANY

147 EAST ONTARIO STREET, CHICAGO 11, ILLINOIS

for handling traffic. Trailer 13 contains the facsimile transceiver units, the broadcast studio, and a control booth in which space has been set aside for the wire, disc and film recorders. This trailer is also the home of the portable American Forces network studio.

The receiving station, consisting of one W. E. receiver, v-h-f transmitters and associated carrier equipment, is fitted into trailer 14. In the power and pictorial group, two trailers each contain a 25-kw gasoline powered unit and another trailer carries the army pictorial division hut.

### Time Division Multiplex System Uses Eight Channels With One Transmitter

A COMMUNICATIONS SYSTEM, by which eight channels are transmitted simultaneously by a single radiotelegraph transmitter, is operating between New York and London to increase communication capacity between the United States and Great Britain, and, with extension of channels to San Francisco, to expedite the flow of traffic to and from the United Nations Conference. The equipment can handle 488 words per minute inward and outward



This switch is being set for eight-channel service and also permits selection of two or four channels. At each side of the switch is a face-plate mechanism that feeds to or from the seven-unit printing equipment

simultaneously. This corresponds to eight channels each way with an individual channel speed of 61 words per minute. Operation may be made on four or two channels instead of eight channels, when desired.

The eight channels may be util-

# *New..* High melting point synthetic wax

## ACRAWAX C

(Melting point ... 280° F.)

**10**  
Important  
Uses For  
ACRAWAX C.

Insulating Compounds • Sealants  
Impregnants • Potting Compounds  
Cable Saturants • Asphaltic Compounds  
Lacquers • Varnishes  
Synthetic Elastomers • Synthetic Resins

### PARTIAL LIST OF PROPERTIES OF ACRAWAX C

- 1 ACRAWAX C has an extremely high melting point (280° F.), and is also used to raise the melting point of other materials. It has a tendency to produce amorphous characteristics in its blends. Added resistance to cold flow is also imparted.
- 2 ACRAWAX C has excellent dielectric properties, and good power factor.
- 3 ACRAWAX C is insoluble in water, imparts marked water resistance and salt spray resistance to its blends. It is insoluble in practically all solvents in the cold.
- 4 ACRAWAX C melts to a liquid of low viscosity, thus facilitating penetration and impregnation.
- 5 ACRAWAX C contains no chlorine.
- 6 ACRAWAX C is compatible through hot melt procedure with a wide range of materials, many of which serve to modify it to give additional valuable characteristics such as greater adhesion, more flexible film, etc., as desired.
- 7 ACRAWAX C imparts anti-tack and anti-blocking characteristics to its compounds.

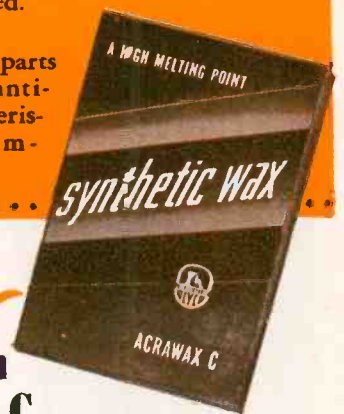

Request  
*Free*  
Bulletin on  
ACRAWAX C

from Glyco Products Co., Inc.  
26 Court St., Brooklyn 2, N. Y., Dept. G-1

Firm \_\_\_\_\_

Name \_\_\_\_\_

Address \_\_\_\_\_

**GLYCO** PRODUCTS  
CO., INC. ▶

26 COURT STREET, BROOKLYN 2, N. Y.

# KEN-RAD

*Little Giant* MINIATURE TUBES



*Better than ever*

● Wherever compact power is essential, Ken-Rad Miniature Tubes are serving staunchly . . . Now this famous make of tubes, improved still further by important new research and manufacturing facilities, will meet *better than ever* the exacting specifications being laid down by designers, builders, and users of electronic equipment.

Write for your copy of  
"Essential Characteristics"  
the most complete digest of  
tube information available.

**KEN-RAD**  
OWENSBORO, KENTUCKY

178-X-8850



## maybe the mailman can solve YOUR plastics problem

That gap between the ideas created by plastics advertising and all the specific facts a designer, molder, or fabricator may need about a plastic can often be bridged quickly by mail.

For this purpose, Monsanto has set up a fast moving Bulletin Information Service for today's fast moving plastics world... fact-packed "communiques" issued as soon as new developments are authenticated in both laboratory and field without waiting for fancy printing or arbitrary publication dates.

To "subscribe" to this free service you merely send us your name on the coupon below, indicating how you ordinarily use plastics. Meanwhile if you can use any of the current Monsanto bulletins or catalogs from the list at the right, check these at the same time. MONSANTO CHEMICAL COMPANY, Plastics Division, Springfield 2, Massachusetts.

A	The Family of Monsanto Plastics—A guide for product designers	X500-4	Thalid for impression molding. Application information
B	Resinox—A Monsanto plastic	X500-5	Thalid—Glass cloth laminates. Physical properties
C	Lustron—A Monsanto plastic	X500-6	Thalid for impression molding. Data sheet
D	Monsanto Plastics—A data book for molders and fabricators	X800-1	Resimene 803-A. Melamine molding material
E	How Vuepak Helped 20 Manufacturers to Package for Greater Sales	X800-2	Resimene 801-K—Specifications. Molding laminating resin
F	Monsanto Plastics in Packaging	X800-5	Resimene 803-A—General
G	Monsanto Plastics in Toys	X800-6	Resimene molding compounds and resins
X100-2	Monsanto casting sealant	1000-1	Monsanto vinyl butyral
X200-1	Molding of Cerex	1000-3	Application of vinyl butyral
X200-2	Cerex data sheet	1000-4	Polyvinyl butyral dispersion
X200-3	Cerex—Applications	1100-1	Handling of Fibestos sheet
X300-1	Styramic HT (polydichlorostyrene)	1200-1	Lustron 2020 Improved Polystyrene
X400-1	Divinylbenzene	1300-1	Resinox 410 general purpose phenolic adhesive
X500-1	Thalid resins for impression molding. Fabrication information		



MONSANTO CHEMICAL COMPANY, Plastics Division  
Springfield 2, Massachusetts

Please send the following bulletins:

- |                            |                                 |                                 |                                 |                                 |                                 |
|----------------------------|---------------------------------|---------------------------------|---------------------------------|---------------------------------|---------------------------------|
| <input type="checkbox"/> A | <input type="checkbox"/> F      | <input type="checkbox"/> X200-3 | <input type="checkbox"/> X500-5 | <input type="checkbox"/> X800-5 | <input type="checkbox"/> 1000-4 |
| <input type="checkbox"/> B | <input type="checkbox"/> G      | <input type="checkbox"/> X300-1 | <input type="checkbox"/> X500-6 | <input type="checkbox"/> X800-6 | <input type="checkbox"/> 1100-1 |
| <input type="checkbox"/> C | <input type="checkbox"/> X100-2 | <input type="checkbox"/> X400-1 | <input type="checkbox"/> X800-1 | <input type="checkbox"/> 1000-1 | <input type="checkbox"/> 1200-1 |
| <input type="checkbox"/> D | <input type="checkbox"/> X200-1 | <input type="checkbox"/> X500-1 | <input type="checkbox"/> X800-2 | <input type="checkbox"/> 1000-3 | <input type="checkbox"/> 1300-1 |
| <input type="checkbox"/> E | <input type="checkbox"/> X200-2 | <input type="checkbox"/> X500-4 |                                 |                                 |                                 |

Name \_\_\_\_\_

Company \_\_\_\_\_

Address \_\_\_\_\_

City \_\_\_\_\_

State \_\_\_\_\_

# FLAT Contacts

reduce noise, prolong service life



**VARIATEN #1218**  
"T" Circuit— $1\frac{1}{2}$  db per step; 30 to 600  
ohms impedance. Price, F.O.B...\$17.50

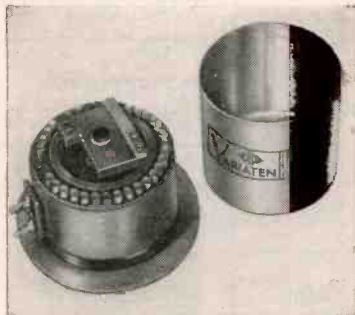

**VARIATEN #1156**  
Ladder Circuit— $1\frac{1}{2}$  db per step; 30 to 600  
ohms impedance. Price, F.O.B...\$12.50



**VARIATEN #1658**  
Ladder Circuit— $2\frac{1}{2}$  db per step; 30 to 600  
ohms impedance. Price, F.O.B...\$5.75

**VARIATEN** contacts and brush surfaces make contact over their entire area because the contacts are ground flat and the brushes stone-lapped, *not* buffed. Buffing produces rounded surfaces and therefore a "point" contact highly susceptible to noise. Variaten brushes move from one contact to the next without rocking motion. The resulting perpendicular spring pressure at all positions allows us to take advantage of the natural resiliency of metals to provide a completely flat contact over the entire brush surface at all times and so reduce noise and lengthen service life.

#### No carbon resistors are used in any Variaten Mixer...

All are of stable, wire-wound construction. Most are step type. Where quiet operation is the major consideration, we recommend ladder type mixers because the circuit requires only one contact brush operation on the input side of the circuit and any possible brush noise is therefore attenuated along with the signal.

By all means compare circuits, construction and features of these mixers. From the hundreds of Variaten attenuators you may select the attenuators best adapted to your specific needs. Write for the Variaten Catalog today.

ized for two-way communication with one distant station or four channels, with a total capacity of 244 words per minute, can be operated in both directions simultaneously between two different stations. Automatic retransmission of one or more of the channels to a third station, may be made.

Developed by RCA, the multiplex system uses a printing mechanism that makes the circuit practically error-proof, despite its high speed. If a letter be mutilated or garbled in transmission, a warning bell

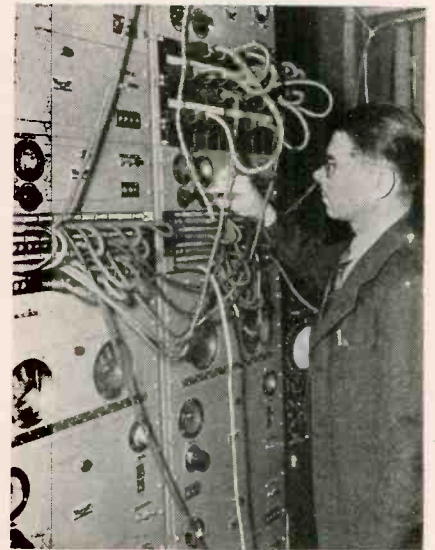

Receiving and transmission panels used in the multiplex system developed by RCA. On each can be seen the front face-plate assemblies of the multiplex distributors that pass incoming or outgoing signal elements from and to the seven-unit printing equipment in the proper sequence and at the proper time intervals

rings at the receiving printer. Instead of the mutilated character, a Maltese cross appears to mark the exact spot of the error and facilitate correction.

#### Seven-unit Printer

Development of the new multiplex equipment began less than two years ago, but for some time before that date RCAC research engineers succeeded in the use of a seven-unit printer which is employed in the new system. Such a printer has been employed continuously since 1939 for handling commercial traffic over the New York-San Francisco radio circuit.

The printer is completely auto-



**CINEMA ENGINEERING CO.**  
Established 1935 • Burbank • California



*Presenting*

## THE BENDIX TG-15 500 WATT TRANSMITTER



for operation  
on

**L.F. LOW FREQUENCY**  
200-540 Kilocycles

**H.F. HIGH FREQUENCY**  
2-13 Megacycles

and

**V.H.F. VERY HIGH FREQUENCY**  
108-132 Megacycles

A four-channel transmitter, capable of simultaneous operation on any two channels, the Bendix TG-15 transmitter is rated at a full 500 watts for continuous Commercial Service at any frequency in the L.F. and H.F. ranges and 300 watts C.C.S. in the V.H.F. range.

Ease of maintenance, flexibility and traditional Bendix reliability make this transmitter particularly suited for aeronautical services in this country and in foreign operations.

A bulletin describing the TG-15 transmitter is available. Write for your copy.

# **Bendix** Radio **DIVISION**

BALTIMORE 4  MARYLAND

PRODUCT OF BENDIX AVIATION CORPORATION

**STANDARD FOR THE AVIATION INDUSTRY**

# Investigate

## POLLAK'S CO-RELATED FACILITIES

### FOR MANUFACTURE OF PRODUCTS AND ASSEMBLIES FOR POSTWAR PRODUCTION

Looking ahead to the time when materials and manpower can again be devoted to industrial production, we list below some of the specialized features of Pollak facilities.

Pollak has ample equipment in these specialized departments for coordinated operations

to turn out complete products and assemblies.

Pollak also has engineering and research facilities for designing and building complete products preparatory for production, *when our plants are released from war work.*

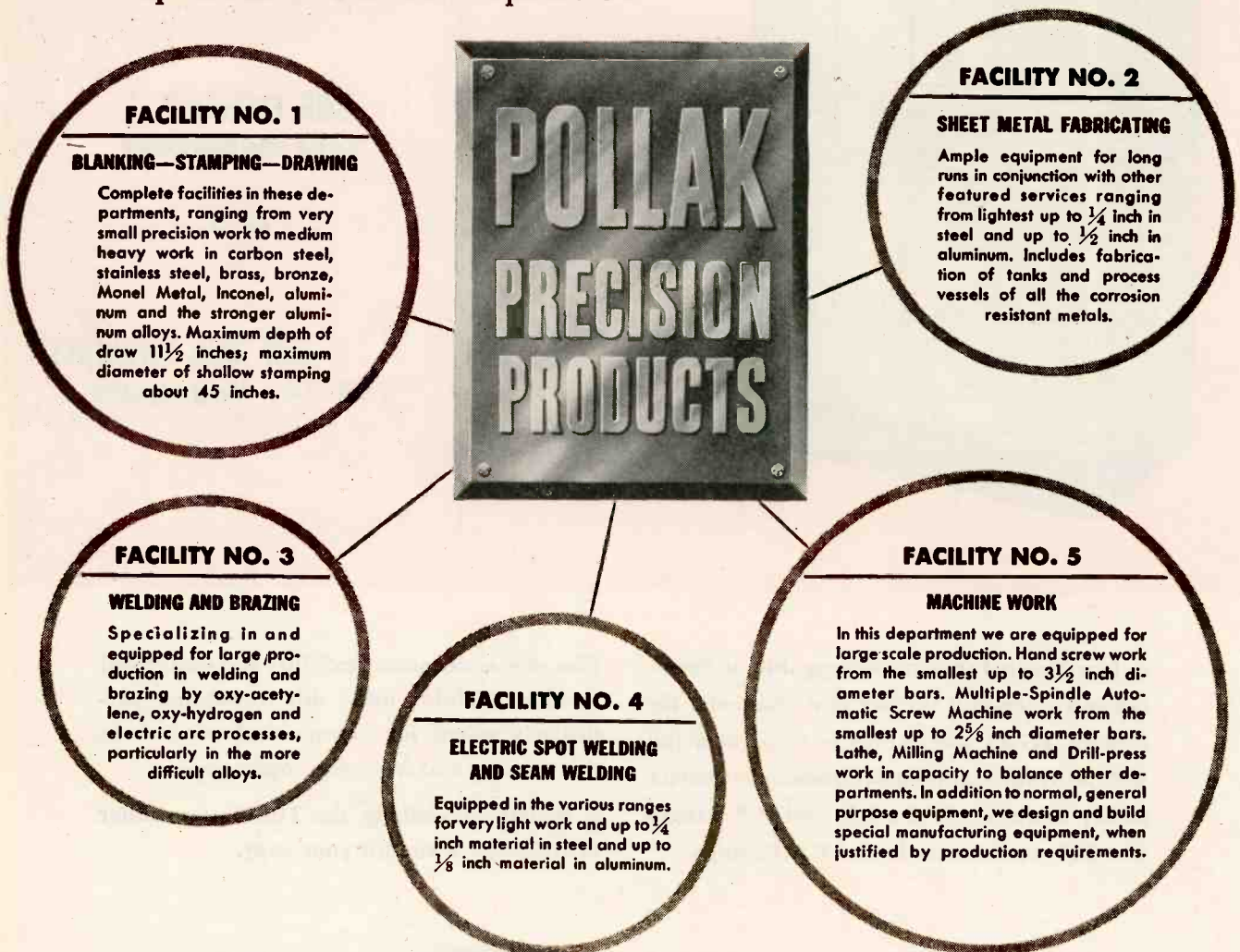

These Pollak facilities are operated in conjunction with other manufacturing departments such as Spinning, Electrical Work, Heat Treating, Assembly and Plating. These individual Pollak facilities are operated as a unit and ordinarily they are available only for work of a nature which will keep this operation in balance. However, this limitation is not always applicable.

## POLLAK MANUFACTURING COMPANY

Arlington, New Jersey

**VARNISHED  
FIBERGLAS-  
AND-FIBER**

**DUPLEXED  
VARNISHED  
FIBERGLAS**

**SPECIAL THIN  
SLOT  
INSULATIONS**

# 3 IMPROVED SLOT INSULATIONS BY IRVINGTON

Irvington again sets the pace with three improved insulations:

*Varnished Fiberglas-and-Fiber*, that combines the heat and moisture resistance and high mechanical strength of flexible Fiberglas with the high insulating qualities of Irvington formulated varnish.

*Duplexed Varnished Fiberglas*, that furnishes added protection against high temperatures and dampness with two layers of varnished Fiberglas that are flexibly bonded together, providing increased dielectric and mechanical strength and improved cushioning effect.

*Special Thin Slot Insulations*, consisting of varnished Fiberglas, rayon, nylon or cambric, duplexed to rag paper, in extremely thin combinations which provide high dielectric insulations for narrow and shallow slots wherever space is limited.

With these three additions to its broad line, Irvington further increases its leadership in the production of slot insulations to meet all operating conditions and requirements. Complete cooperation in fulfilling your needs is freely offered. Write Department 106.



Other Irvington products include... insulating varnish, plastic tubing and tape, varnished tubing, varnished fabrics, varnished Fiberglas, wire markers, Cardolite Compounds.

## **IRVINGTON**

**VARNISH & INSULATOR CO.**  
Irvington 11, New Jersey, U. S. A.

**LOOK TO IRVINGTON FOR CONTINUED LEADERSHIP IN INSULATION**

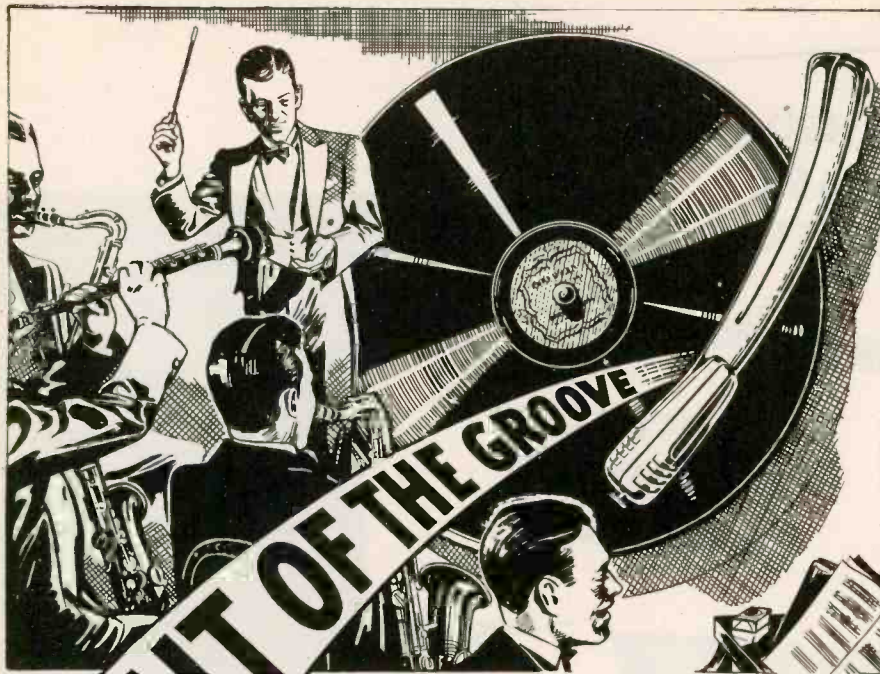

# OUT OF THE GROOVE

**S**OUND is captured and imprisoned upon a phonograph record. Its release for entertaining, educational and commercial use has for years been made possible by The Astatic Corporation through Astatic Phonograph Pickups. Long favorites with most leading manufacturers and jobbers of phonographs and phonograph equipment, Astatic Pickups have supplied the highest degree of quality and fidelity to record reproduction. For the days ahead, Astatic promises even greater true-to-life tonal realism, improvements in pickup design, construction and operating efficiency that will contribute immeasurably to the clarity and beauty of reproduction from the new, fine-grain, noise-free, Vinylite recordings of tomorrow. Conversion to peacetime production, when such permission is given, will be prompt and Astatic's greatly increased manufacturing facilities will be ready to serve its great host of manufacturing and jobber customers.

**"You'll HEAR MORE  
from Astatic"**

ASTATIC Crystal Devices  
manufactured under Brush  
Development Co. patents.

**THE**  
*Astatic*  
**ASTATIC CORPORATION**  
CONNEAUT, OHIO

IN CANADA, CANADIAN ASTATIC LTD., TORONTO, ONTARIO

matic and, in conjunction with the multiplex mechanism, the system functions with a minimum loss of circuit time. In the seven-unit system, each incoming letter is formed of three marking (signal) impulses, plus four spacing (no signal) impulses. Automatic counting is done in the receiving printer to check the arriving impulses, and if the marking impulses vary from three, the warning bell sounds and the Maltese cross appears to report an error.

The multiplex equipment is also able to handle other telegraphic codes. A different code can be used on each of the four pairs of channels if desired.

### Routing Speed

Traffic from San Francisco to London passes through the synchronized equipment in the New York office of RCAC, at 66 Broad Street, where the channels are separated automatically. From there they go to the transmitting station at New Brunswick, then across the Atlantic. Routing from the British capital also includes passage through New York. A mechanical delay of only one-sixth of a second occurs in the transmission in either direction.

The system makes possible simultaneous transmission over four channels each way between San Francisco and London through New York, but the routing can be shifted, for instance, to send messages from either city to the Argentine over the three-channel New York-Buenos Aires circuit.

Each channel utilizes two bells for signalling. One rings when an incorrect group of signal elements reaches the receiving printer, and the other, of different pitch, is operated by means of a switch similar to a telephone dial. With it, the receiving operator can pass a number of stock phrases for service instruction to the other end of the circuit, thereby saving channel operating time.

• • •

### Compressed Recordings for Carrier Pigeons

ONE HOUR OF SPEECH, reproduced on a light thin film that can be carried in a capsule strapped to the

# ELECTRONIC BRAZING

## UNIT

with

## 24 Station

## INDEXING

## Work Carrier

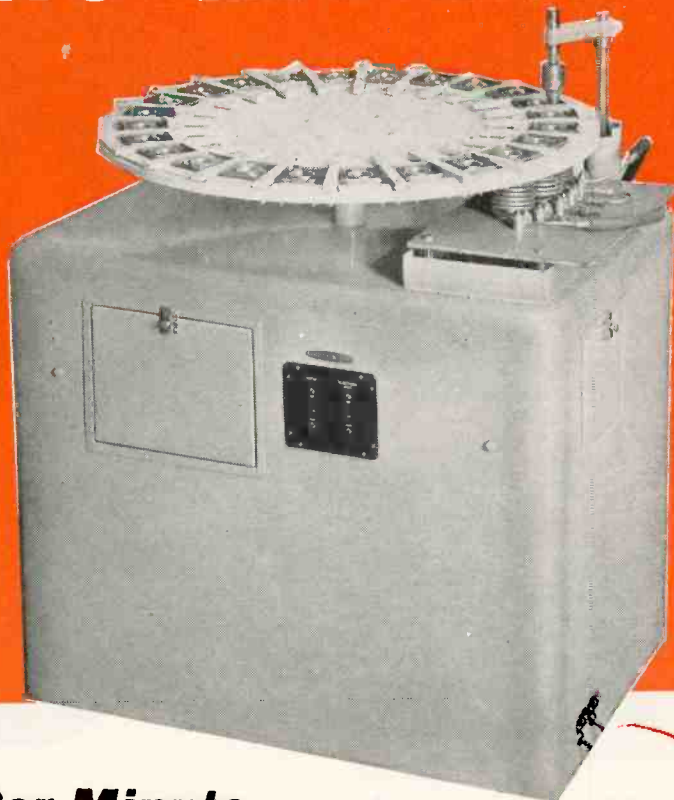

**Delivers 5 Complete Assemblies Per Minute**

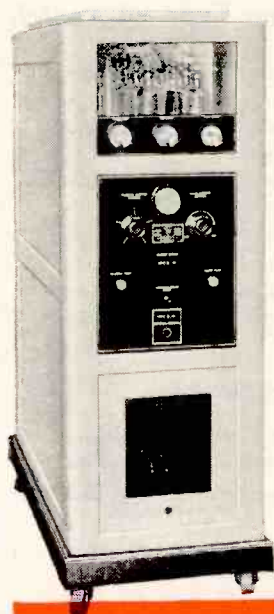

**H**ERE'S a striking example of how Scientific Electric Engineers increased brazing production output by designing a special automatic machine to operate in conjunction with Electronic heating.

A manufacturer of weather-proof control box covers was already using electronic heat to speed up production in the brazing operation involved. But greater production was urgently needed. Each assembly was being inserted and removed from a single heater coil . . . one at a time.

To increase output Scientific Electric engineers designed this compact circular, 24 station indexing work carrier which operates from the 18 KW electronic generator at the left.

The operator merely loads the stations as they come around empty. Heat is applied by three water-cooled induction coils under three of the work positions. The coils are followed by the vertically operating ejecting mechanism and a complete assembly is ejected from the carrier each 12 seconds.

The carrier, which is operated by a small motor can be applied to any of our electronic generators depending upon the heat input requirements of the work to be handled. Normal output of the unit illustrated is at 200 to 600 kc.

Workpiece output up to 20 per minute can be obtained and carriers, custom tailored to your requirements, can be delivered within 30 days. Send us your requirements today.

Scientific Electric Electronic Heaters are made in these power sizes... and a range of frequencies up to 300 Megacycles depending upon power requirements.

3 KW	18 KW
5 KW	25 KW
7½ KW	40 KW
8 KW	60 KW
10 KW	80 KW
12½ KW	100 KW
15 KW	250 KW

# Scientific Electric

Division of

"S" CORRUGATED QUENCHED GAP COMPANY

119 MONROE ST.  GARFIELD, N. J.

Manufacturers of

Vacuum Tube and Spark Gap Converters Since 1921

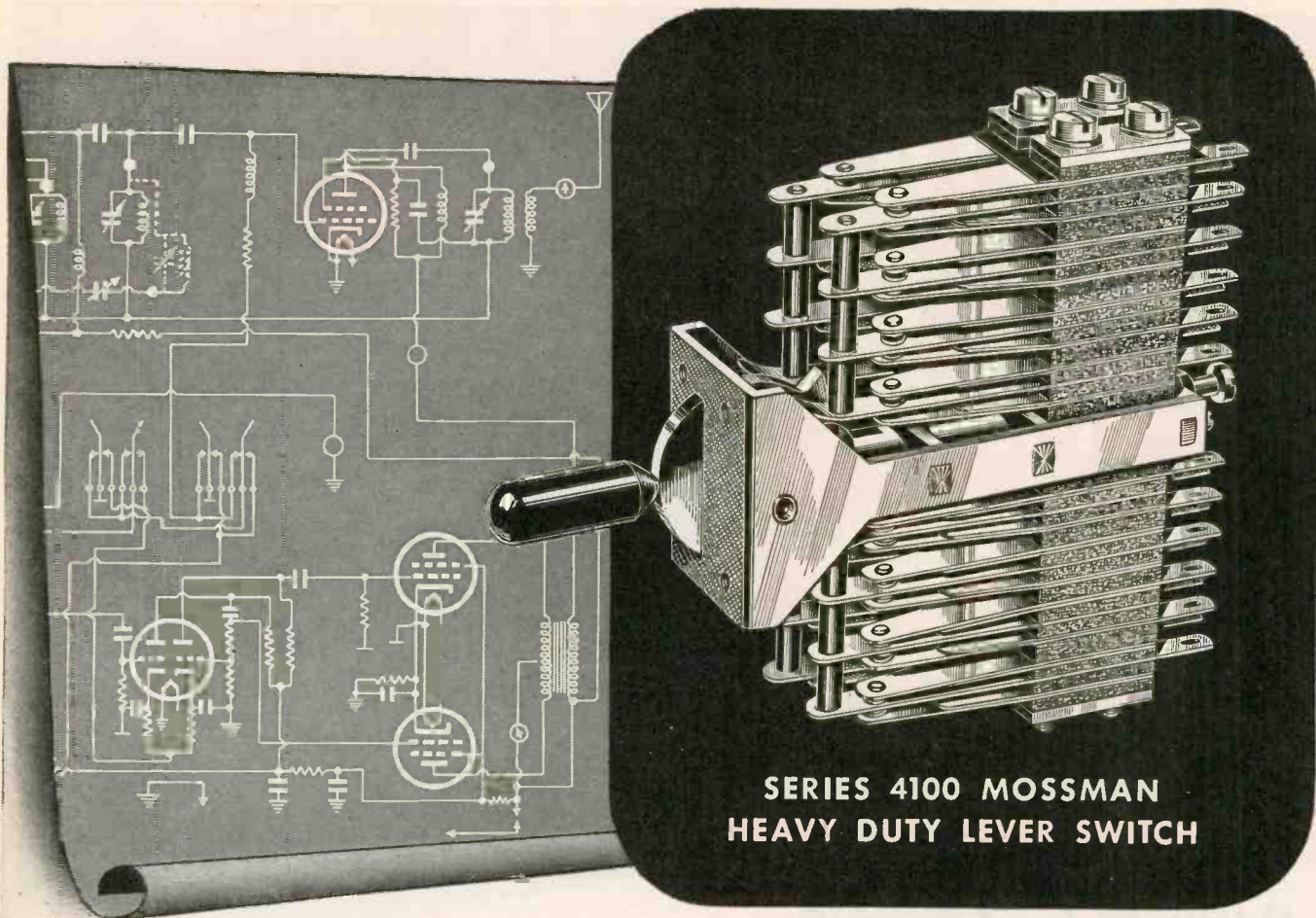

**SERIES 4100 MOSSMAN  
HEAVY DUTY LEVER SWITCH**

## **This Mossman Lever Switch** *Provides Interlocking Contact Arrangements Impractical with Any Other Type of Switch*

The Mossman Series 4100 Switch is especially adapted to radio or electronic control circuits where it is necessary to switch a control or monitoring position to a master control or amplifier station.

The number and type of interlocking circuits possible with this switch are entirely at the discretion of the designer of electrical or radio control circuits.

Interlocking contact arrangements which may be added or provided by the use of this versatile switch would be impractical with any other type of switch or plug-in system.

Important advantages of this switch for radio and electronic circuits include:

- Protection of amplifier or transmitter tubes by keeping grid or similar circuits closed until switching is accomplished.
- Preference automatically given to one station over others when such a station desires to contact the master station.
- Ability to keep certain circuits open until another is closed, or closed until another circuit is opened.
- Elimination of the possibility of cutting in more than one remote station or control. This is often desirable when several remote stations feed to a central unit.

### *Check these Features*

- ★ A three-position switch (Series 4101) with locking action in center or neutral position, locking or non-locking in other two positions.
- ★ A two-position switch (Series 4102) by use of a special latch plate which eliminates the neutral position.
- ★ Contact Ratings: Standard heavy duty— $\frac{3}{16}$ " diameter, fine silver, 10 amperes, 110 volts A.C. (non-inductive); Extra heavy duty— $\frac{3}{16}$ " diameter, silver alloy, 20 amperes, 110 volts A.C. (non-inductive).



#### **SEND FOR THE MOSSMAN CATALOG**

In it you will find complete details of the Mossman Series 4100 Switches and the many other precision electrical components which make up the Mossman line. These include many types of Mossman heavy duty, multiple circuit lever switches, turn switches, push switches, plug jacks and other special switching components.

**DONALD P. MOSSMAN, Inc., 612 North Michigan Avenue, Chicago 11, Illinois**

**MOSSMAN**  
*Electrical Components*

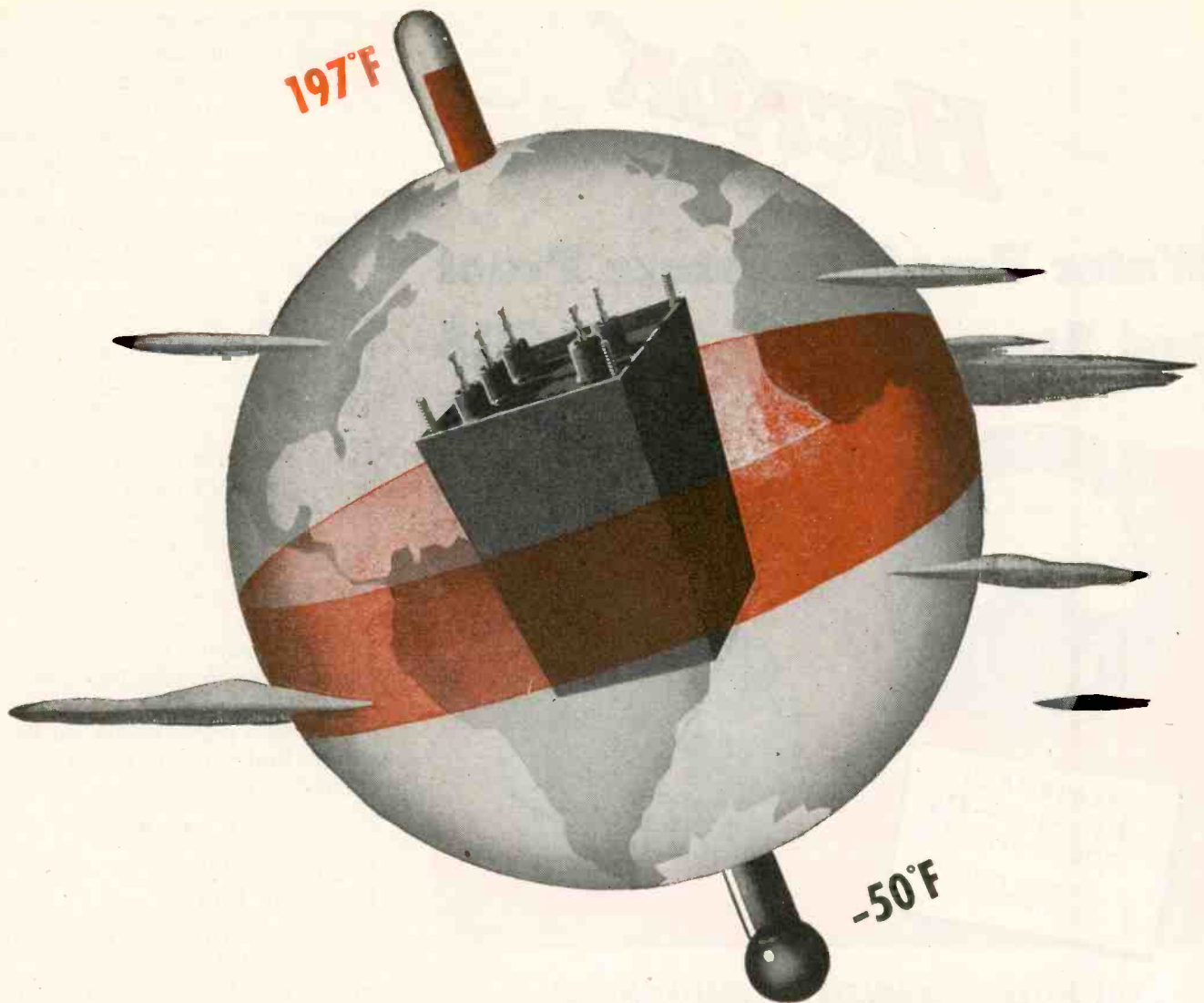

## Torture Test — **DOUBLED!**

The story of a transformer yanked back and forth from Pole to Equator

Men of the U. S. Army Signal Corps say that no matter where they run their lines, "It's either too hot or too cold." To make sure equipment can take it, the Corps runs the five-cycle humidity test.

They were giving this test to a Thermador transformer. They put it into a chamber, pressed a button to get the bleak 50° below. They pressed another button, the thermometer shot to the 197° of a blazing equatorial noon. Five times they raised and lowered the temperature. They watched, through the glass doors, water dripping onto the transformers—condensation.

After forty-eight hours they took an ice pick to get at the terminals.

They wiped them dry, connected the current, threw

on the switch. If, after this torture, the transformer could take 2,000 volts it would pass the test. They gave it not 2,000 but 4,000 volts, doubling the test—and, of course, it took it!

BUY MORE WAR BONDS!

THERMADOR ELECTRICAL MANUFACTURING CO.

5119 South Riverside Drive • Los Angeles



THERMADOR

TRANSFORMERS

DEFEAT HEAT COLD HUMIDITY



# HICKOK

## Water Proof, Moisture Proof and Steam Proof METERS

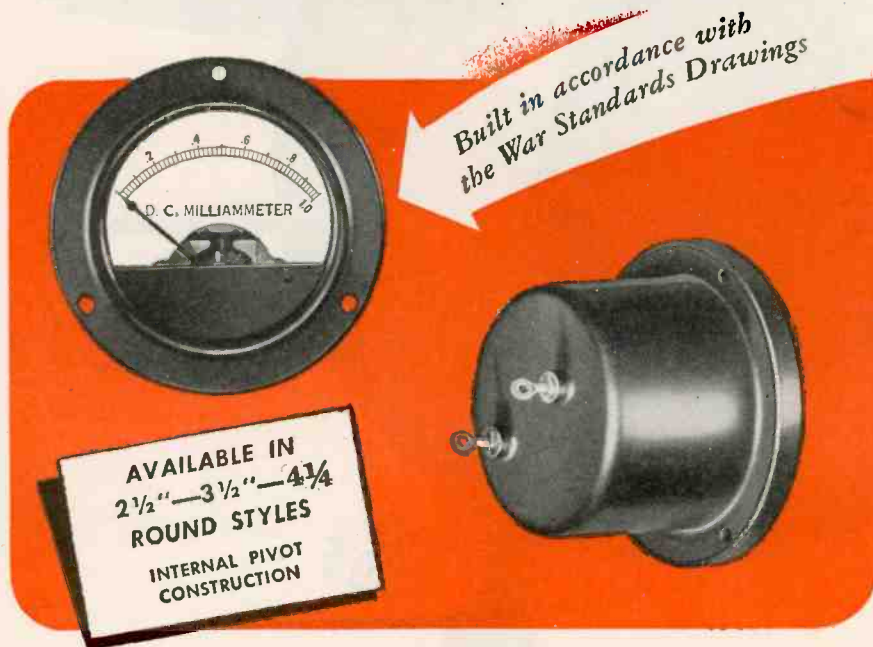

**VOLTMETERS . . . AMMETERS . . . MILLIAMMETERS . . .  
MICROAMMETERS . . . WATTMETERS . . . BOTH AC AND DC**

Now, you can get HICKOK precision and dependability in a new line of hermetically sealed meters. Available in 2½", 3½" and 4¼" round styles. Dimensions of American War Standards Assn. Drawings C39.2-1 and C39.2-2. The 4" size is built especially for use in radio service equipment where several scale arcs are required.

All instruments are hermetically sealed and both vacuum and pressure tested under water. Case fabricated of pressed steel and made corrosion resistant to meet specifications. Terminals are a special glass soldered-in type.

All meters are fully shielded, permitting use on either magnetic or non-magnetic panels. Operation is accurate and dependable even up to 85° centigrade. Internal pivot construction in D.C. types assures longer life and greater resistance to shock and vibration. Write for further information today.

**THE HICKOK ELECTRICAL INSTRUMENT CO.**  
10527 DUPONT AVENUE · CLEVELAND 8, OHIO

PRECISION CALIBRATED . . . LASTING ACCURACY

COMPRESSED RECORDINGS (continued)

back of homing pigeons, has been made possible by a recent improvement in sound recording sponsored by the Signal Corps. About twenty times as much wordage can be recorded on the film as can be typed on paper of similar surface area.

The film is made of ethyl cellulose, similar to ordinary cellophane. The belt is one foot long and 3½ inches wide, of which three full inches can be used for voice reproduction. The film belt takes thirty minutes to run its full course and can be turned inside out to take a similar recording on the other side so that one full hour of speech fills a single thin belt. Average talking has been found to run about 150 words to the minute, but some rapid talkers are able to enunciate 300 words per minute.

Approximately 18,000 words can be put on one film belt. Two belts fit into a four-inch capsule for harnessing to a pigeon's back, so that a single bird can carry 36,000 words of spoken message.

### Improved Bass for Small Radios

SMALL LOUDSPEAKERS do not radiate efficiently at low frequencies. If one attempts to compensate for this deficiency by feeding greater low-frequency power to the speaker, the speaker will be driven to such an extent that it will introduce non-harmonic distortion.

The shock to the cone on reaching its limit of travel due to large signals will be translated into vibrations at speaker resonance. Because the cone will break into multiple modes of vibration, the radiation efficiency will be further lowered. The effect is that the speaker booms, not that there is greater low-frequency radiation.

#### *Synthetic Bass Principle*

It is not economically feasible in small receivers to use speakers that have flat response to low frequencies. The sizes of speaker and baffle are limited by the receiver dimensions, therefore poor low-frequency radiation is an inherent characteristic of small receivers and phonographs. Synthesized base provides a solution.

What makes such a system pos-



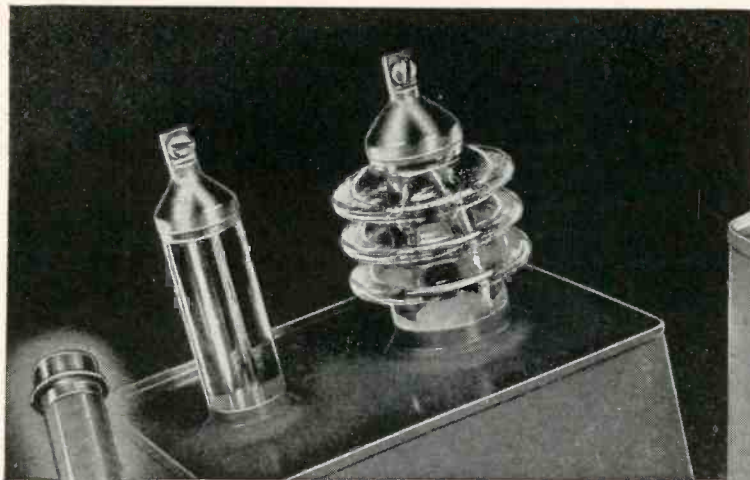

### GLASS-TO-METAL SEALS

The old problem of protecting various capacitor and resistor types against leaks and moisture is solved by a unique glass-to-metal seal pioneered and perfected by Sprague. Glass capacitor bushings are sealed direct to the metal container and do not require adjacent metal rings with "matched" coefficients of expansion. On Sprague \*KOOLOHM Resistors, the units are encased in glass tubes which are sealed directly to the metal ends. The resulting seals are leak-proof, shock-proof, humidity-proof, and fungus-proof.



## A Step Ahead!

Sprague engineering progressiveness is no better exemplified than by the three outstanding achievements depicted here. And remember, such developments are only the high spots! Equally important is the fact that similar, if less startling, engineering superiority is evidenced in every one of the hundreds of Sprague Capacitor and \*Koolohm Resistor types that are regularly produced. Even small points of departure from the conventional often make a startling improvement in results—and no type or design produced by Sprague is so humble as to fail to receive regular engineering attention in a constant effort to surpass for Tomorrow that which is "best" Today.

**SPRAGUE ELECTRIC COMPANY**  
North Adams, Mass.

**SPRAGUE**  
PIONEERS OF RADIO-  
ELECTRONIC PROGRESS



### \*VITAMIN Q

### HIGH-VOLTAGE, HIGH-TEMPERATURE PROBLEMS SOLVED

When you've got both high voltage and high temperature to contend with in a capacitor application—well, ordinarily, you'd have a problem on your hands. Once again, however, Sprague engineering supplies the answer. Although extremely compact, Sprague Capacitors impregnated with \*VITAMIN Q operate satisfactorily at thousands of volts at ambients as high as 105°C. Insulation resistance at room temperature is more than 20,000 megohms per microfarad—or at least five times better than previous types.



## \*CEROC 200

### PERMITS 200° C. CONTINUOUS OPERATION

Many types of electrical equipment can now be designed for 200° C. continuous operation, thanks to the Sprague wartime development of \*CEROC 200, a flexible ceramic (inorganic) insulation for copper, nickel, and other types of wire. Smaller equipment can be designed to do bigger jobs. \*CEROC 200 dissipates heat rapidly and has an extremely good space factor. You'll be hearing a lot about \*CEROC 200 in days to come!

\*Trademarks Reg. U. S. Pat. Off.

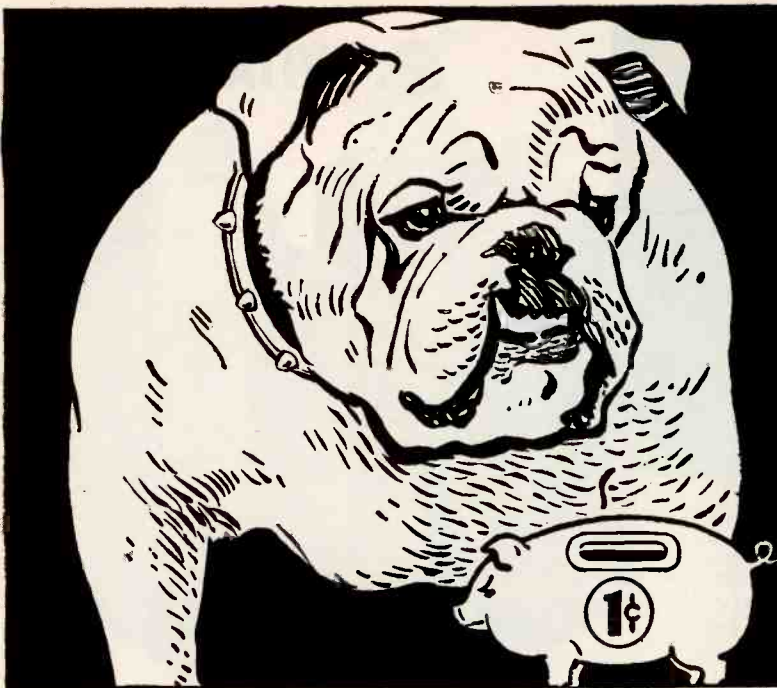

**YOU'LL HAVE**

**TO WATCH**

**YOUR PENNIES...**

## **IN THE PEACETIME COMPETITION**

With the coming of peace and a return to the American way of producing goods at a profit in highly competitive consumer markets you'll *have* to be certain that every step from initial blueprint and tool design, through the machining, stamping and assembly line, up to packaging and delivery is planned and executed with utmost efficiency and with the minimum of cost.

In the production of war munitions Oiljak has maintained an enviable record of production of intricate parts and on time deliveries, in accordance with strict Government inspection—and has actually reduced the estimated and approved cost, thus saving the Government considerable sums, by skillful planning and supervision of the work. These same skills in metal manufacturing, improving designs and reducing costs are available to manufacturers as they convert to peacetime merchandise. It may transmit your penny savings into dollar profits to confer with us on any metal manufacturing problem.



MACHINING • STAMPING • WELDING • PLATING • FINISHING • ASSEMBLING

M E T A L M A N U F A C T U R E R S

**THE OILJAK MANUFACTURING Co., INC.**

MONTCLAIR, NEW JERSEY

THE JOB COMPLETE FROM BLUEPRINT TO FINISHED PRODUCT

More than **35** Years of  
Service

to the

# RADIO INDUSTRY

Whether Amplitude Modulation . . . Frequency Modulation . . . or Television — dependability is a *must* for all broadcast equipment.

Federal broadcast equipment has earned a reputation for that dependability because *it stands up*.

For more than thirty-five achievement-studded years . . . from the Poulsen Arc to the new CBS Television Station . . . Federal has served the broadcast industry with superior equipment.

Federal's background includes such milestones of electronic progress as the 1000 Kw Bordeaux Transmitter; Micro-ray, the forerunner of modern television technique; and the first UHF multi-channel telephone and telegraph circuits, part of a world-wide communications system . . .

All this, plus the war-sharpened techniques that are the result of ability *and* experience, combine to give you craftsmanship . . . the kind of craftsmanship that builds dependability into all Federal equipment.

In AM . . . FM . . . TV . . .

. . . your prime need in broadcast equipment is dependability — *look to Federal for it.*



*Federal Telephone and Radio Corporation*



Newark 1, N. J.

★  
*Max.  
 12 Grams  
 Pressure*  
 ★

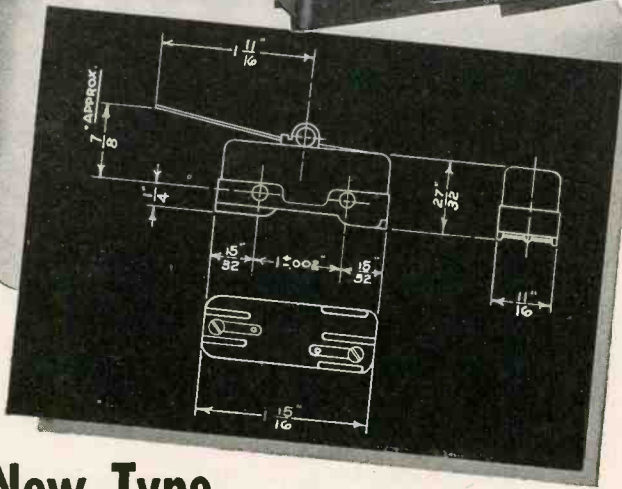
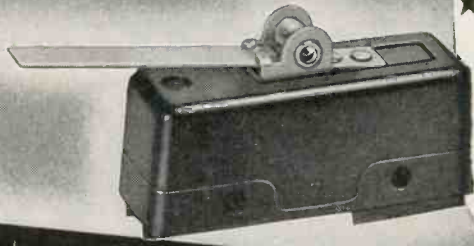

**New Type**

*Acro Snap*

**Switch**

You can now get Acro precision and long life in a snap-action switch requiring only 12 grams maximum operating pressure. Some special models have been built with operating pressures as low as 6 to 8 grams. Like all Acro switches this new hinged leaf type incorporates the famous patented beryllium rolling spring. Pretravel is approx.  $3/32''$ ; overtravel, approx.  $3/16''$ ; movement differential, approx.  $.040''$ ; rated 10 amps. at 115 volts A.C. Available for normally open, normally closed and double throw circuits. This is just one of many compact, time-tested Acro designs for better current control. Write for new catalog today.

**THE ACRO ELECTRIC COMPANY**

1316 Superior Avenue

Cleveland 14, Ohio

sible is that the ear itself is a non-linear device introducing harmonics into the sound that it receives. Because of this characteristic of the ear, the aural effect of a low note can be produced by introducing into the ear the harmonics that the ear would generate itself if it were really receiving that low note. Physiologists have long known that a combination of odd harmonics of a low frequency give the impression to the hearing organs of the presence of that frequency even though the fundamental is itself absent. This characteristic of the ear is used by organists to play, in effect, notes that are lower than the ear can actually hear.

Applied to small radio receivers and phonograph amplifiers, the technique consists of introducing non-linearity into the output stage but only at low frequencies. This non-linearity introduces odd harmonics, chiefly third, in place of the low-frequency note. The odd harmonics are efficiently radiated by the speaker and heard and interpreted by the ear as if they were the low note from which the harmonic series was originally derived.

In taking advantage of the ear's characteristic to produce the appearance of low-frequency reproduction through the loudspeaker,

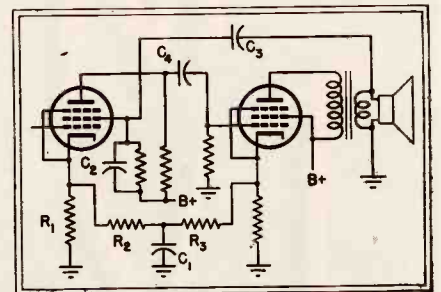
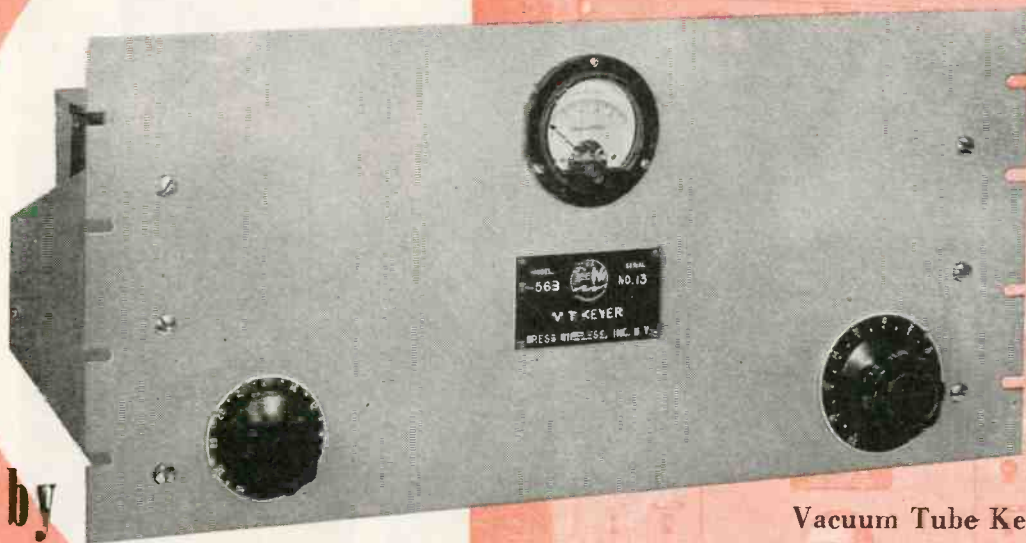

FIG. 1—Application of Synthetic Bass to the output of a typical table-model radio-phonograph, showing essential additions to the circuit

the system also augments the receiver's output characteristic to compensate for the changes in frequency response of the ear with volume level.

The ear's sensitivity for low tones at low volume is relatively less than its sensitivity for low tones at high volume. Thus in listening to low-level reproduction, to the ear the set appears to have less bass output

# VT KEYERS



by

## Press Wireless

Vacuum Tube Keyer T-156B

VT Keyer T-156B was developed in Press Wireless laboratories to provide several specific facilities for handling large volumes of urgent outbound traffic over our international radio press circuits. The job such a unit must perform in this 24-hour-a-day, high speed, mechanized service compelled us to engineer rugged and exacting design into this keyer.

This keyer receives tone signals from a remote control point and delivers d-c pulses for keying a CW transmitter.

The non-critical input level control accommodates signals from +20 vu down to -20 vu.

Unstable transmission losses between the remote control point and transmitter may be disregarded since an automatic level regulatory circuit permits input signal level fluctuations as great as  $\pm 6$  decibels without appreciably affecting the keyer output, a feature of paramount importance to all mechanized radio circuits.

Undesirable noises and cross-talk will be eliminated when signal is only 6 db above background interference.

The d-c keying output of the T-156B Keyer provides a "space" signal approximately -35 volts and a "mark" signal of zero volts. Simple adjustments—high speed keying capabilities—low maintenance factor—automatic level regulation—self contained power supply—are among the features that give the T-156B Keyer its high efficiency and dependability.

*Operates from 110/115 volts, 50/60 cycles AC.*

*Available in strict priority sequence. Send for free data sheet.*

### PRESS WIRELESS, INC.

Executive and Sales Office 1475 BROADWAY, NEW YORK 18



Awarded to our Hicksville, L. I. plant for outstanding achievement in war production.

PARIS · BUENOS AIRES · RIO DE JANEIRO · MONTEVIDEO · MANILA · BERNE · SANTIAGO DE CHILE · NEW YORK · CHICAGO · LOS ANGELES · LONDON · HAVANA

# Sheet Metal Fabrication

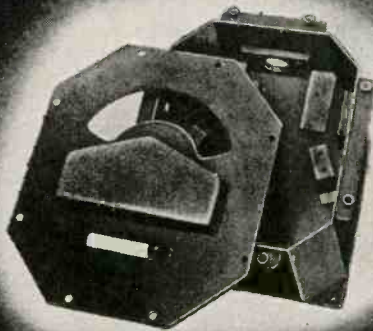
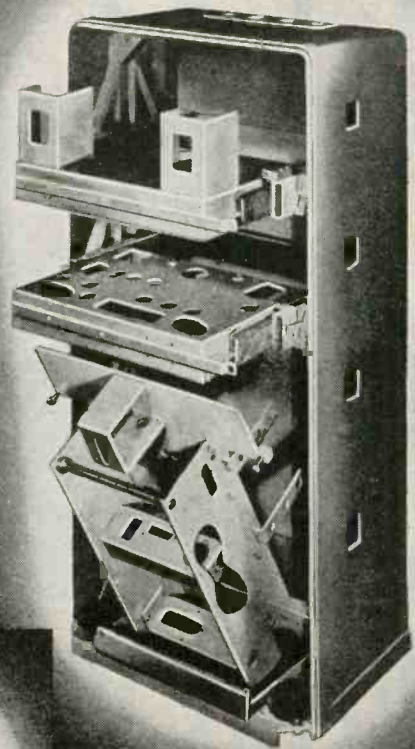
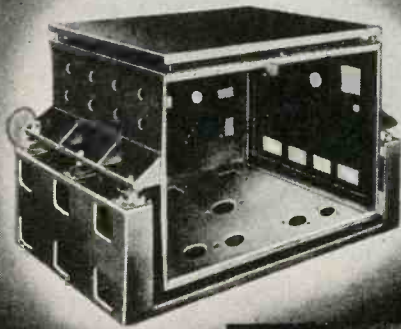

Illustrated are just a few examples of Cole Steel Equipment "know-how." Our complete stamping—welding—plating—finishing—and packing departments are at your command. Whatever your problem . . . instrument housings, water-tight boxes, chassis . . . we're geared to design, fabricate, and finish to your exact specifications.

Send for our brochure  
"THE PLANT BEHIND YOUR PLANT"

# COLE

STEEL EQUIPMENT COMPANY

349 Broadway, New York 13, New York

Factory: Brooklyn, New York

**Cole Steel  
office equipment  
will again be  
available  
after the war**



more efficient  
...in miniature



ACTUAL SIZE

The modern high speed grinder can perform many tasks that are impossible with the old fashioned grindstone. Like the miniature electronic tube, it is a striking example of the modern trend of increased efficiency with reduced size.

TUNG-SOL foresees great possibilities in the use of miniature tubes. In most circuits miniatures do a better job than large tubes. Their lower capacity and high mutual conductance and their shorter leads with resulting lower lead inductance make them practically essential for many high-frequency applications.

The added advantages of miniatures are their small size and reduced weight.

TUNG-SOL engineers will be ready to assist the manufacturers of radio sets just as they have assisted the Navy and Signal Corps by designing and planning circuits and selecting tubes best suited to give the most efficient performance. Your future plans will be held in strictest confidence.

**TUNG-SOL**  
*vibration-tested*  
**ELECTRONIC TUBES**



TUNG-SOL LAMP WORKS INC., NEWARK 4, NEW JERSEY  
Also Manufacturers of Miniature Incandescent Lamps, All-Glass Sealed Beam Headlight Lamps and Current Intermittors

than at higher levels. Or putting it another way, changing the volume—although it actually does not change the frequency response of the receiver—nevertheless gives the ear the impression that the frequency response has been changed. Nor is this effect limited to actual changes in receiver volume setting; quiet passages of music will be reproduced with apparently less bass than loud passages.

#### Circuit

The circuit incorporates automatic increase and decrease of the amount of effective bass response for loud and soft passages, introducing relatively greater bass at low volume levels than at high, thereby counteracting the ear's loss in bass sensitivity at low levels.

The circuit is shown in Fig. 1. Negative feedback in the output through  $C_3$ , by lowering the dynamic output impedance of the circuit, damps speaker-cabinet resonance which would otherwise become annoying noticeable with the increased bass response of the amplifier-speaker system.

Hum voltage from the positive high-voltage source is introduced onto the screen of the driver tube in such a polarity by the voltage divider  $C_2-C_3$  as to counteract hum voltage on the plate, thereby lowering the hum signal. This hum-bucking circuit is especially necessary in a circuit whose function is to increase the apparent low-frequency response.

Third harmonic of the fundamental—necessary to give the aural effect of the fundamental—is produced by positive feedback through the network  $R_1-R_2-R_3-C_1$ . The action of the positive feedback can best be described in reference to the dynamic plate characteristic of Fig. 2. The tube is biased at the symmetrical mid-point of its characteristic. Positive feedback from a signal that has been affected by the tube's characteristic serves to emphasize the non-linearity of this characteristic. If however the signal is so small as not to be distorted in passing through the driver, there will be no increase in non-linearity.

The accentuation of the non-

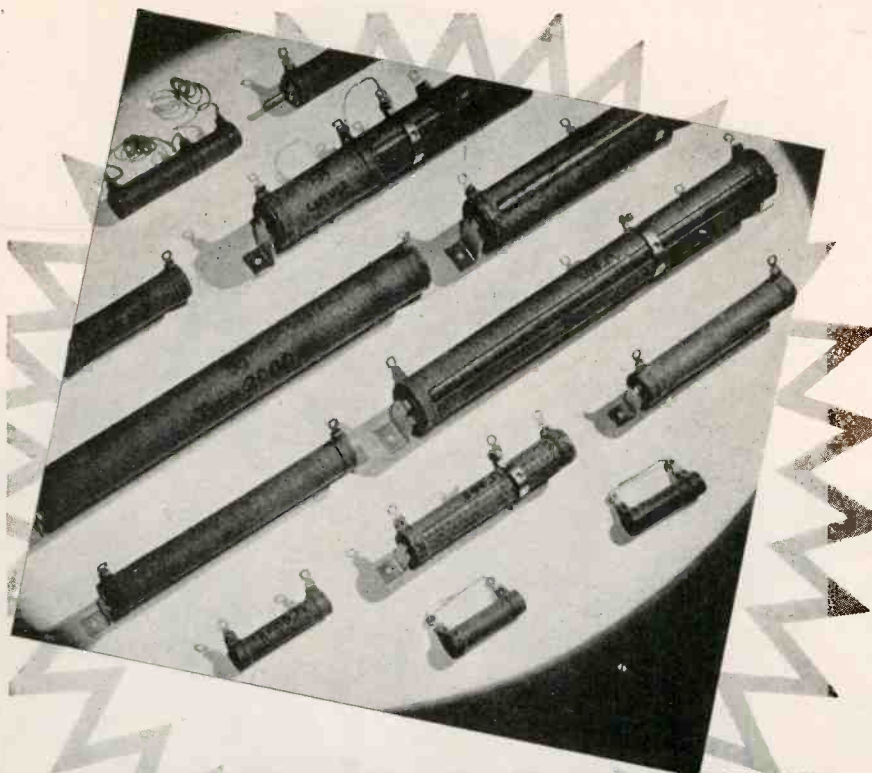

# GREENOHMS



*Products of*

**"THE HOUSE OF RESISTORS"**

Standard 10 and 20 watt fixed resistors. 1-50,000 and 1-100,000 ohms.

Standard adjustable resistors. 25 to 200 watts. 1-100,000 ohms. Brackets furnished. Additional sliders available.

Greenohms feature the exclusive Clarostat cold-setting inorganic cement coating. Won't flake, peel, crack, even under serious overload.

Greenohms can take an awful beating. Handle heavy overloads without flinching.

Available in widest range of windings, terminals, mountings, taps, etc. on special order.

★ **GREENOHMS**—those green-colored cement-coated Clarostat power resistors—definitely "stay put." You can positively bank on their resistance value. Proof? The fact that they are now found in the finest assemblies—quality instruments, radio transmitters, electronic equipment. The resistance is right to start with. And it stays right even after years of use and abuse.

Recently we had occasion to check a batch of Greenohms that had been lying around in a warehouse for years—part of one of our radio show displays. Each and every Greenohm checked "right on the nose." And they make out even better in use and under real abuse.

★ **Submit Your Problem . . .**

Tell us about your resistance or control problem. Let us provide engineering collaboration, specifications, quotations.

**CLAROSTAT**



*Controls and Resistors*

CLAROSTAT MFG. CO., Inc. - 285-7 N. 6th St., Brooklyn, N. Y.



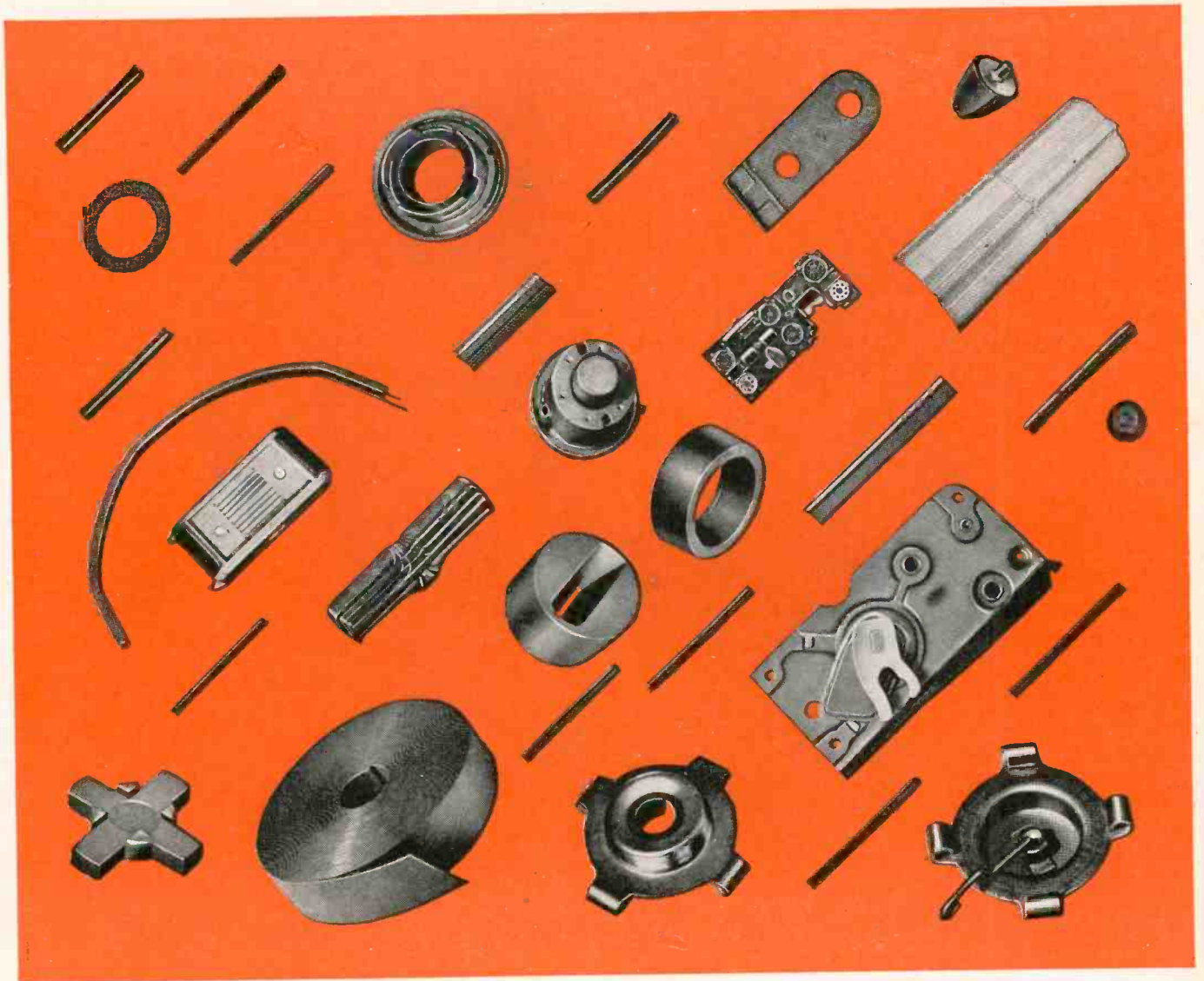

## Not everybody

**F**EW manufacturers possess the versatile production facilities of The Standard Products Company.

Standard is prepared to develop and plan for industry, parts of molded rubber, steel stampings, plastics, in almost any shape or form.

The services of The Standard Products Company Research Laboratory and Engineering Departments are at your disposal.

Let us have the necessary data and our engineers will submit designs and proposal.

The Standard Products Company is the world's largest manufacturer of glass run window channel and contour weather strip. Production and replacement channel for passenger cars, truck cabs, busses, motor boats, airplane cabins and streamlined trains is now available for delivery.

*Your inquiries are solicited.*

# THE STANDARD PRODUCTS COMPANY

*Administrative and Sales Offices*

505 Boulevard Bldg.

Woodward Ave. at E. Grand Blvd.

Detroit 2, Michigan

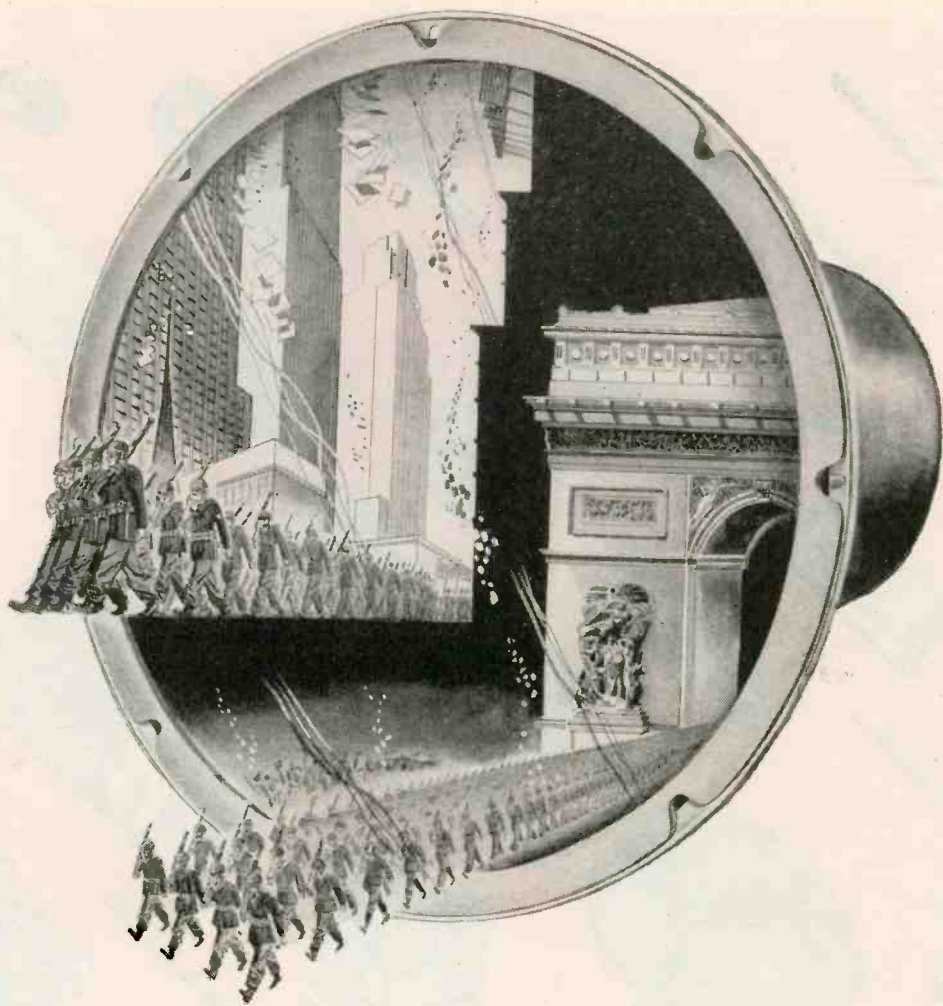

## The Loudspeaker Everyone is Waiting for

**N**O, it isn't necessarily a Rola. The sound for which the Nation is so eagerly and confidently waiting is the news that Victory is ours . . . that men and women will come home . . . that the bright dawn of world peace is in sight.

In many homes it *will* be a Rola, for millions of radio sets have been Rola equipped, but regardless of who made it, the loudspeaker that brings this welcome news will be the

sweetest sounding speaker anyone ever listened to.

Afterward will come still finer Rola speakers, improved by discoveries and developments that can't be talked about now. Meanwhile, busy as it is in highly important war work, Rola can do no more than provide speaker models for authorized experimental work and consult with Manufacturers on their peacetime plans.

THE ROLA COMPANY, INC. • 2530 SUPERIOR AVENUE, CLEVELAND 14, OHIO

# ROLA



MAKERS OF THE FINEST IN SOUND REPRODUCING AND ELECTRONIC EQUIPMENT

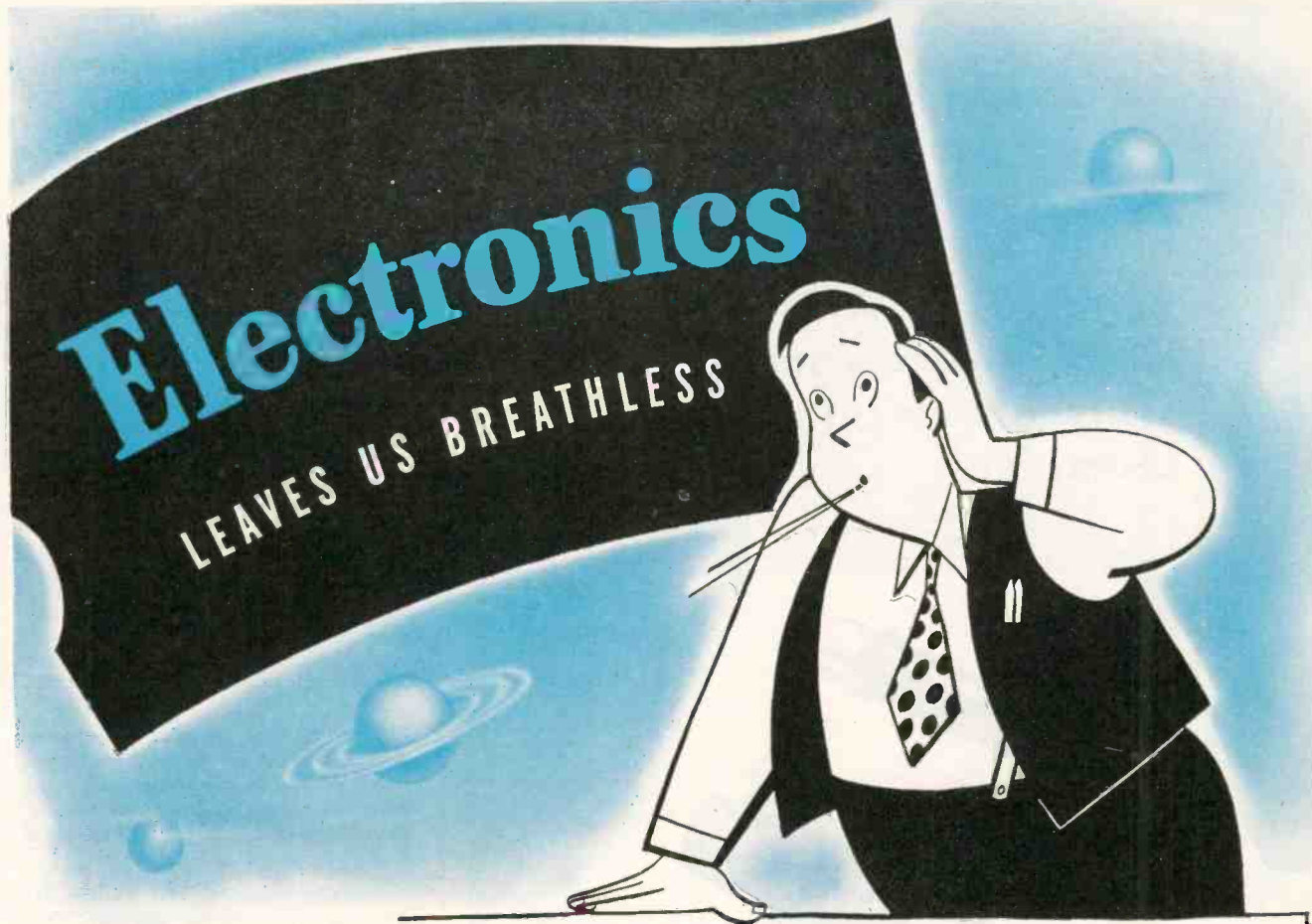

*But we can tell you about* **ALUMINUM...**

Words cannot express our great admiration for the amazing accomplishments and the future possibilities of electronics. Electronics leaves us breathless.

So, we're content to leave the designing of electronic equipment in the capable hands of those who know how.

But when it comes to using aluminum in electronic equipment, that is where we may be of real service. Alcoa Engineers

have a wealth of data and years of experience in using aluminum successfully and economically in other industries.

Whether it's a problem of light weight, strength, corrosion resistance or a question of the most economical method of fabricating parts, let us give you the benefit of our experience.

ALUMINUM COMPANY OF AMERICA,  
2136 Gulf Building, Pittsburgh 19, Pa.

**ALCOA** **FIRST IN**  
**ALUMINUM**



# RESISTANCE PLUS

From the tropics to the arctics—on land, sea and in the air, HARDWICK, HINDLE resistors and rheostats are serving with distinction.



**HARDWICK, HINDLE, INC.**  
**RHEOSTATS and RESISTORS**  
 DIVISION OF  
**THE NATIONAL LOCK WASHER COMPANY**  
 ESTABLISHED 1886  
**Newark 5, N. J., U. S. A.**

linearity of the characteristic is limited to low frequencies by making the positive feedback network a low-pass circuit. The extremely non-linear but still symmetrical

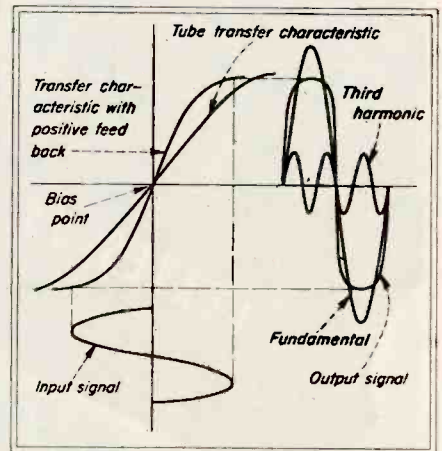

FIG. 2—Positive feedback accentuates non-linearity of the transfer characteristic, increasing generation of third harmonic necessary for aural appearance of bass response of small speakers

characteristic produced at low frequencies introduces strong third harmonics of these low tones.

To attenuate the strong low-frequency fundamental which could overdrive the speaker, the plate-grid coupling capacitor  $C_1$  is made smaller than usual. The ratio of  $C_1$  to  $C_2$  determines the shape of the apparent speaker response, especially the frequency of maximum apparent response.

### Acoustic Effect

The effect of the strong third harmonic in place of the fundamental is that, for a speaker which does not radiate low frequencies, acoustic output (taking into consideration all frequencies present in the output) is actually a rising response as frequency is reduced, thereby compensating for aural insensitivity at these low frequencies, instead of a rapidly falling response obtained if the speaker is required to radiate the fundamental. Acoustic output curves illustrating this bass synthesis and the volume-level bass compensation previously described are given in Fig. 3.

For additional information the reader is referred to two reports of the preliminary disclosure of the technique in a review of Shepard's



## HERE'S **TOPS** IN FLEXIBLE CORDS

It's DRAGGED over rough concrete, through metal shavings, grease, and water. It's coiled, twisted, and stepped on. But this tough, flexible cord stands the gaff. It's a Whitney Blake portable tool cord—approved by Underwriters Laboratories, and protected with VINYLITE plastic insulation!

The dielectric strength of this modern insulation permits the small diameter construction important to many instrument applications. And VINYLITE plastic wire and cable in-

sulation has remarkable resistance to abrasion and impact, oils, grease, alkalis, most acids, and the aging action of air and sunlight. Some types are non-flammable, others slow-burning. All remain flexible at low temperatures. Thin-wall construction permits a greater number of circuits in existing conduits — and VINYLITE plastic insulation can be made in colors for quick identification.

VINYLITE plastic insulation is bringing widespread improvements to the makers of electric and elec-

tronic equipment, public utilities, construction concerns, and manufacturers of marine, automotive, and airplane products. Adopt it for your own requirements. Write for booklet 18-VR, "VINYLITE Plastics for Wire and Cable Insulation." It's yours for the asking.

BAKELITE CORPORATION

Unit of  
Union Carbide and Carbon Corporation



30 EAST 42ND ST., NEW YORK 17, N.Y.

# Vinylite Plastics

TRADE-MARK

HOW  
ELECTRONIC CONTROLS  
PROTECT WORKERS  
ON  
INTERNATIONAL CIGAR  
MACHINERY COMPANY'S  
ROLLING MACHINES



Pictured equipment of The International Cigar Machinery Company cuts the cigar leaf wrapper. The process involving the hand operation of placing the wrapper leaf on the die on top of the turret shown in the center involves a hazard to the operator against which she is completely protected by the Photo-electric Safety Control. Its operation (shown diagrammatically) is simple and effective. The area in which hands are in danger is covered by two protective beams of light originating at (A) passing to (B) where it is reflected from an angled mirror to a similar mirror at (C) which in turn reflects it to the photo-electric cell (D). Any interruption of either of these beams automatically stops the machine and protects the hand from the pressure cutter rollers (E) moving across the die and from other moving parts. The interruption of the beam is also indicated by a monitor light at (G). The machine cannot run while the light beams are interrupted and remains at rest even after removal of the obstruction, till the operator presses reset button (F).

In addition to removal of accident hazards and attendant benefits, plants which now use this safety equipment report that the sense of security engendered in the operator has consistently stepped up production.

OTHER APPLICATIONS of United Cinephone Electronic Controls are almost without limit. If you have a problem of measuring, gauging, counting, sorting, heating, or some other operation in your plant, which is costly and unreliable, you will want to investigate the possibility of solving the problem ELECTRONICALLY. That's where our extensive experience and facilities in Electronic design, engineering, and manufacturing can be of invaluable help. Your inquiry will be welcome.

Electronic fields we cover include:

1. Industrial Controls
2. Aircraft Communications
3. Laboratory Test Equipment
4. Radio and Audio Equipment

# UNITED CINEPHONE CORPORATION

20 NEW LITCHFIELD STREET

TORRINGTON, CONNECTICUT

# Down to fundamentals...

## IN TRANSFORMER DESIGN FOR POST-WAR

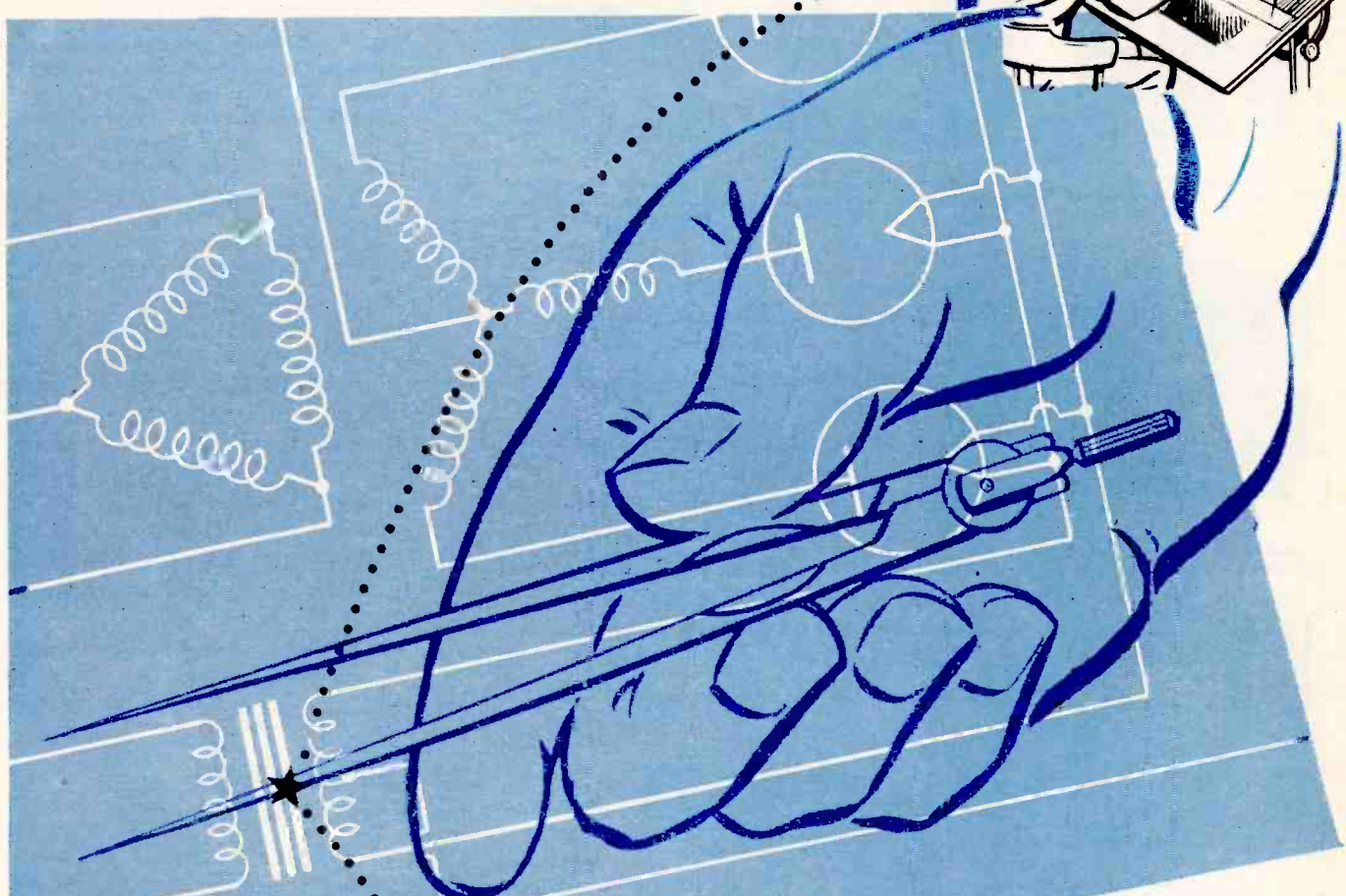

★ The product illustrated typifies N-Y-T compact designs incepted by N-Y-T for mobile, airborne and portable equipment.



### A consideration of time and cost factors!

N-Y-T engineers are now in a position to extend close collaboration in the solution of transformer, choke and filter problems—from blueprint to finished product. They are prepared to design special components for specific applications and produce them promptly at low unit cost. This unique service is made possible by the specialized engineering and production facilities of N-Y-T. Our engineers are available for consultation.

*Address inquiries to Dept. E*

**NEW YORK TRANSFORMER CO**  
26 WAVERLY PLACE, NEW YORK 3, N. Y.

# Start with any **J** Jackson Instrument to Build a Balanced Testing **TEAM!**



**Condenser Tester**  
Model 650A—Measures Capacity, Power Factor and Leakage



**Sensitive Multimeter**  
Model 642—20,000 ohms per volt—complete ranges



**Electronic Multimeter**  
Model 645—A new Jackson instrument of advanced design



**Tube Tester**  
Model 634—Uses exclusive Jackson "Dynamic" Test Method



**Multimeter**  
Model 643—1000 ohms per volt. Push key range selection

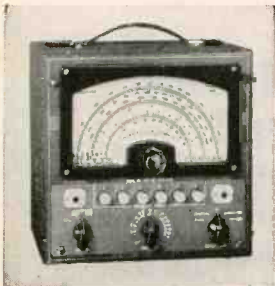

**Test Oscillator**  
Model 640—Accurate to 1/2%, covers full frequency range

It's a PLUS VALUE of the Jackson line. Each instrument is engineered and manufactured for long accurate life, as today's users know—but every one is carefully matched in appearance, dimensions and finish as well.

Start with whichever Jackson instrument you need first. Add to it as occasion demands. Your foresight will be repaid with a matched and balanced set of instruments built to give you testing results that you just can't get with hit-or-miss assemblies. Plan now to equip your shop with these Jackson instruments. See your distributor.



**Service Lab**  
Assembly of  
Standard Size  
Jackson  
Instruments

SYNTHETIC BASS

(continued)

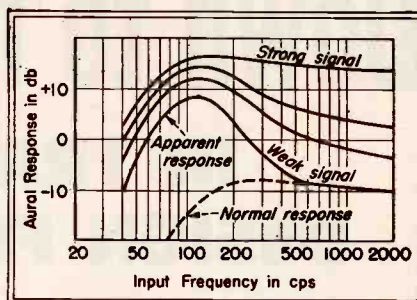

FIG. 3—Relative frequency-response curves indicate compensation for ear's change in sensitivity-frequency characteristic with intensity level and the aural appearance of notes below the radiation register of small speakers. Normal small-speaker response is shown by the dashed line; the solid lines indicate the apparent response using the synthesized bass arrangement

audio system in *Communications*, p 14, Nov 1941; and *ELECTRONICS*, p 31, Dec 1941 in which an early form of the circuit is given. The anticipated use for home radios and phonographs was reported in *Radio and Television Weekly*, p 6, April 18, 1945. Three patents (2,313,096; 2,313,097; 2,313,098) assigned to Revelation Patents Holding Co., 33 W 60th St., New York City 23, N. Y., describe the several principles of the circuit.

## Tubes Calibrate Heavy Artillery

THE BATTLE USEFULNESS of American heavy artillery was extended by new electronic equipment used by Army Ordnance teams in Italy and Germany. The test units, installed in 2½-ton trucks and transported right up to the battlefield, are capable of measuring the speed of projectiles within 1/100,000 second.

The problem was to determine the velocity or speed of the projectiles of guns and howitzers that had been in service for several weeks or months, as compared with the velocity of new artillery pieces in action for the first time. When guns of different ages are fired together at the same target, allowances have to be made for each used gun. Figures for this purpose were provided by seven ordnance calibration teams that worked on the various battlefronts.

The results so far reported show

BUY WAR BONDS AND STAMPS TODAY

# JACKSON

*Fine Electrical Testing Instruments*

JACKSON ELECTRICAL INSTRUMENT COMPANY, DAYTON, OHIO



When Wire Coils Must Be

**OVEN-BAKED FASTER**



## **FORMEX\*** *Still Won't Crack*

**because the insulation on Formex magnet wire is highly resistant to heat shock**

One way to speed coil production is to use higher temperatures and faster cycles in the baking process. Ordinary enameled wire can't stand such treatment, but Formex magnet wire can!

The superior toughness of the insulation on Formex enables it to withstand far more abuse in coil manufacture than other wires—in baking, bonding, winding, forming, and handling. This greater toughness affords you an opportunity to reduce rejects while maintaining top-speed production.

Because it needs no fibrous covering, and because it is available in rectangular and square shapes throughout a wide range of sizes, Formex makes possible more compact windings with resultant savings in weight and materials.

As the world's largest user of magnet wire, General Electric makes the same sort of comparisons of installed costs as you might make. These comparisons show that, even

in those few cases where the price of Formex is slightly higher than the price of conventional magnet wire which it replaced, the higher first cost is definitely offset by lower costs of manufacturing the completed coil or installed winding.

Ask your G-E representative to show specifically how you can benefit by using Formex. *General Electric Company, Schenectady 5, N. Y.*

*Round wire sizes: No. 8 Awg to .001 in.*

*Rectangular wire: Full range of sizes*

\*Trade-mark Reg.  
U.S. Pat. Off.

**Buy all the BONDS you can—  
and keep all you buy**

**GENERAL  ELECTRIC**

503-24-1200



# POWERSTATS

IN THE AIR  
OR ON THE GROUND

## 400 cycles

Pictured above is the new 400 cycle POWERSTAT Variable Transformer designed especially for aircraft use. This lightweight, rugged, dependable POWERSTAT type 1140 is an aircraft component where ounces count and failure cannot be tolerated. Having the features of advanced design, carefully selected improved materials and conservative ratings, the POWERSTAT type 1140 is the air-borne variable transformer. The new POWERSTAT type 1140 retains the features of the 60 cycle POWERSTATS — essential components of many types of ground and shipboard war equipment. Type 1140 is readily available for similar use on 400 cycle equipments.



### RATINGS OF UNITS ILLUSTRATED

POWERSTAT Variable Transformer Type 1140:

Input: 115 volts, 400 cycles, 1 phase.

Output: 0-135 volts, 6.5 amperes, .880 KVA.

Mounting Radius 2 1/2 inches; Overall height 4 3/4 inches.

POWERSTAT Variable Transformer Type 116:

Input: 115 volts, 50/60 cycles, 1 phase.

Output: 0-135 volts, 7.5 amperes, 1.0 KVA.

Mounting Radius 2 1/2 inches; Overall height 6 3/8 inches.

A special POWERSTAT is incorporated in the M-9 Gun Director shown on this page.



POWERSTAT TYPE 116

PHOTO COURTESY WESTERN ELECTRIC CO.

**SUPERIOR ELECTRIC CO.,** 406 Laurel St., Bristol, Conn.

SEND FOR BULLETINS LE

### "BO" POWER RELAY

The "BO" relay is an all-purpose double pole power relay. Like other Allied types it is ruggedly designed yet features compactness and minimum weight. This relay utilizes molded Bakelite insulation throughout. Contact rating is 15 amperes at 24 volts DC or 110 volts AC non-inductive. The "BO" relay can be furnished normally open, normally closed or double throw and is available for either AC or DC service. Weighs 4 ounces.

Height  $1\frac{1}{8}$ " ; Length  $1\frac{1}{8}$ "  
Width  $1\frac{13}{32}$ "

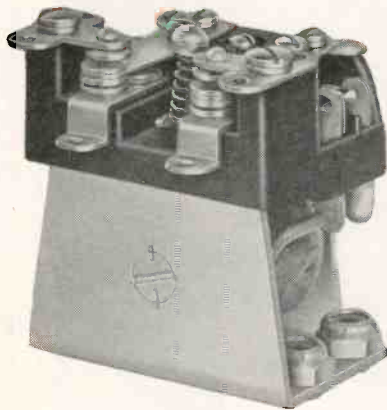

### "DO" TYPES 3 and 4 POLE

The "DO" three and four pole relay is similar in function to the "BO" type described above. It supersedes the old three and four pole type and features such modifications as simplified terminal arrangements, adjustable structure, and improved mechanical contacts, and improved mechanical structure. By using molded Bakelite insulation throughout, greater electrical clearance is provided. Contacts are rated at 15 amperes at 24 volts DC or 110 volts AC non-inductive. Can be furnished normally open, normally closed, double throw and for AC or DC service as specified. Weight for three pole type 7 oz., four pole  $7\frac{1}{2}$  oz.

Three pole Height  $2\frac{1}{4}$ " ; Length  $1\frac{1}{8}$ " ; Width  $1\frac{1}{8}$ " ; Four pole Height  $2\frac{1}{4}$ " ; Length  $2\frac{1}{16}$ "  
Width  $1\frac{1}{8}$ "

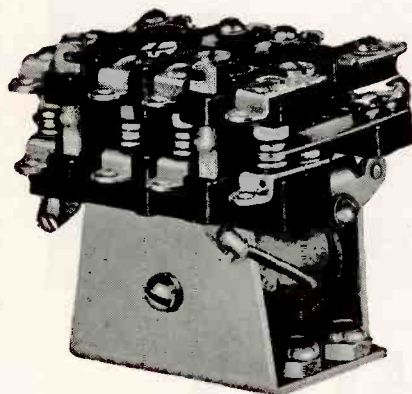
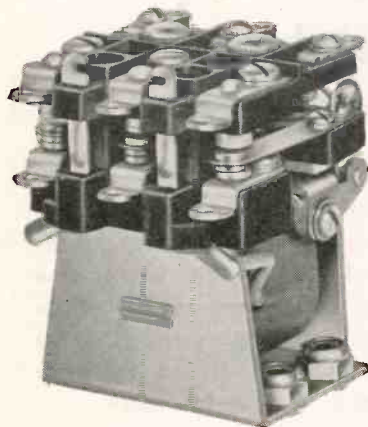

## constant progress MARKS ALLIED RELAY DESIGN

Marking time or "resting on laurels" in no way reflects Allied's engineering and business philosophy. A specific control does a good job . . . but can it be improved? Allied engineers and field staff check its working performance . . . seek possibilities to better or broaden its usefulness.

Thus refinements, revisions and modifications in basic types of relays come about—as in the three and four pole "DO" and the all-purpose double pole "BO" types described herein. Keeping pace with the constant engineering progress of manufacturers whose products require electrical control . . . anticipating their requirements . . . epitomizes Allied's philosophy. Let your control problems become our engineering projects.



## ALLIED CONTROL COMPANY, INC.

GENERAL OFFICES: 2 East End Ave. (at 79th St.) New York 21, N. Y. Factories: New York City (2 East End Ave.)—Plantville, Conn. Chicago—4321 Knox Avenue, Chicago 41, Illinois. In California: Allied Control Co. of California, Inc. 1633 South Hope St., Los Angeles 15, Calif.

*Post-War Performance!*

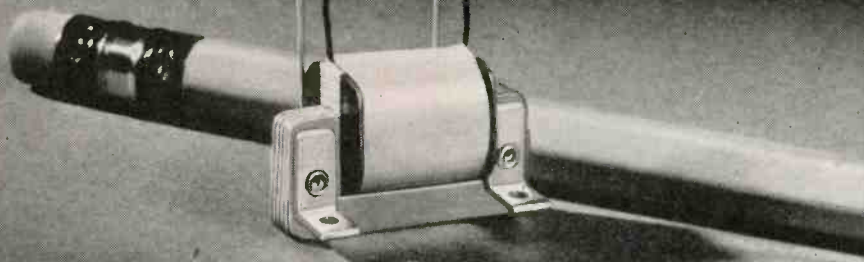

**Permoflux Midget Transformers Conserve Vital Space and Weight!**

• Because of their exceptional operating efficiency and uniform frequency response characteristics, Permoflux midget transformers have literally hundreds of practical applications where size and weight are determining design factors. Developed by Permoflux engineers, with new materials and manufacturing methods, they are available unshielded, shielded or hermetically sealed for your specific requirements. Why not let us design a unit for you?

### Permoflux Speakers Assure the Best in Tone Reproduction

Their wide frequency response, extreme sensitivity and rugged mechanical design have established new concepts of tone realism. Permoflux speakers in sizes from 2" to 15", with power handling capacities from 1 to 20 watts, are available for your post-war developments.

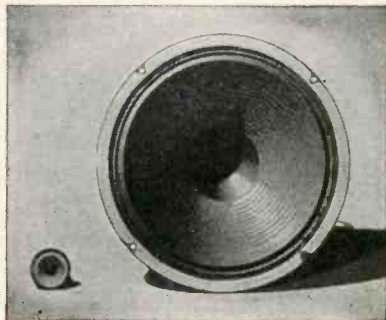

TRADE MARK  
**PERMOFLUX**  
 PERMOFLUX CORPORATION  
 4900 WEST GRAND AVE., CHICAGO 39, ILL.



PIONEER MANUFACTURERS OF PERMANENT MAGNET DYNAMIC TRANSDUCERS

that the life of gun tubes is much longer than previously assumed. In the past, gun crews discarded gun tubes rather frequently because they had no knowledge of the efficient life of a tube and could not afford to take chances. The electronic calibration units supply data on the condition of the tubes and helps reduce the artillery supply problem so serious in the Pacific.

• • •

### Postwar Prospects for Modulated Pulse Transmission

AFTER NINE YEARS of research, pulse time modulation (PTM) has been announced by Federal Telephone and Radio Laboratories. The new system makes it possible to broadcast as many as 12 different programs simultaneously from a single radio transmitter operating on one frequency channel.

At the same time that it effects economy in transmission and simplifies and improves the efficiency of reception, it provides static-minimized reception of sound broadcasting.

Pulse time modulation receivers receive all radio programs on one frequency channel and are equipped with pushbutton circuits to separate each program after it is received. PTM transmissions differ enough from static to permit a PTM receiver to filter out noise.

The new system has been named PTM because the radio signals are transmitted in the form of short pulses, accurately timed. The time intervals between pulses in the new system, since it operates on very high frequencies, are extremely minute. Insertion of separate synchronizing pulses permits more than one program to be transmitted on a single channel. Reception of a particular program is accomplished by synchronizing the receiver through this pulse. Other programs, transmitted with differently synchronized pulses, are received by readjusting the synchronization in the receiver.

#### Advantages

Pulse time modulation is expected to have an application in tel-

Schweitzer

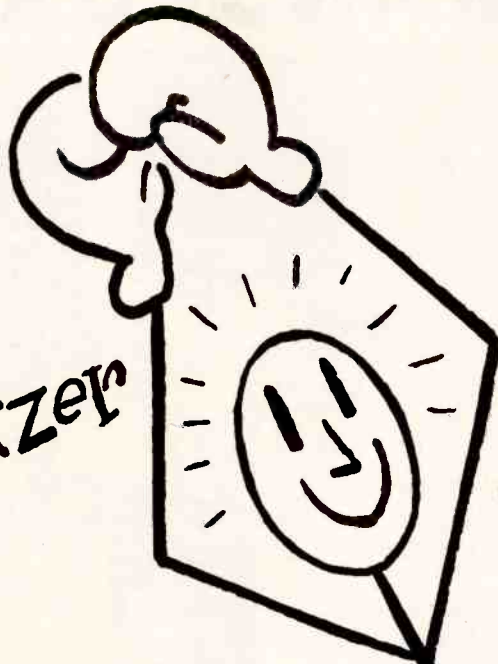

a leading  
contender  
in the  
**Light-Weight**  
class

Schweitzer is a specialist in the manufacture of thin gauge insulating papers designed to fit the small housings necessary for war and post-war equipment. If you have a problem involving the use of thin gauge insulating paper, perhaps one of our regular grades will be the answer...if not, our research laboratories will cooperate in finding a solution.

**SCHWEITZER PAPER CO.**

142 MILLER STREET, NEWARK, N. J.  
Plants: Newark, Jersey City, N. J.; Mt. Holly Springs, Pa.  
Research Laboratories: Chrysler Bldg., New York, N. Y.

SPECIALISTS IN **THIN GAUGE** INSULATING PAPERS

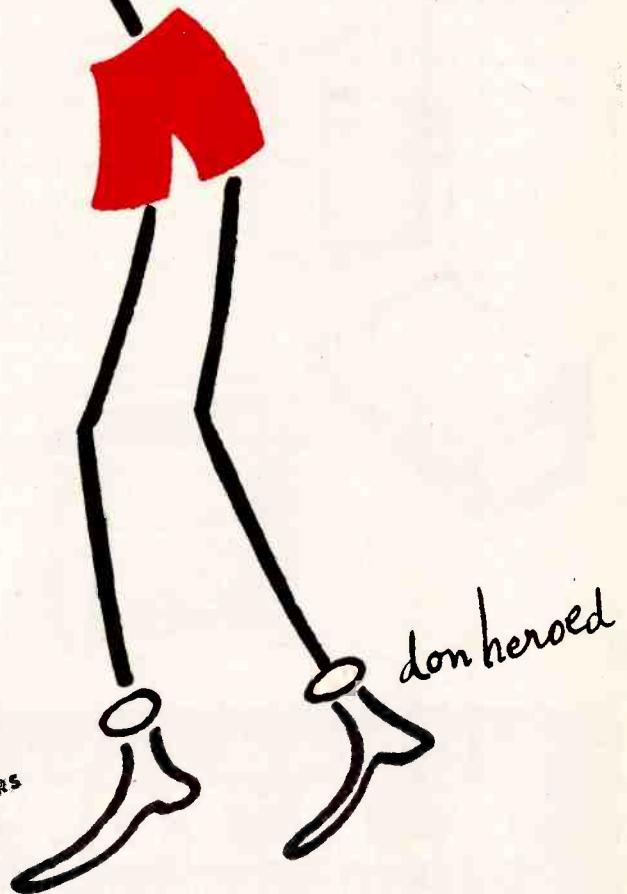

# FOSTER TRANSFORMERS

## AVAILABLE NOW!

Facilities for peacetime manufacture of transformers are already available at A. P. Foster, and, as war commitments are filled, will be increasingly at your service.

During the war years A. P. Foster has supplied thousands of custom-designed and custom-built transformers to all branches of our armed services, for use in all parts of the world under great extremes of climatic condition.

High production schedules have been maintained by advanced Foster manufacturing techniques. High standards of performance were demanded, achieved and will be maintained—to the benefit of America's peacetime economy.

As your own reconversion plans advance from the conference stage to the blueprint stage, it may well be worth your while to bear in mind that Foster engineers and designers are ready now to consult with you on every transformer problem and to furnish estimated costs and delivery schedules on experimental or quantity production of standard transformers or special jobs custom-built to your own specifications.

● BOB REID, 810 West 57th Street, Indianapolis 5, Ind., Telephone Broadway 2725

● BAUMAN AND BLUZAT, 2753 West North Avenue, Chicago 47, Ill., Telephone Humbolt 6809-10-11-12

● THE A. P. FOSTER COMPANY, BARRITT BORDER, 11 W. 42nd St., New York 18, N. Y., Telephone PENnsylvania 6-9133

SPECIALISTS IN BUILDING TRANSFORMERS SINCE 1938

# A. P. FOSTER COMPANY

TRANSFORMER ENGINEERS & MANUFACTURERS

719 WYOMING AVENUE, LOCKLAND 15, OHIO (SUBURB OF CINCINNATI)



# Heat Resistant Glasses

for glass to metal sealing

We offer you the services of an expert staff of glass technicians who have a pre-war background in the manufacture of special purpose glasses, and a war-born experience and performance record in meeting critical tolerance requirements for special shapes to exacting physical, electrical and chemical specifications.

ZENITH  
OPTICAL  
COMPANY

*A unit of*

**Polan**  
*Industries*

Your inquiry will  
receive our prompt  
attention.

HUNTINGTON 19 • WEST VA.



elevision, since both the video and audio signals may be transmitted on the same carrier, thus effecting economy in transmitting equipment and the amount of space occupied in the frequency spectrum. Where radio signals are repeated a number of times—as in network broadcasting—or in long-distance radio relaying—efficiency is improved and operating difficulties are minimized with PTM because signal distortion is not cumulative, as it is with conventional methods.

Deloraine, E. M. and Labin, E., Pulse Time Modulation, *ELECTRONICS*, p. 100, Jan. 1945.

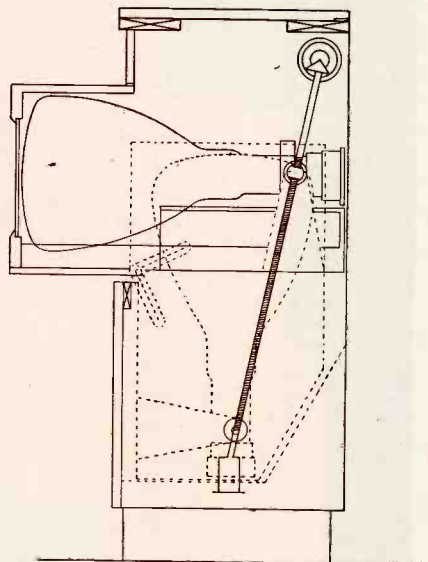

A retractable c-r tube is featured in the television receiver recently announced by Allen B. DuMont Laboratories. It works as shown above, controlled by pushbutton through a motor drive. Appearance of the 20-in. teletset, a-m/t-m, and phonograph combination is as below. Also shown was a projection model of similar design which threw a 3 by 4 ft picture

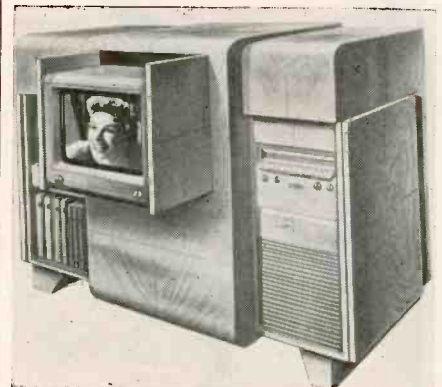

**TELEX**  
Presents New  
**"EVERY SYLLABLE"**  
*Clarity*  
For Postwar Magnetic Receivers

New wonder of the scientific world is today's mastery of the reception and control of sound communication through electronics.

It is noteworthy that in this almost magical field TELEX continues to lead the way with midget Magnetic Receivers that set new standards in high-fidelity reception and "Every-Syllable" clarity.

From TELEX Laboratories came the first wearable vacuum tube crystal hearing aid to provide hitherto unobtainable, near natural, balanced hearing for the deafened.

All through the war, as you would expect, TELEX has furnished the Signal Corps thousands upon thousands of midget Magnetic Receivers for grueling combat uses.

From lessons learned through this rich experience, TELEX today continues to pioneer with the newest and most advanced refinements and improvements in Magnetic Receiver construction and application.

For such postwar products as wearable radios, airport and airplane receivers, I. C. systems for railroads, telephone equipment, dictating equipment, medical equipment, sound research equipment, can you use the high sensitivity and complete, brilliant clarity possible under all atmospheric conditions with TELEX Magnetic Receivers?

Should you anticipate such a need, the demonstrated, creative ability of TELEX Engineers can be of invaluable assistance.

**TELEX INC.**

ELECTRONIC PRODUCTS DIVISION  
MINNEAPOLIS 1, MINNESOTA



# heard about this coming new FARM TYPE RADIO BATTERY?

**SAME SERVICE LIFE**

**30% SMALLER  
30% LIGHTER**

**OLD**

**NEW**



No. 748 1½-volt "A," 90-volt "B" A-B Pack.  
Dimensions, 15 13/16" x 6 15/16" x 4 15/32"  
Weight, 23 lbs., 11 oz.



No. 758 1½-volt "A," 90-volt "B" A-B Pack.  
Dimensions, 10 11/16" x 6 13/16" x 4 1/8".  
Weight, 16 lbs., 13 oz.

IT WILL be much more than just a "smaller" battery! For the first time, an "Eveready" "Mini-Max" B battery will become part of a farm-type radio A-B Pack. As a result, you're going to see a 30% smaller, 30% lighter "Eveready" "Mini-Max" farm type battery pack with the same service life as the conventional pre-war packs, such as our own "Eveready" No. 748 A-B Pack.

Think what this means! Smaller, less expensive radios . . . more easily carried from room to room . . . can be built around it. Or farm radios of present-day size with larger, better speakers using space formerly taken up by bigger batteries having no greater service life.

These and other advantages will mean more profits in both radio and battery-pack sales for you!

The name of the battery is "Eveready" No. 758 A-B Pack. It will take its place on a growing list of startling

postwar "Eveready" batteries...based on National Carbon's exclusive principles of battery construction as used in the "Mini-Max" battery.

**"EVEREADY"**

TRADE-MARKS

# MINI-MAX

**RADIO "B" BATTERIES**

**NATIONAL CARBON COMPANY, INC.**

Unit of Union Carbide and Carbon Corporation

**UCC**

General Offices: NEW YORK, N. Y.

The trade-marks "Eveready" and "Mini-Max" distinguish products of National Carbon Company, Inc.

# THE ELECTRON ART

Calculation of Distortion Due to Phonograph Needle Wear... 250  
 Subsurface Prospecting for Hydrocarbon Oil Sands..... 252  
 Five Radio-Frequency Bridge Circuits..... 264

## Calculation of Distortion Due to Phonograph Needle Wear

THE DEGREE OF DISTORTION and loss of highs as a result of phonograph needle wear are discussed in considerable detail by B. B. Bauer of Shure Brothers in the *Journal of the Acoustical Society of America*, for April, 1945. Emphasis is placed on the fact that the needle does not long remain spherical but tends to develop "flat" spots at the point of contact with the record groove. Most theoretical papers on this problem have assumed that the needle has a spherical point which does not change with use.

It is pointed out that a spherical point initially penetrates into the surface of a shellac record to a

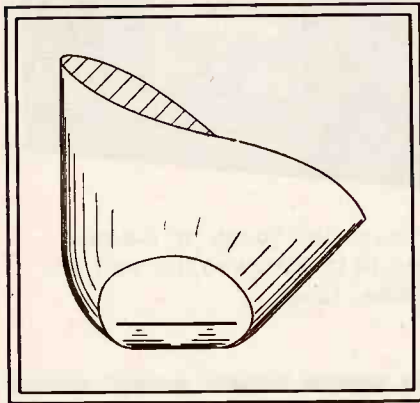

Fig. 1—Side view of worn needle point, showing the flattened portion

depth of approximately 0.0001 inch under a pickup force of one ounce. After a few revolutions of the record, there is considerable abrasion at the portion which presses most deeply into the record and this tends to even out the spherical surface. Because of the pivoting of the tone arm, the flat exhibits a slight curvature.

Difficulty was had in measuring the size of the flat since there is no sharp line of demarcation between the worn section and the spherical portion. The method finally adopted consisted of directing a distant

source of light perpendicularly to the flattened portion and observing the needle tip under a medium power microscope (100 to 200 $\times$ ). Light is reflected from the worn surface as a straight line which is measured using a calibrated eyepiece. The width of the flat can be determined with a precision of 0.0002 to 0.0003 inch. The side view of a typical needle point with a 0.0025-inch flat is shown in Fig. 1.

The size of the flat developed on three needles of different types as a function of the playing time is shown in Fig. 2. Popularly priced 10-inch commercial shellac records and one-ounce pickups were used. It was noted that considerable variation existed within a class because of the use of different alloys, jewels, etc.

### Method of Analysis

A technique similar to that used by Pierce and Hunt<sup>1</sup> was used for analysis. In this method, the mo-

tion imparted to the needed point by each groove wall separately was studied. The results were then combined later to obtain the complete equation of motion. As a result of mathematical analysis, it was found that distortion attains very large values before there is a substantial reduction in the output level of the fundamental component. This contradicts the common belief that the principal effect of needle wear is a loss in high-frequency response.

Fourier coefficients for calculation of needle wear distortion are

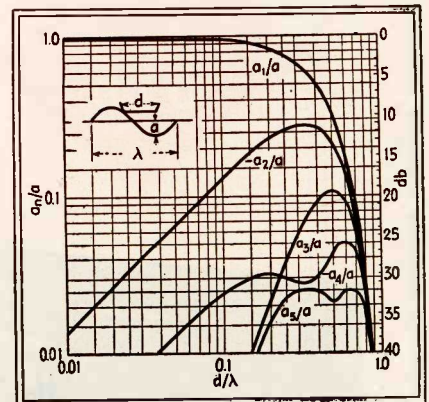

Fig. 3—Fourier coefficients for calculation of distortion due to needle wear

given. These indicate that the distortion due to needle wear in a hill-and-dale system is of the same nature as that which occurs at a single side wall. Similarly, the same

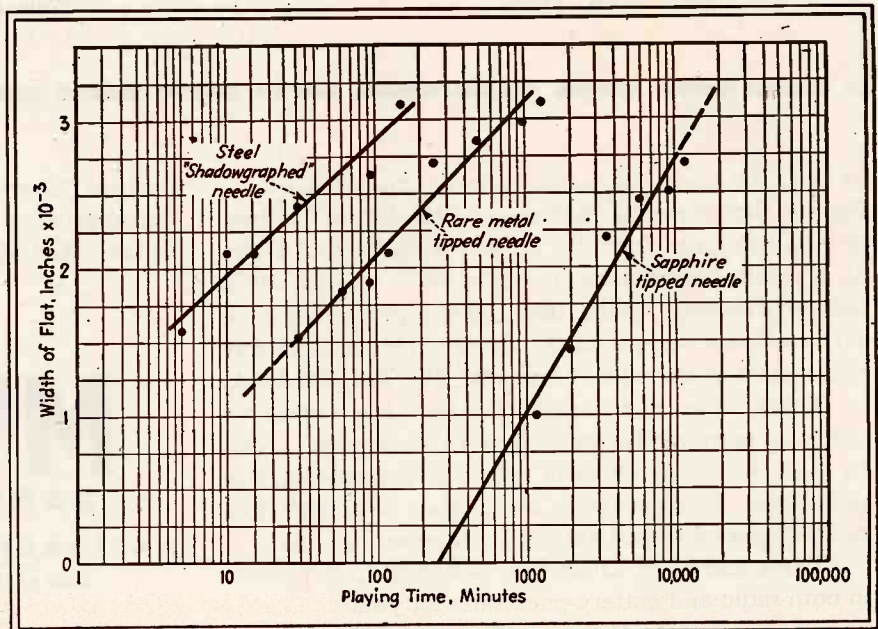

Fig. 2—Needle wear as a function of playing time measured on three different needles

# OHMITE RHEOSTATS and RESISTORS

IN  
200 KW

## Bethany Transmitters

From six of the world's mightiest shortwave stations, the "Voice of America" shoots "bullets of truth" to combat enemy lies. These transmitters, 200 KW each, located in Bethany, Ohio, were designed and built for the OWI by the Crosley Corporation.

The two interior photo-views of one transmitter reveal more than 60 Ohmite Resistors of various sizes . . . and one Ohmite Tandem Rheostat assembly.

The knowledge and experience that enabled Ohmite to "produce" on this psychological warfare job is at your service in solving resistance problems . . . today and post-war.

**OHMITE MANUFACTURING COMPANY**  
4816 FLOURNOY ST. • CHICAGO 44, U.S.A.

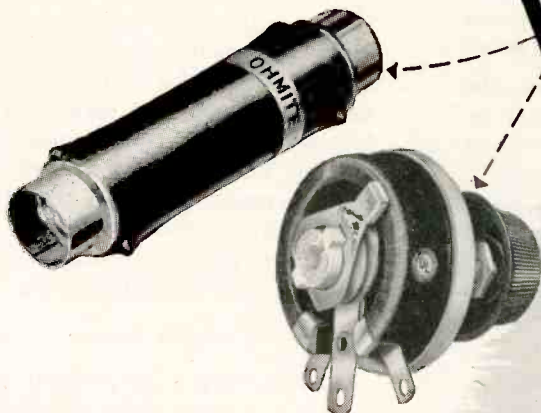
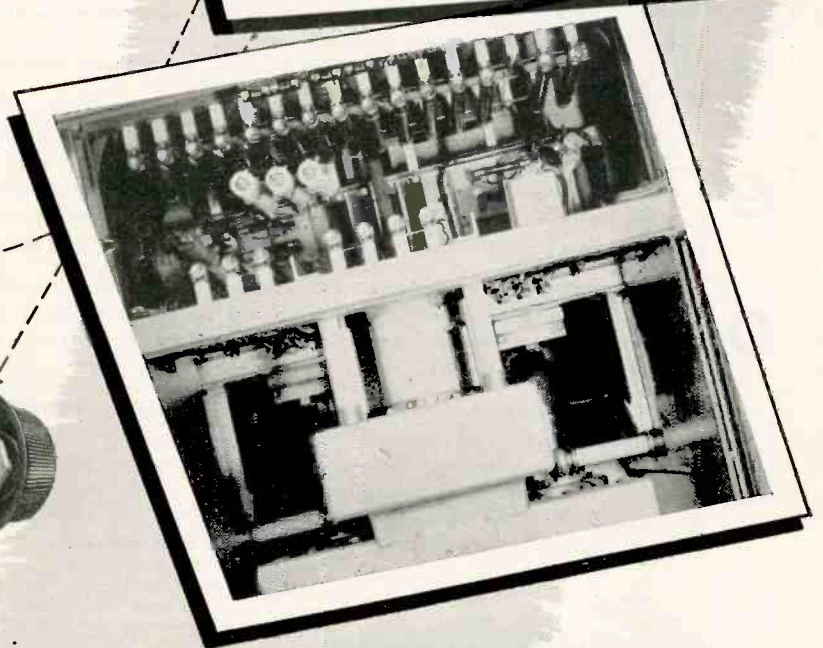
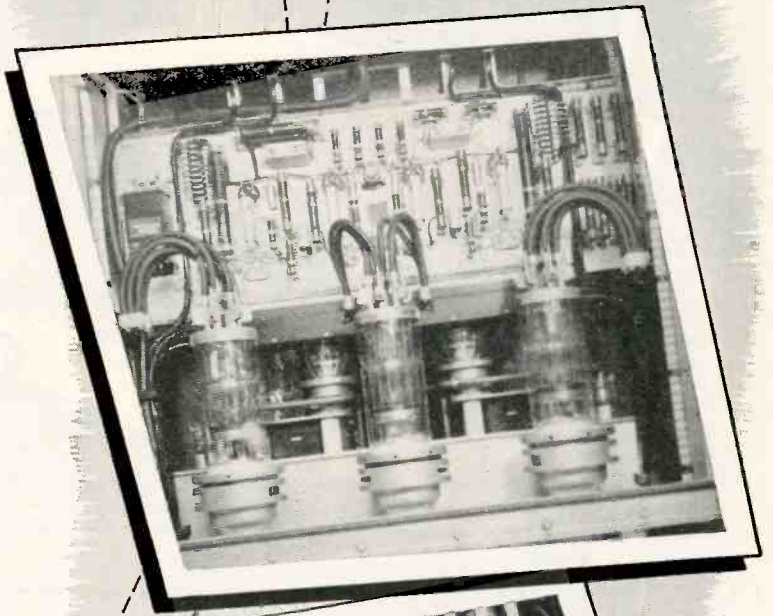

Write on company letter-head for helpful Catalog and Engineering Manual No. 40. Gives valuable data on resistors, rheostats, tap switches, chokes and attenuators.

Be Right with **OHMITE**  
RHEOSTATS • RESISTORS • TAP SWITCHES

FOR SPECIALIZED  
ELECTRONIC EQUIPMENT  
RELY ON ANDREW CO.



The fine electronic instruments shown above are examples of the precision production that characterizes all ANDREW equipment. Designed and built by skilled engineers, ANDREW CO. electronic equipment is used the world over wherever specialized apparatus is needed.

**1** TYPE 40A PHASE METER—This direct reading, precision instrument measures in degrees the phase angle between currents in radiating elements of a directional antenna system. It operates on a signal input of only 200 millivolts and may also be used for general laboratory work.

**2** TYPE 291 HF OSCILLATOR—This portable battery operated oscillator is used for checking high frequency receivers, especially aircraft type. The frequency range is from 49 to 154 Mc. with modulation frequencies of 70, 90, 400, 1300 and 3000 cycles. This unit contains a collapsible whip antenna for checking receivers without direct connections, and provides 2 coaxial terminals for low and high level output.

**3** TYPE 708 REMOTE ANTENNA AMMETER—This unit contains a diode rectifier with a DC micro-ammeter calibrated in RF. amperes, and is used for indicating antenna current at a point remote from the antenna. This instrument is used by hundreds of broadcast stations.

**4** TYPE 760 ANTENNA TUNING UNIT—This is used for coupling several antennas into a single receiver, or for coupling a single antenna into a number of receivers. Containing six RF amplifiers with an associated power supply, each amplifier stage in this unit has low impedance input and output circuits. These may be series connected for use with a single receiver or antenna. This equipment is especially useful where antennas are remotely located from receivers.

Send in your orders now so that you may receive early delivery as soon as military restrictions are lifted.

**ANDREW CO.**

363 East Seventy-fifth Street, Chicago 19, Illinois

type of distortion in a lateral system is like that in a single side wall, except that even harmonics tend to cancel out. Such cancellation could not be perfect unless the two needle flats are identical.

Calculations are carried out in some detail using Fig. 3 in estimating distortion. Measured values of distortion compare favorably with those calculated.

### Subsurface Prospecting for Hydrocarbon Oil Sands

AN INSTRUMENT for determining the presence of hydrocarbon oil sands or oil bearing formations by electronic means is the subject of a patent issued to Donald G. Hare of Houston, Texas, and assigned to Texaco Development Corporation.

In the proposed method, fast neutrons are caused to be emitted and passed into the formation around a hole drilled in the earth. Some of the neutrons after being scattered in the formation return to the surveying device to cause an indication of the variation in the types of formation through which the hole is drilled. A source of penetrative gamma rays which may be associated with a neutron source is lowered into the hole and these rays are scattered by the formations through which the hole has been drilled, a certain number of these rays then returning to the instrument.

The instrument is provided with a suitable detector such as a Geiger-Muller counter or ionization chamber. The amount of radiation scattered back to the instrument will vary with the type of formation adjacent to the instrument according to well known physical laws and thus by measurement of the intensity of this scattered radiation, information may be obtained as to the nature of the formations.

#### Emission Source

The surveying instrument comprises a substantially closed casing which is arranged to be lowered and raised through the hole. The casing contains a suitable source of gamma rays and neutrons such as a tube in which is sealed a mixture of a small amount

# TURBO earns its wings in the Aircraft industry

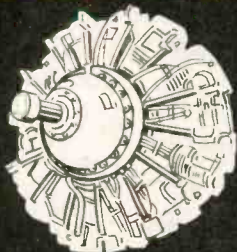

**VARNISHED GLASS TUBING:** provides a solution for motor wiring and cabling subjected to high ambient temperatures. Dielectric strength is high and mechanical properties are unimpaired in unventilated applications.

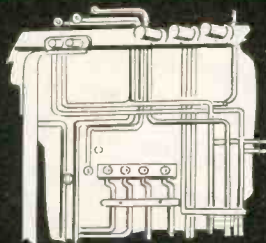

**TURBO SLEEVINGS:** simplify service and repair of complex equipment. A full range of vivid colors are available. Identification and tracing is simplified—service and repair is expedited.

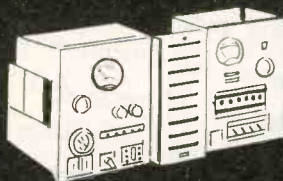

**WIRE IDENTIFICATION MARKERS:** are available in two types—tab and sleeve—these markers are easily applied and assure permanent legibility. Supplied in any color and marking, they permit instant identification of cables, tubing, and control rods.

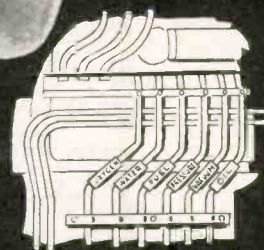

**EXTRUDED TUBING:** is a smooth wall sleeving capable of withstanding the rigors of extreme low temperatures. Immunity to embrittlement at sub-zero temperature assures safety and dependability.

## ...and proves its outstanding dependability in every type of critical electrical installation!



The exceptional functional suitabilities of TURBO insulation sleeveings are exemplified in airborne installations offering specific characteristics for meeting diversified requirements of altitude and climate. They are available in four types.

Equipment wiring solutions—radio, control, communications, etc. involving sub-zero temperatures—are effected by TURBO Extruded Tubing. This material is immune to embrittlement in severe cold, retains dielectric strength and flexibility. It is unaffected by vibration or mechanical shock, and is available in a diversity of sizes.

Other products importantly utilized in the aviation field are Varnished Glass Tubing for resistance to high heat, and Flexible Varnished Oil Tubing for use in the presence of chemicals, vapor, humidity and moisture. Identification Markers are also widely applicable for visual identification of pipes, tubing, control rods, cables, etc. Thus, by the extensive use of these insulation products for extremely critical requirements, TURBO is recognized for its dependable attribute in all fields of electrical endeavor. Write for the free TURBO Sample Board with specimens and sizes of each.

## WILLIAM BRAND & COMPANY

TURBO OIL TUBING AND SATURATED SLEEVING • VARNISHED CAMBRIC • PAPER AND TAPE • MICA AND MICA PRODUCTS  
276 FOURTH AVENUE, NEW YORK 10, N. Y. 325 W. HURON STREET, CHICAGO 10, ILL.

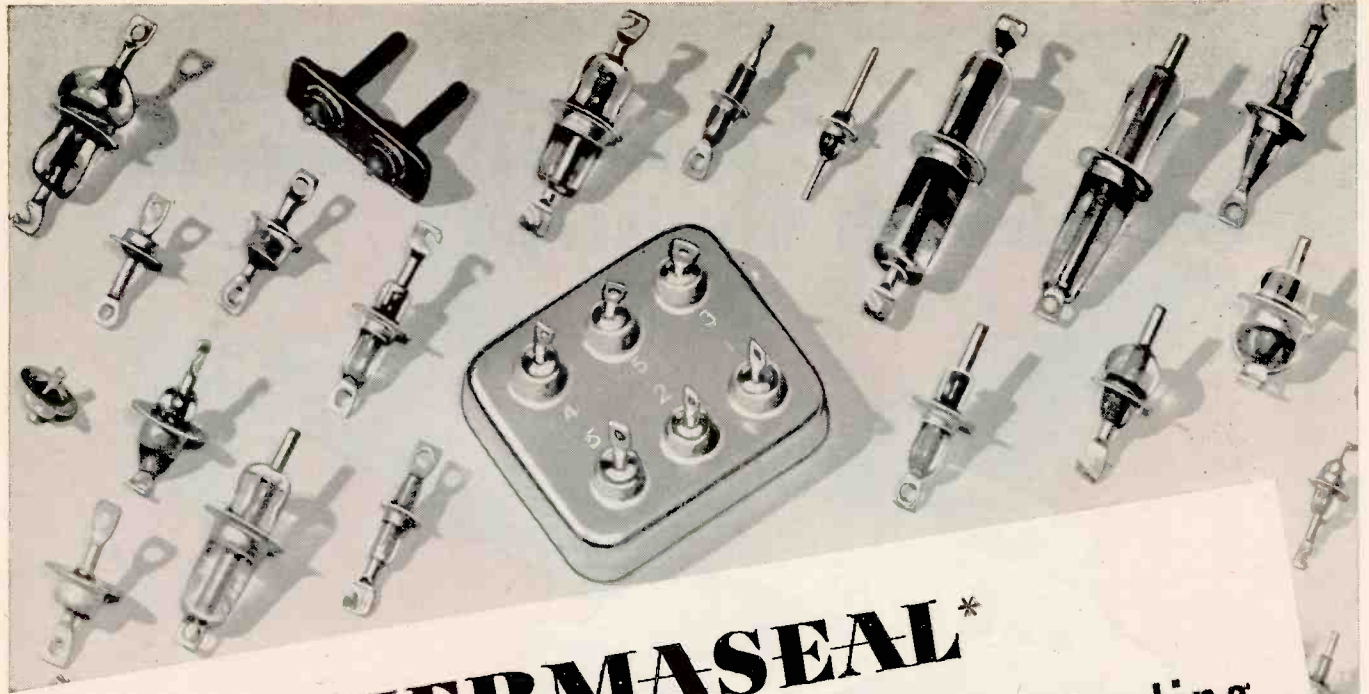

# HERMASEAL\*

## For TRUE and PERMANENT Hermetic Sealing

Literally hundreds of different types of glass and metal seals have been engineered by HERMASEAL to meet today's exacting demands for military electronic equipment. • HERMASEAL engineers have been actively engaged in the solution of glass and metal seal problems for the last 17 years and have pioneered many of today's accepted standards in hermetically sealed enclosures. • We specialize in building seals to meet the manufacturer's requirements; however, accepted standard seals are available for immediate delivery. Let HERMASEAL solve your problem of hermetic sealing whether it be relays, coils, capacitors, transformers or instrument equipment. For fast action write, wire or call!

**THE HERMASEAL COMPANY • Riverside Drive, Elkhart, Indiana**

\* Trade-mark

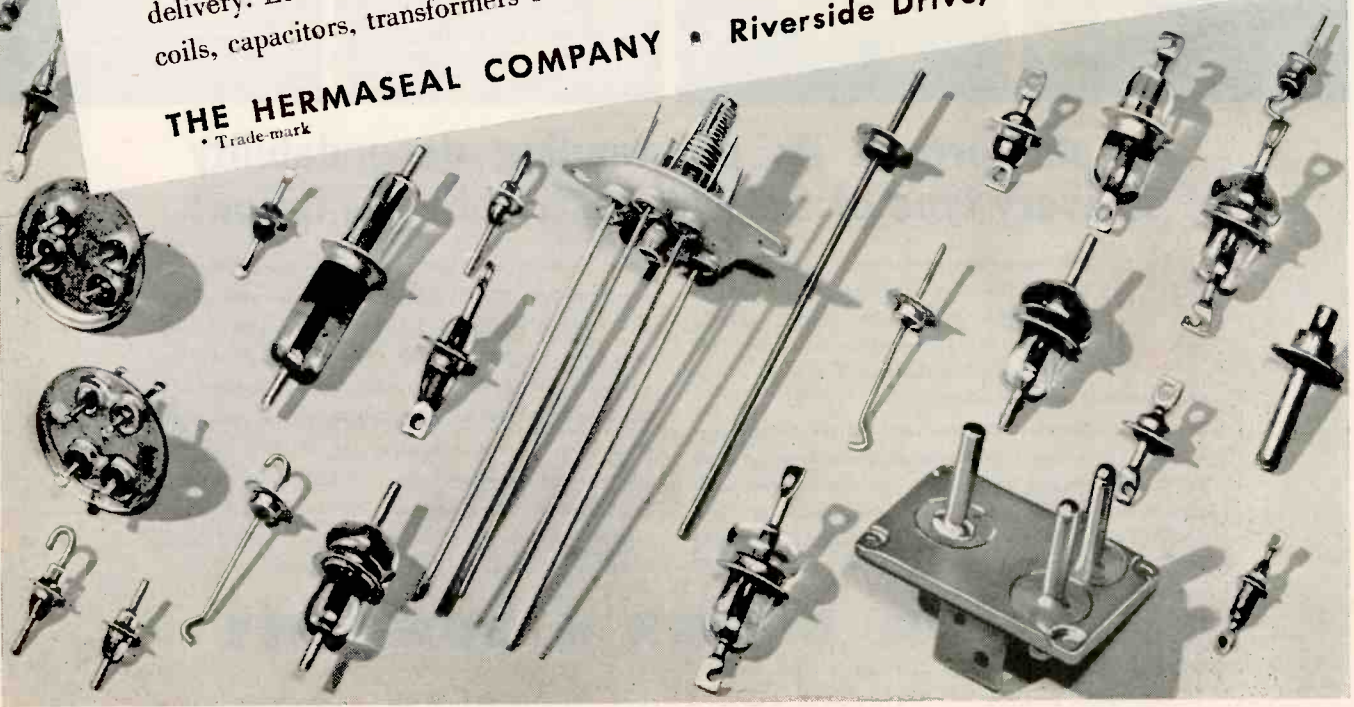

*Announcing the New*

# **BALLENTINE RECORD CHANGER**

The BALLENTINE Changer is engineered to provide trouble-free, dependable operation, safe from careless or accidental usage. It is the result of exhaustive research, expert technical design and skilled craftsmanship. The BALLENTINE Record Changer assures complete customer satisfaction, free from mechanical annoyances so frequently found in ordinary record changers. Available in three models to fit your requirements.

**RUSSELL ELECTRIC COMPANY**

364 W. Huron Street, Chicago 10, Illinois

*Manufacturers of*

**BALLENTINE RECORD CHANGER**

of a radium sulfate or chloride and a considerably larger quantity of finely powdered beryllium metal. A detector for the detection of gamma rays only is also disposed within the casing and is separated from the source by a suitable shield of lead.

The detector used for detecting gamma rays to the exclusion of neutrons may be such a device as a Geiger-Muller tube, operated at a potential sufficiently high so that the electrons emitted by the inter-

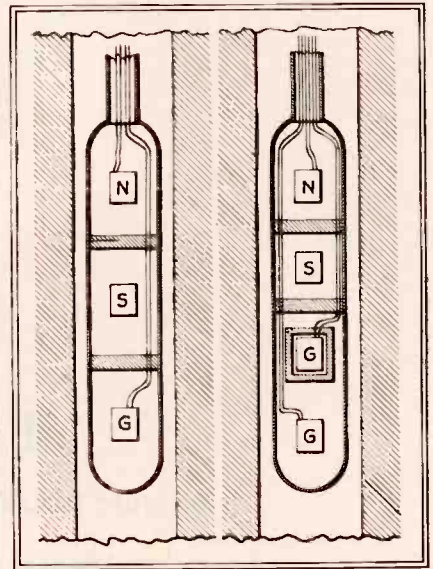

Two devices for lowering into bore holes for determining the nature of the surrounding earth formation. A source of gamma rays and neutrons, S, produces emissions which are picked up by detectors N and G

action of a gamma quantum with the tube wall will cause the tube to discharge. Within the upper part of the casing is a detector adapted for the detection of neutrons only and this detector is also separated from the source by means of a shield. The shields tend to prevent direct radiation from the source from reaching the two detectors. The shield for preventing neutrons from passing directly from the source to the detector may, if the detector is such as to respond to slow neutrons only, be a sheet of cadmium or other substance or a combination of cadmium and boron having a high capture cross-section for slow neutrons.

If desired to have the detector respond to both fast and slow neu-

**MOTOR DATA**  
No. 125

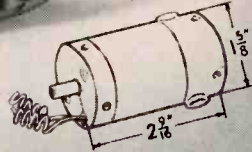
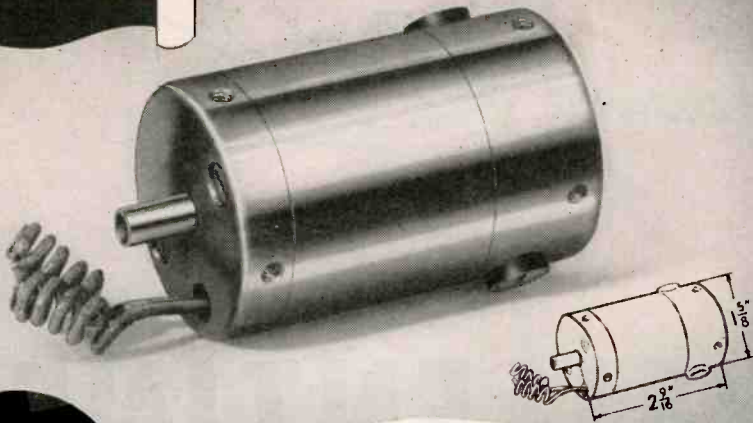

**EICOR 1600 FRAME MOTOR**  
Torque 4.5 in. oz. at 5800 RPM

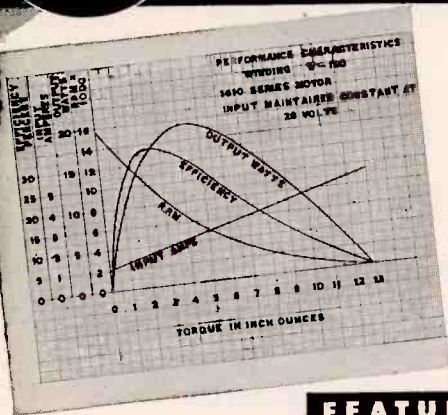

The power output of this precision motor is exceptionally high in proportion to its light weight and small size. Originally developed for numerous aircraft and portable applications, the characteristics of its performance can readily be modified for a variety of new uses.

**FEATURES**

- |                               |                               |                   |   |
|-------------------------------|-------------------------------|-------------------|---|
| ↓                             | <b>ELECTRICAL</b>             | <b>MECHANICAL</b> | ↓ |
| Series or shunt wound         | Completely enclosed           |                   |   |
| Unidirectional or reversible  | Adaptable for any mounting    |                   |   |
| High starting torque          | Laminated field poles         |                   |   |
| Low starting current          | Stainless steel shaft         |                   |   |
| Low RF interference           | Two precision ball bearings   |                   |   |
| Armature and field windings   | Mica insulated commutator     |                   |   |
| Varnish impregnated and baked | Permanent end play adjustment |                   |   |

1600 FRAME MOTORS		Series	Shunt
Watts Output, Int.	(max.)	22	
Watts Output, Con.	(max.)		5
Torque at 8500 RPM	(in. oz.)	3	
Torque at 5800 RPM	(in. oz.)	4.5	1
Lock Torque	(in. oz.)	12	3
Volts Input	(min.)	5	5
Volts Input	(max.)	32	32
Shaft Diameter	(max.)	.250"	.250"
Temperature Rise		50°C.	40°C.
Weight		12 oz.	12 oz.

**EICOR INC.** 1501 W. Congress St., Chicago, U.S.A.  
DYNAMOTORS • D. C. MOTORS • POWER PLANTS • CONVERTERS  
Export: Ad Auriema, 89 Broad St., New York, U. S. A. Cable: Auriema, New York



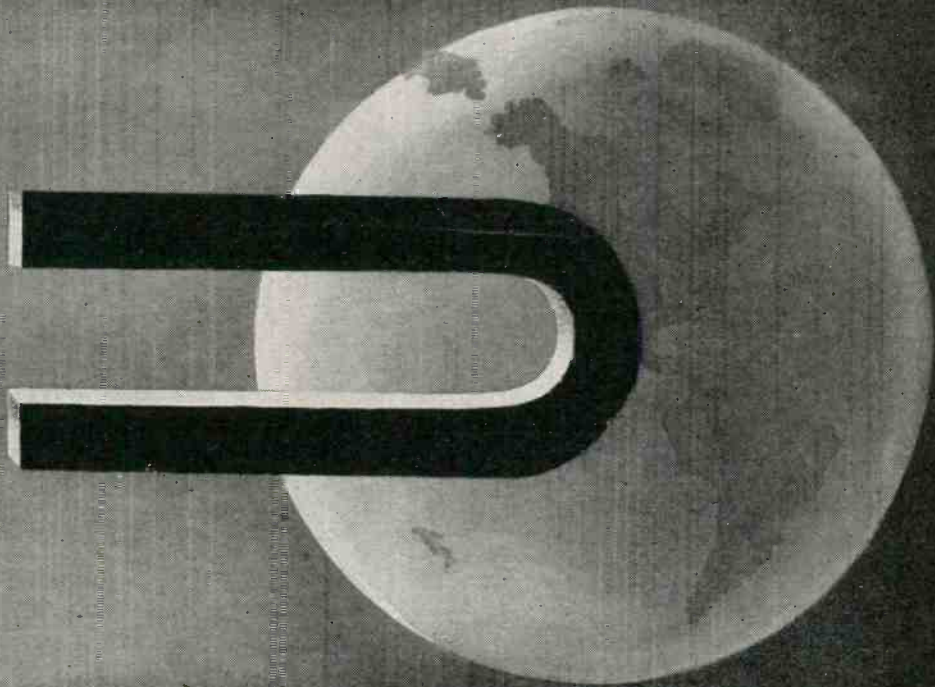
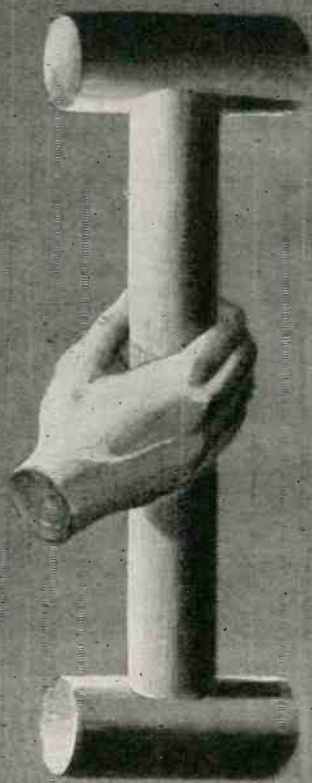

## DEFIES THE EARTH'S FIELD

SEARCH FOR induced or residual magnetism in aircraft or ships, magnetic fields in cargos, the location of hidden pipes, conduits, etc., is greatly facilitated by the Waugh Gradientometer.

This instrument is so designed that the earth's field is cancelled out and, in consequence, other magnetic fields are immediately indicated and easily located.

The Gradientometer needs neither leveling nor adjustment for measuring the change in strength, or gradient of magnetic fields. The snap of a switch converts it to a magnetometer for measuring the strength of magnetic fields.

Write for descriptive bulletin.

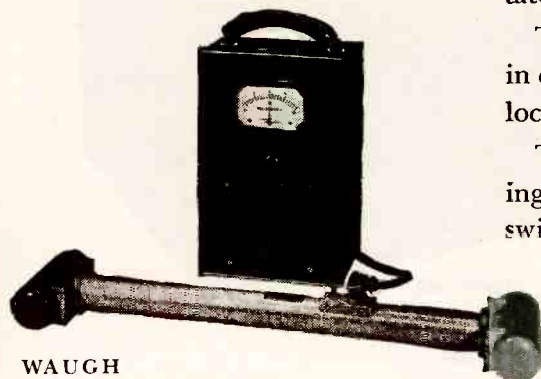

**WAUGH  
GRADIENTOMETER**

*Particularly designed for rapid magnetic inspection of aircraft or other structures to locate the source of local magnetic fields. Pick-up unit consists of two identical elements so positioned as to cancel out the earth's field. For this reason the instrument does not require leveling or orientation. Operates on 110 V. 60 cycle A.C.*



Write for Rental List and Service Manual on Business Letterhead.

**WAUGH**  
*Laboratories*

# REGULATED POWER SUPPLIES

**Excellent Regulation – Line Stability – Low Hum Level**

## **OUTPUT VOLTAGE**

Variable from 1.0 to 1.5 Volts DC.

## **OUTPUT CURRENT – 500 MA Max**

This model suitable for use in place of A Batteries where a source of AC power is available



Model 42A

---

**OUTPUT VOLTAGE** – Continuously variable from 0-300 Volts DC.

## **OUTPUT CURRENT – 250 MA Max**

General purpose supply which will deliver well-regulated DC at any voltage from 0-300.

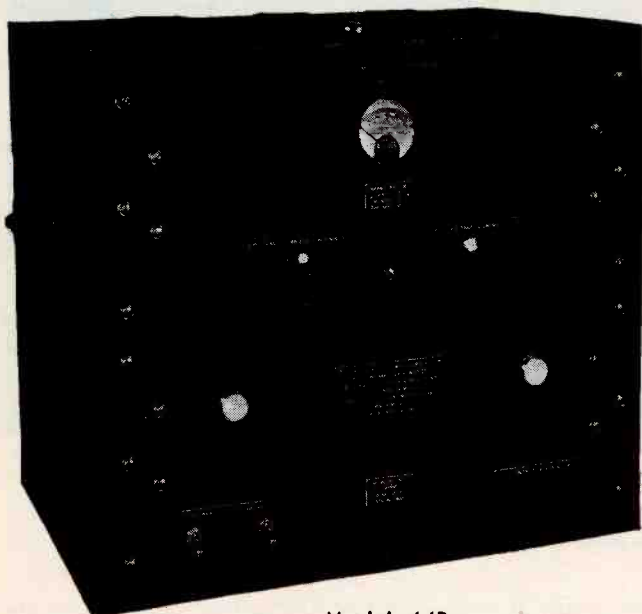

Model 44B

---

**OUTPUT VOLTAGE** – Continuously variable from 0-300 Volts DC

## **OUTPUT CURRENT – 100 MA Max**

Same characteristics as Model 44B except for lower current rating



Model 44

---

**Other units can be designed to specifications.**

---

**Inquiries are invited, both on power supplies and on our electronic consulting service.**

**DISTRIBUTED BY**  
**RADIO-TELEVISION INSTITUTE, INC.**  
**OF NEW YORK**  
480 LEXINGTON AVENUE      PLaza 3-4585      NEW YORK 17, N. Y.



**THE NOW FAMOUS SKYWAY "T" torque wrench** — tested and used by the Army Air Forces. An absolute torque limiting action incorporating a ratcheting shaft for production speed use. Range in two models, 0-25 inch pounds and 25-90 inch pounds.

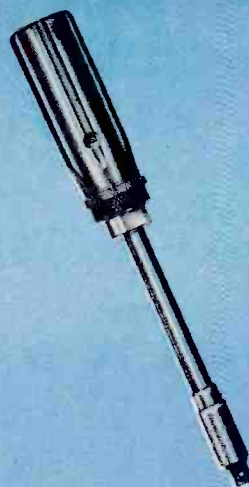

**THE TORQUE-TITE**, featuring torque calibrations in INCH OUNCES for use on small screw, nut and bolt fasteners. Again, torque limiting to insure positive tightening. Range: 0-10 Inch pounds.

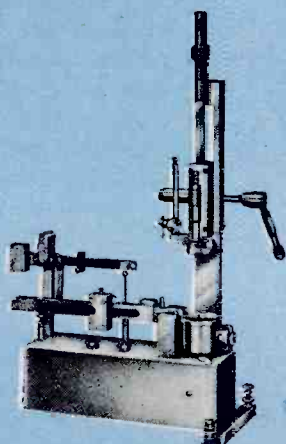

**"SPRING TESTER.** For production as well as laboratory tests". Fast and accurate indicating minimum and maximum spring values with one setting. Flash of green or red light indicators give an instant signal of these values. Sensitive and accurate within less than 250 milligrams.

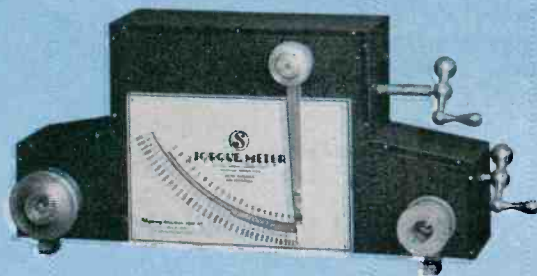

**THE STANDARD TORQUE METER** approved by our Army Air Forces and the Navy for use in accurately checking, or calibrating any type torque wrench. Models provided for any desired range of calibrations.

**Now AVAILABLE**  
 Complete engineering data and catalogs.  
 Discover production saving in time and  
 money by tooling with Skyway.  
 Write: Dept. E-7,

*Skyway*

**PRECISION TOOL COMPANY**  
 3217 Casitas Ave., Los Angeles 26, Calif.

REPRESENTATIVES: SEATTLE • CHICAGO • DETROIT • NEW YORK • BALTIMORE • PHILADELPHIA • INDIANAPOLIS

# SKILL

## To Meet Your Specifications

**PERFORMANCE** is the real measure of success in winning the war, just as it will be in the post-war world. New and better ideas—production economies—speed—all depend upon inherent **skill and high precision** . . . For many years our flexible organization has taken pride in doing a good job for purchasers of small motors. And we can help in creating and designing, when such service is needed. Please make a note of Alliance and get in touch with us.

### ALLIANCE DYNAMOTORS

Built with greatest precision and "know how" for **low ripple—high efficiency—low drain and a minimum of commutation transients**. High production here retains to the highest degree all the "criticals" which are so important in airborne power sources.

### ALLIANCE D. C. MOTORS

Incorporate precision tolerances throughout. Light weight—high efficiency—compactness. An achievement in small size and in power-to-weight ratio. Careful attention has been given to distribution of losses as well as their reduction to a minimum.



*Remember Alliance!*  
—YOUR ALLY IN WAR AS IN PEACE

**A**  
**ALLIANCE**  
**MANUFACTURING CO.**  
**A L L I A N C E . O H I O**

trons, the shield may consist of 10 to 20 cm of a hydrogenic material such as paraffin, for slowing down the neutrons, followed by a layer of cadmium or other substance as described above. Such a thickness of paraffin will slow down practically all the neutrons to an energy suitable for their capture by a cadmium shield. The detectors may be Geiger-Muller counters, or ionization chambers, and may be connected to suitable amplifiers to actuate indicating or recording instruments at the surface.

### Gamma-ray Detector

Since the number of gamma rays scattered per unit volume will depend on certain physical properties such as density and atomic number of the substances making up the formation, by measuring the number of such gamma rays scattered back to the detector we can obtain valuable information concerning the nature of the formation adjacent to the instrument. Thus, as the device is moved along the bore hole from point to point, changes will be noted in the intensity of the gamma rays scattered back to the detector and these changes may be correlated with the types of formations through which the bore hole has been drilled. A continuous survey may be made of a bore hole and, since the gamma rays are little influenced by the presence of iron or steel in the hole, the device can be used with success in the logging of holes containing casing or drill pipe.

### Neutron

The neutron detector is included to pick up those neutrons which are scattered and returned to the instrument in a manner similar to that in which the gamma ray detector operates. With this arrangement, additional information may be obtained such as the presence or absence of hydrogenic substances in the structure of the formations. This is particularly true if the detector is capable of differentiating between fast and slow neutrons, thus detecting those which have been slowed down by collision with hydrogen nuclei. Such a detector may be a boron-trifluoride ionization chamber.

A modification of the unit which



*Buy Bonds*  
SPEED VICTORY!

## SNIP IT, SEAL IT, SHIP IT!

*in Traco "All-Size" Bags*

**Tubular Form—1000 Foot Reels**

Make quickly in your own plant TITE-SEAL Cellophane Bags of any size that seal out dust, air, water and moisture-vapor. They protect military supplies from damage in transport or storage.

Acceptable for Methods I and IA, type III packaging . . . available in 3, 4, 6 and 8 inch widths under proper priority . . . 1000 feet to the reel. Saves stocking large quantities of special-sized bags. (Stock Bags also available in above widths.)

"All-Size" Containers and custom made bags can be furnished plain or printed in any widths or lengths desired on special orders of sufficient quantity.

Heavy foil-lined laminated bags or tubes meet every requirement of Methods I, IA and II Military Packaging. LOXTITE Partitions give crash protection to fuses, rations, and delicate or fragile items.

Reasonably prompt shipment can be made on government orders bearing end use. A card will place our technicians at your command.

T. M. Reg. & Patent applied for

# TRAVER CORPORATION

Dept. ET75 • 358-368 West Ontario Street • Chicago 10, Illinois



BOX PARTITION DIVISION  
404 N. Sacramento Blvd., Chicago 12

# LOOK to BEST

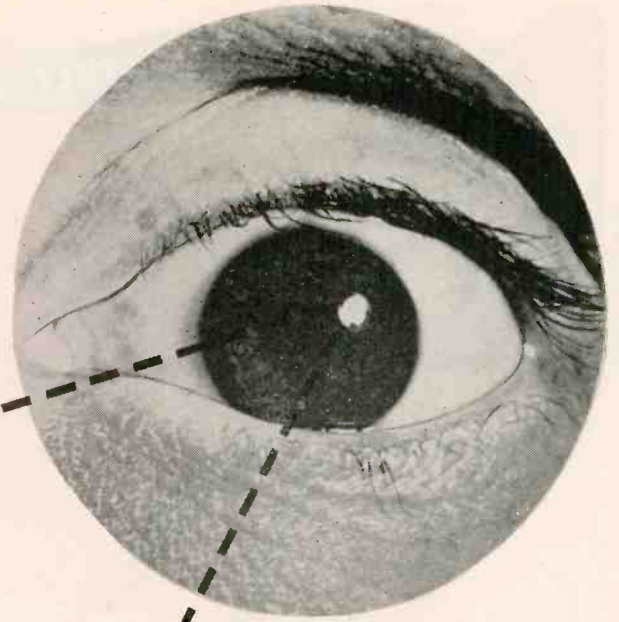

Thirty new BEST speakers, incorporating every advance in speaker design, achieve higher efficiency at lower cost through the use of ALNICO 5 permanent magnets.

## for quantity deliveries of "controlled performance" LOUD SPEAKERS

A dependable source of supply for quality loud speakers need not be a problem. We at BEST are aware of the continuing urgency of keeping your production lines rolling. Our facilities are complete for the manufacture of precision coils, transformers and loud speakers, which have flowed from this plant in increasing quantity for almost a quarter of a century. Whether your problem be one of design or quantity production, rely on BEST to deliver the goods on time!

We invite your inquiry

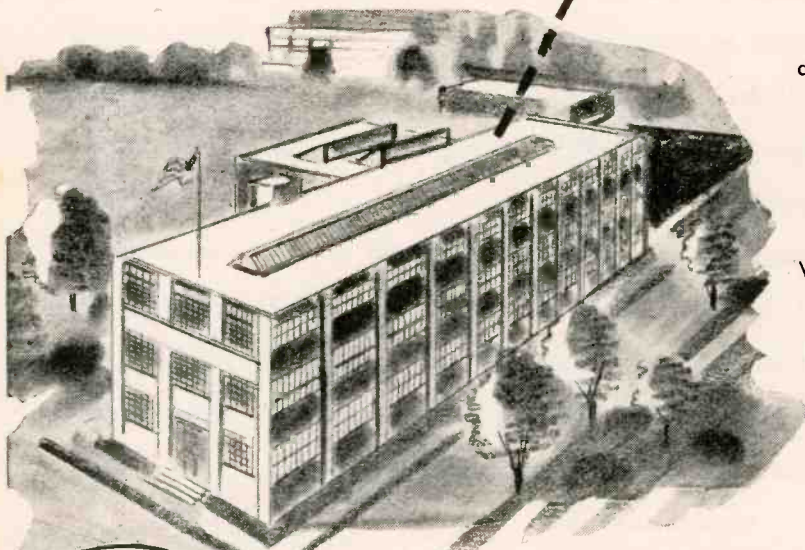

**BEST**

SINCE 1922

**BEST MANUFACTURING CO., INC.**  
*Electronic and Sound Reproducing Equipment*  
1200 GROVE STREET • IRVINGTON 11, N. J.

# 10

# POINTS OF *Superiority*

10. THICK, ROUNDED EDGE, ALUMINUM PLATES FOR MECHANICAL STABILITY AND INCREASED VOLTAGE BREAKDOWN.

1. REMOVABLE BRACKETS FOR MOUNTING COILS ON TOP OR MOUNTING CONDENSER INVERTED

2. STAINLESS STEEL GROUND STOCK, SHAFTS

9. STATORS MOUNTED ON TOP SIDE FOR LOW STRAY CAPACITY

8. LOW RESISTANCE ROTOR OR CONTACTS OF LONG LIFE, PHOSPHOR BRONZE, SPRING MATERIAL

7. GRADE L4 STEATITE LOW LOSS INSULATION CORRECTLY PLACED FOR LONG LEAKAGE PATH AND SMALL DIELECTRIC LOSS

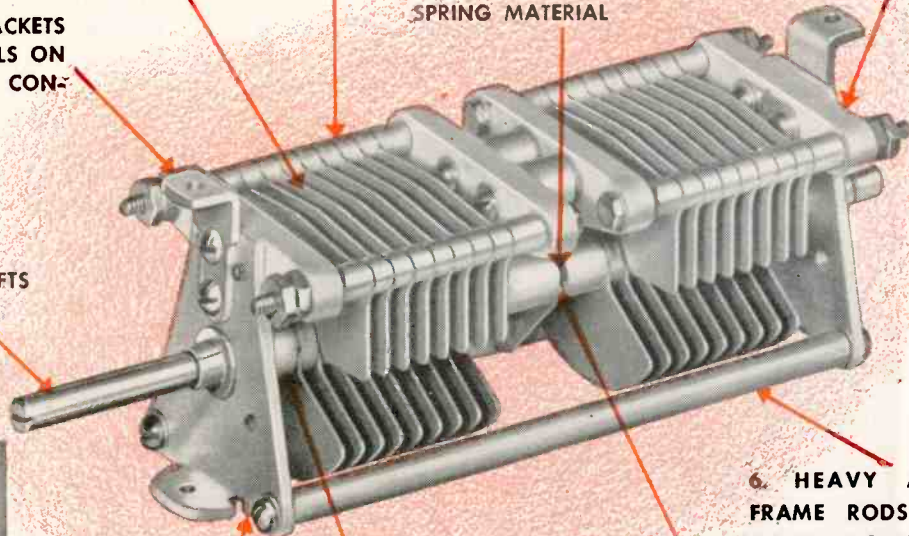

3. HEAVY END PLATES FOR STRENGTH

CATALOG NO. 100FD20

6. HEAVY ALUMINUM FRAME RODS FOR TORSIONAL RIGIDITY.

5. CENTER CONTACT BETWEEN SECTIONS FOR SHORT R. F. LEADS

4. PERFECTLY ALIGNED ROTOR SHAFTS FOR CALIBRATION ACCURACY

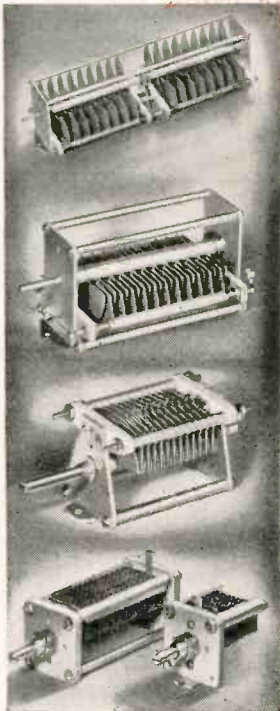

C - Plate spacing	.125" - .500"
Maximum frame dimensions	5½" x 5-13 32"
D - Plate spacing	.080" - .250"
Maximum frame dimensions	4½" x 4"
E - Plate spacing	.045" - .125"
Maximum frame dimensions	2½" x 2-19 32"
H - Plate spacing	.030" & .080"
Maximum frame dimensions	1½" & 1-9 16"

Type "F" single and dual condensers are stocked with plate spacings of .045 to .075" in 19 different models. Maximum capacity range is from 34 mmf. to 255 mmf. and the ratios of maximum to minimum run from 7:1 to 15:1. Maximum frame dimensions 2-1 16" by 2".



# JOHNSON

*a famous name in Radio*

E. F. JOHNSON COMPANY • WASECA • MINNESOTA

# NEW ANGLE CORRECTION CRYSTAL EDGING MACHINE

**CORRECTS "X" AXIS IN MINUTES OF A DEGREE TO MEET SIGNAL CORPS SPECIFICATIONS**

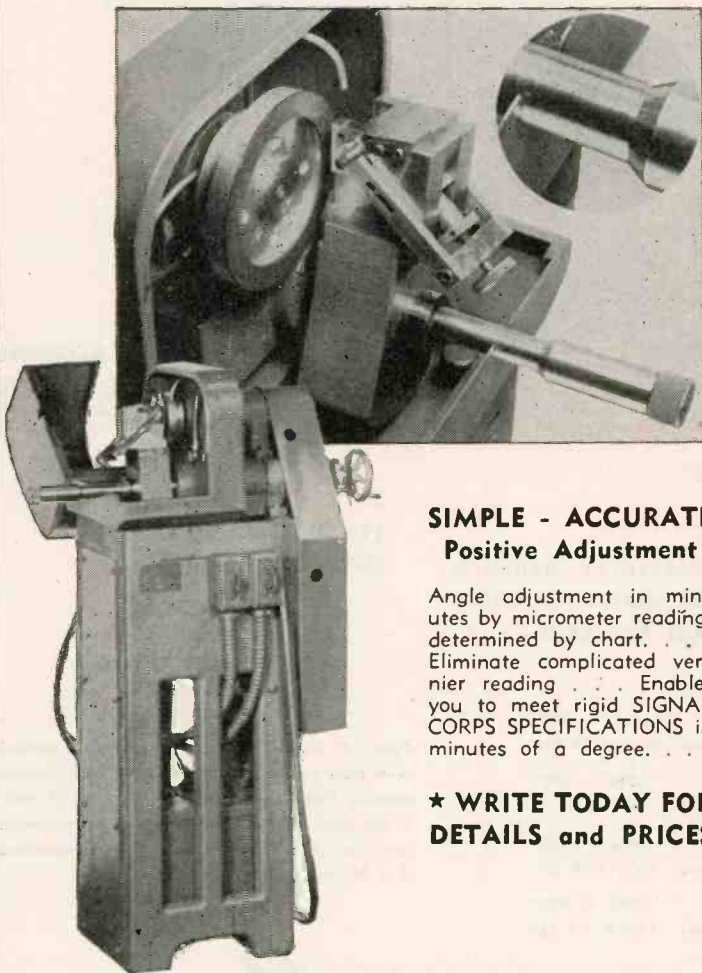

### **SIMPLE - ACCURATE Positive Adjustment**

Angle adjustment in minutes by micrometer reading, determined by chart. . . . Eliminate complicated vernier reading . . . Enables you to meet rigid SIGNAL CORPS SPECIFICATIONS in minutes of a degree. . . .

**★ WRITE TODAY FOR  
DETAILS and PRICES**

## **VOLKEL BROS. MACHINE WORKS**

1943 West Manchester - Los Angeles 44, Calif.

*Designers and Manufacturers of*  
**SPECIAL DEVICES & EQUIPMENT**

employs three detectors is also shown in the accompanying illustration. This arrangement is designed for detecting the change in penetrating power or hardness of the gamma radiation caused by scattering in the formation. Two gamma-ray detectors are employed, one being well shielded to provide selective absorption as a function of wavelength of the radiation while the other is unshielded. The shield around the detector decreases the intensity of the less penetrating gamma radiation and permits the detector to record principally the radiation which has been least affected by the scattering process. Comparison of the intensity registered by the two detectors provides information regarding the scattering processes and thus of the type of formation doing the scattering.

### **Five Radio-Frequency Bridge Circuits**

THE FOLLOWING SERIES of radio-frequency bridges have been developed by the British Broadcasting Corporation during the past ten years and a more detailed description of them was given by H. L. Kirke, head of the research department, in delivering the chairman's address for 1945 of the IEE radio section. They are all types that have been well proved by long usage in the field and laboratory.

A short-wave admittance bridge is shown in the schematic of Fig. 1. Reactance balance is obtained by

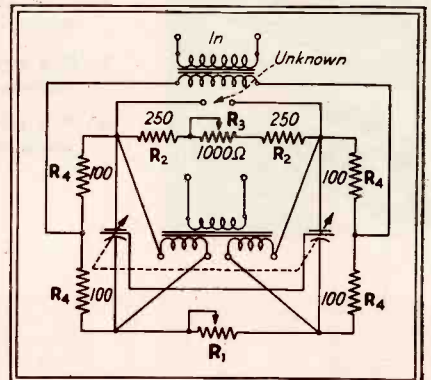
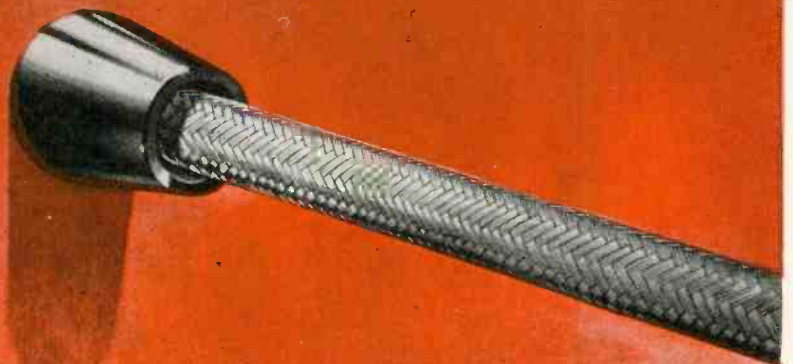

Fig. 1—Short-wave admittance bridge for field use. Resistor  $R_1$  is the standard resistor and resistors  $R_2$  and  $R_3$  are used to balance the maximum value of  $R_1$ . Resistors  $R_4$  are the ratio arms of the bridge



# PERHAPS YOU WOULDN'T THINK OF USING *Plastics* HERE



A product designer did . . . producing a new and improved grommet design using a special flame-resistant Lumarith\* CA formulation.



Des-Grommet components and assembled grommet

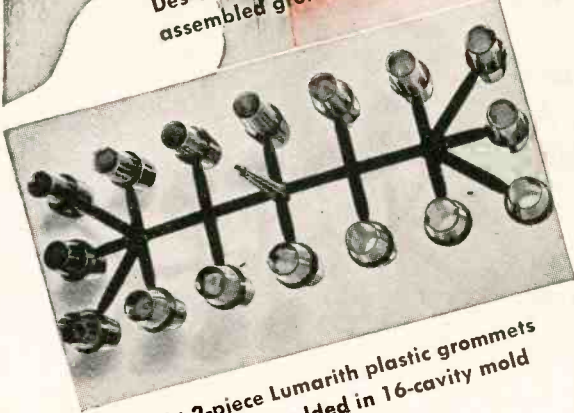

Eight 2-piece Lumarith plastic grommets are injection molded in 16-cavity mold

THERE ARE sound reasons why Jan De Swart of Victory Manufacturing Company turned to Lumarith plastics when he developed the "Des-Grommet" for use on U. S. naval vessels. In abrasion tests using braided metal cable the Lumarith grommet showed less deterioration than did grommets made of lead, and caused far less wear to the braided cable than steel grommets did.

By taking full advantages of the physical characteristics of Lumarith, the Des-Grommet is designed to be self-locking, capable of blind installation (from one side of partition), and adjustable to as many as five different wall thicknesses. A special non-burning formulation of Lumarith CA (cellulose acetate) was used to meet Maritime Commission requirements for fireproof material.

The use of Lumarith in place of metal reduces production time and manufacturing costs. Grommets are injection molded in a matter of seconds—using multiple cavity molds. Finishing and polishing operations are reduced to a minimum. No machining, plating or enamelling is required.

The development of the Des-Grommet is a good example of the right approach to plastics. It is the type of project that the technical staff of Celanese is prepared to help you accomplish with your product. Your inquiries are invited. Celanese Plastics Corporation, a division of Celanese Corporation of America, 180 Madison Avenue, New York 16, New York.

# LUMARITH\*

*A Celanese\* Plastic*

\*Reg. U. S. Pat. Off.

# Sorensen Regulators



## FOR A TOUGH JOB

Where the resonate type Voltage regulator can't meet the specs—when you need a regulator not affected by frequency variations—where the output wave form must not be altered by the regulator—call for Sorensen.

**For Aircraft applications**—400 cycle. Frequency Variation  $\pm$  10% Input Voltage 90–140 V. A. C. Output—115 V. A. C.  $\pm$   $\frac{3}{4}$  of 1%; 500 Watts. Weight 13 pounds. Meets A. N. Specifications.

50-70 Cycles Input 90 – 140 V. A. C. Output 115 V  $\pm$   $\frac{3}{4}$  of 1%; 1200-1750 Watts. Weight 60 pounds.

All transformer components are hermetically sealed and tropicalized throughout.

# SORENSEN & COMPANY

AIRBORNE ELECTRONICS

»

»

»

STAMFORD, CONN.

R. P. M.

# An Achievement in Motor Engineering

7000

6000

5000

4000

3000

2000

1000

0

400

600

800

1000

1200

1400

1600

1800

*Graph shows . . .*

OUR J-31C MOTOR DRIVING A  
No. 2 BLOWER, WHICH COMPRISES  
OUR MODEL J-52 BLOWER UNIT



Line Frequency — cycles per second

**400 to 1800 cycles**  
**Variable Frequency Induction Motor**

The development of this variable frequency motor represents a real advance in the art of motor engineering. It is typical of the abilities of Eastern Air Devices where unusual research, engineering, tool making and production skills combine to build special products for which no specifications exist.

We invite engineering problem inquiries.

**EASTERN AIR DEVICES, INC.**  
585 Dean Street • Brooklyn 17, N. Y.

An Affiliate of The Fred Goetz Co., Inc., Est. 1893



**MODEL  
J-31C**



This motor operates over entire frequency range of 400 to 1800 cycles with 115 volt supply and 0.3 mfd. condenser. When driving Blowers or Fans will deliver 17 to 20 C.F.M.

**Dimensions:**

Overall Diameter  $1\frac{15}{16}$ "

Overall Length  $2\frac{29}{32}$ "

Weight . . . . . 16 oz.

MANUFACTURERS OF CONTROL DEVICES AND COMPONENTS FOR ELECTRICAL, ELECTRONIC AND MECHANICAL APPLICATIONS

*This may be your new*  
**ELECTRICAL TESTING  
 DEPARTMENT**



**T**HE section of the testing department shown is one of the most important divisions at Unionair, now producing electrical assemblies solely for wartime use.

The units shown have been approved by the Inspection Department and are being subjected to sustained electrical tests as their final test prior to shipment.

This department may be yours, soon we hope, when we can put its knowledge to work on making electrical assemblies to your specifications.

Our new booklet titled, "Electrical Assemblies made to Customers' Specifications" is available on request. Write to: Union Aircraft Products Corp., Dept. E, 245 East 23rd Street, New York 10, N. Y.



**UNIONAIR**

*Electrical Assemblies—Hydraulic Fittings  
 Conduit Fittings—Junction Boxes*

UNION AIRCRAFT PRODUCTS CORP., NEW YORK

the ganged differential capacitors  $C$  and resistance balance by a verifiable carbon resistor. Comparison of the unknown quantity and the internal standard is by means of a three-winding, dust-cored transformer. Two of the windings are used differentially to produce a null balance; the third is an output winding for the detector. This bridge is particularly valuable in the field, due to the rapidity with which it can be used, although the accuracy is not of the highest order.

A medium and long-wave admittance bridge is given in Fig. 2. This bridge is somewhat similar to that shown in Fig. 1 but the resistance ratio arms are replaced by

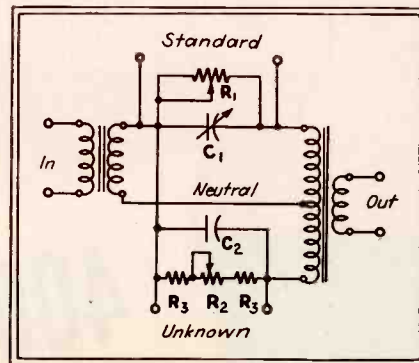

Fig. 2—Medium and long-wave admittance bridge. Capacitor  $C_1$  is the standard and  $C_2$  is a fixed capacitor which is switched in for inductance measurement

the transformer windings used previously for the same purpose. It uses standards consisting of a variable capacitor and a variable resistor in parallel. Normally it measures unbalanced impedances but can handle balanced types when converted to the type of bridge shown in Fig. 1. The change is carried out by means of a switch. Internal standards are provided but external ones can be used.

*Multi-Ratio Bridge*

A medium and long-wave multi-ratio admittance bridge is shown in Fig. 3. This form of bridge has been designed for use in the frequency range from 15 kc to 2 Mc and the various ratios are obtained by tapped transformers. As before, a resistor and a capacitor, effec-



## It's Wire with a **VOICE**

*Listen! That's your own voice you hear. Or a radio program caught and recorded straight from the air. Or maybe a program produced by your own youngsters.*

*It all comes from the thin wire that runs through the Lear Wire Recorder—a wire magnetically impressed with sound through an entirely new method of recording brought to its present high state in Lear laboratories.*

*Wire recording will be a part of Lear Home Radios. But home entertainment is only one of*

*countless sensational applications. Think of a dictating machine with no records to break or keep shaved—and business conferences, meetings, telephone conversations kept precisely and permanently for future reference.*

*No one has yet begun to explore the full realm of possibilities that lie in Lear Wire Recording. But to give you a glimpse of how it works and a few of the ways it can be used, Lear has prepared a free booklet of questions and answers. Would you like one? Just drop us a line—or mail the coupon below.*



# LEAR RADIO

Grand Rapids 2, Michigan

Home Radio Sales: 230 E. Ohio St., Chicago 11, Illinois

LEAR, Incorporated  
Home Radio Sales Division  
230 E. Ohio St.,  
Chicago 11, Ill.

Gentlemen:

I am interested in the development of wire recording and the ways in which it may be used. Please send me your free booklet.

Name \_\_\_\_\_

Address \_\_\_\_\_

City \_\_\_\_\_ State \_\_\_\_\_

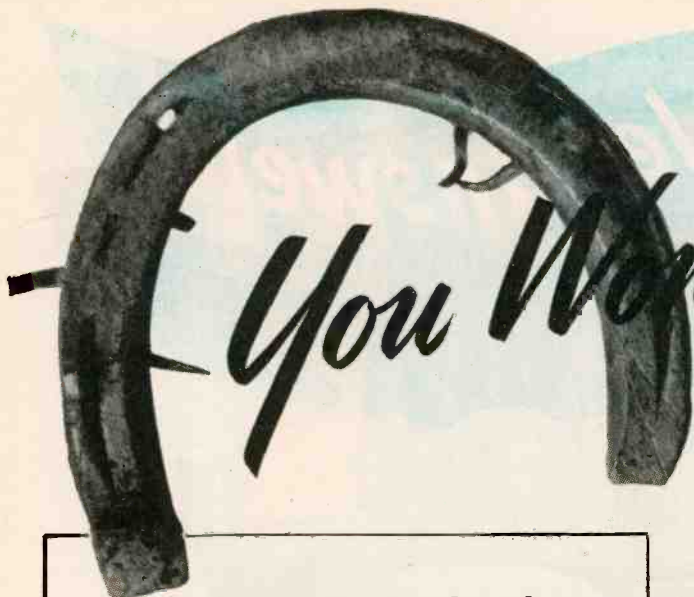

# You Won't Need This

If Your Product is  
**WIRE-PLANNED and WIRED RIGHT**

**Permanently Insulated**  
**Rockbestos, Wires, Cables and**  
**Cords Assure Long-lasting,**  
**Dependable Performance**

#### SHIELDED ROCKBESTOS FIREWALL RADIO HOOKUP WIRE

1000 volt in sizes No. 22 to 4 AWG and 3000 volt in sizes No. 16 to 12 AWG with stranded tinned copper conductors insulated with synthetic tapes and felted asbestos, covered with lacquer-finished, color coded glass braid and shielded with a tinned copper braid. Heat, flame and moisture resistant, light weight, small diameter construction; operating temperature range 125°C. to minus 50°C. Also available without shielding and in twisted pair and multi-conductor constructions.



#### ROCKBESTOS FIREWALL MULTI-CONDUCTOR INSTRUMENT CABLE

This unusually small diameter, light-weight, high-dielectric No. 26 AWG three-conductor cable was designed for an electronic device in which three No. 22 AWG single conductor aircraft circuit wires previously used had proved too bulky. It is made to a nominal diameter of .125" (smaller than a No. 14 AWG single conductor 1000 volt Rockbestos Firewall Radio Hookup Wire). Also in 4 and 5 conductor constructions, in sizes No. 26 to 20 AWG.

#### ROCKBESTOS ASBESTOS INSULATED LEAD WIRE

Sizes No. 22 to 4 AWG solid or stranded copper, monel or nickel conductors insulated with .031" or .040" of impregnated felted asbestos in black, white or colors. Heatproof and flame-resistant, this lead wire will not bake brittle and crack under vibration, won't rot, swell or flow when in contact with oil or grease, and has ample moisture resistance for most applications. For high dielectric strength and added moisture resistance specify Type CA Lead Wire with synthetic tape next to the conductor.

#### ROCKBESTOS ASBESTOS INSULATED MAGNET WIRE

Round, square and rectangular asbestos insulated conductors finished to meet varying winding conditions and coil treatment requirements. Designed for Class B windings and also suitable for use as insulated bus wire where high-dielectric strength is not required. The insulation is non-checking and is unaffected by heat or aging.

*A few of the 125 different wires, cables and cords designed for severe operating or unusual conditions by Rockbestos.*

#### HOW DO YOUR WIRE SPECIFICATIONS COMPARE WITH YOUR DESIGN AND OPERATING CHARACTERISTICS?

FOR THIS IN YOUR PRODUCT	SPECIFY THIS IN YOUR WIRE
FIRE HAZARD <input type="checkbox"/>	RESISTANCE TO FLAME <input type="checkbox"/>
VIBRATION <input type="checkbox"/>	PERMANENT FLEXIBILITY <input type="checkbox"/>
OPERATING VOLTAGE <input type="checkbox"/>	VOLTAGE RATING <input type="checkbox"/>
POSSIBLE OPERATION UNDER OVERLOADS <input type="checkbox"/>	HIGH CURRENT CARRYING CAPACITY <input type="checkbox"/>
EXCESS VOLTAGE DROP <input type="checkbox"/>	ADEQUATE CONDUCTOR SIZE <input type="checkbox"/>
WIRE TERMINATIONS <input type="checkbox"/>	FREE STRIPPING AND SIZE <input type="checkbox"/>
CONDUIT AND BUSHINGS <input type="checkbox"/>	MAXIMUM DIAMETERS <input type="checkbox"/>
EXPOSURE TO MOISTURE <input type="checkbox"/>	MOISTURE RESISTANCE <input type="checkbox"/>
OIL, GREASE AND FUMES <input type="checkbox"/>	RESISTANCE TO ROTTING <input type="checkbox"/>
OPERATING AND AMBIENT TEMPERATURE RANGES <input type="checkbox"/>	RESISTANCE TO CONDUCTOR AND EXTERNAL HEATING <input type="checkbox"/>

Is that job you're working on apt to be used where ambient temperatures climb too high for wire comfort? Is it going to develop considerable heat in operation? Are conduit bends so snug that wire may be abraded when installed? Should thought be given to wire-fire hazards? And how about overloads . . . etc. . . . etc.?

Check and *double-check* these trouble sources . . . and *everything else* you can think of that might open the way for wire-failures that may cause your smooth working models to break down under actual service conditions . . . then *specify* wire that gives you an *ample safety margin* of resistance to heat, moisture, oil, grease, corrosive fumes and flame.

For help in your wire-planning call in our field engineers for recommendations from our line of 125 different *permanently insulated* standard constructions . . . and if your wiring problem calls for something special Rockbestos Research will be glad to go to work on it. Just give us the details or ask us to call. Address the nearest branch office or:



**Rockbestos Products Corporation**

425 Nicoll St., New Haven 4, Conn.

**ROCKBESTOS RESEARCH**

**Solves Difficult Wiring Problems**

NEW YORK BUFFALO CLEVELAND CHICAGO PITTSBURGH ST. LOUIS LOS ANGELES SAN FRANCISCO SEATTLE PORTLAND, ORE.

**INVEST IN WAR BONDS • MAKE EVERY PAYDAY A LAY-AWAY DAY**

# Two simpler answers\* TO ANY BUSHING PROBLEM

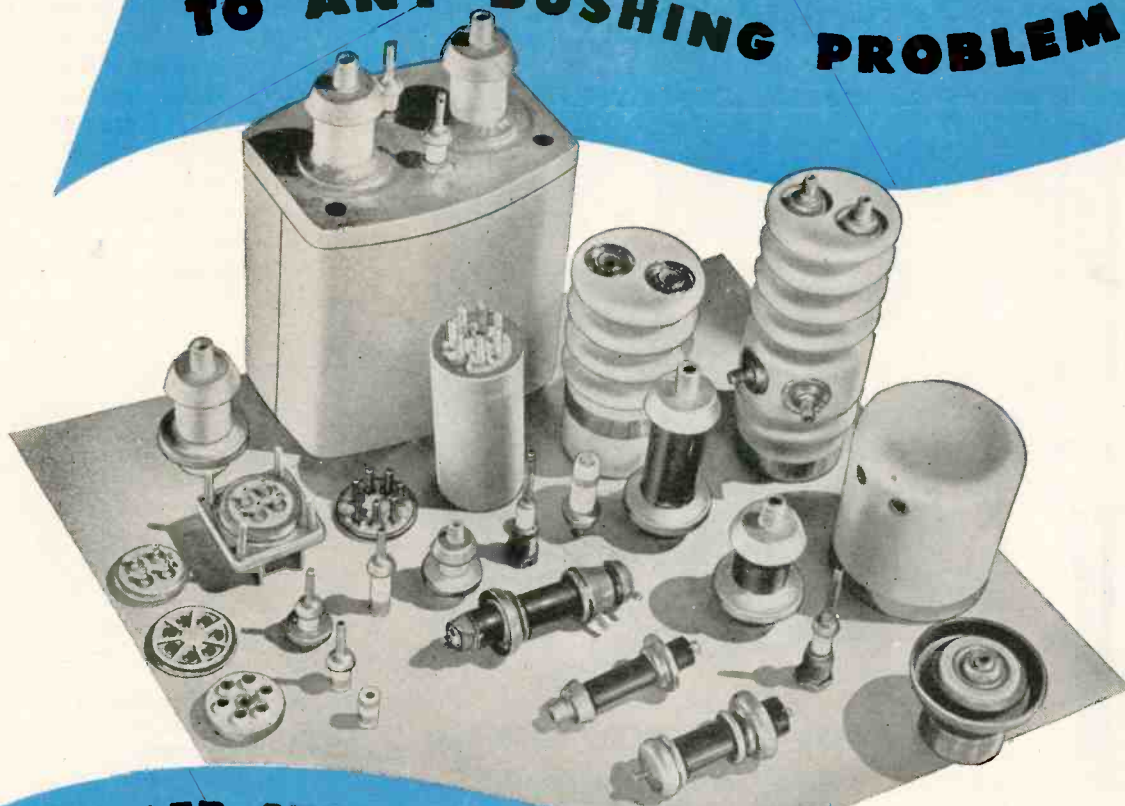

## \*SOLDER-SEAL AND PRESTITE

Solder-Seal bushings of Zircon Prestite provide a better and simpler answer to any problem of obtaining a hermetic seal between the bushing and the casing of communications equipment.

Solder-Sealing joins Zircon Prestite directly to the metal stud to form a single unit that can, in turn, be directly soldered to the case. Perfect hermetic sealing is the result . . . sealing out damaging dirt, moisture and corrosive atmospheres . . . eliminating oil leakage . . . permitting operation under permanent pressure to stabilize dielectric strength.

This new and improved Westinghouse porcelain . . . Zircon Prestite . . . is mechanically strong and impervious to moisture. It has a low-loss factor and high resistance to heat shock (see table). Millions of Solder-Seal and Prestite bushing applications are in war service today . . . proving a simpler, quicker, more dependable answer to bushing problems as a result of 15 years of Westinghouse experience and engineering.

For complete information on Solder-Seal and Zircon Prestite, write to Westinghouse Electric Corporation, P. O. Box 868, Pittsburgh 30, Pennsylvania. J-05155

**Westinghouse**  
PLANTS IN 25 CITIES . . . OFFICES EVERYWHERE



**COMMUNICATIONS  
EQUIPMENT**

ELECTRONICS — July 1945



CHARACTERISTICS OF ZIRCON PRESTITE

Property	*Zircon Prestite	High-Tension Porcelain
Specific Gravity . . . . .	3.68	2.4
Water Absorption, in % . . . . .	0.00	0.00
Dye Penetration . . . . .	None	None
**Linear Coeff of Thermal Expansion (20 to 7000 deg C) per deg C . . . . .	$4.9 \times 10^{-6}$	$5.3 \times 10^{-6}$
Tensile Strength, lb per sq in . . . . .	12,000	5,000
Compressive Strength, lb per sq in . . . . .	90,000	48,000
Transverse Strength, lb per sq in . . . . .	25,000	11,000
Impact Resistance (modified Charpy method) in gm per sq cm . . . . .	17,800	6,000

\*Approved as L-4 material by the Army-Navy Electronics Standards Agency.

\*\*This characteristic gives Zircon Prestite its remarkable thermal shock properties and warrants comparison with other low-loss, high-frequency ceramic materials.

# COMCO CRAFTSMANSHIP MEANS

## Customized

### RADIO AND ELECTRONIC EQUIPMENT

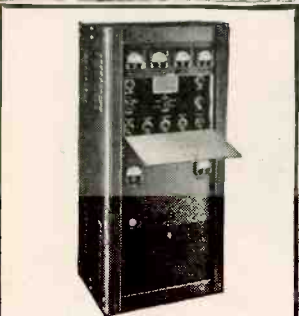
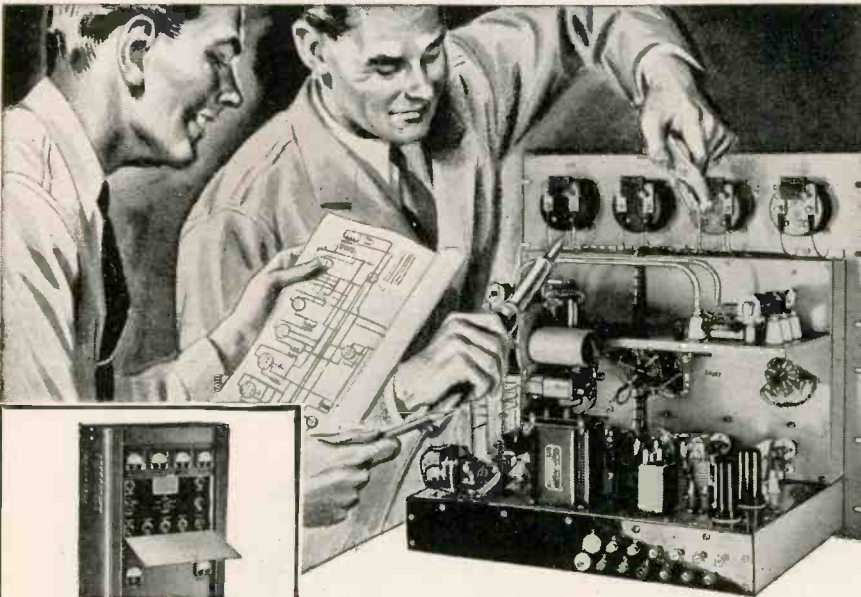

TRANSMITTERS—Fixed Station 2—160 Mc. Low & Medium Frequency and VHF.



RECEIVERS—Fixed Tuned, Rack Type 2—160 Mc. Low & Medium Frequency and VHF.



TRANSMITTER-RECEIVERS—Mobile and Fixed Station Types 2.5—8 Mc.

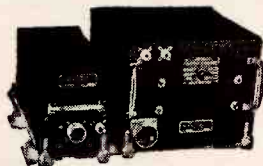

TRANSMITTERS and RECEIVERS—VHF Mobile and Fixed Station units 30—160 Mc. FM and AM Models.

**Needed elsewhere today ...  
... ready for tomorrow**

It was only natural that Comco should be called early to serve in America's war effort. Our craftsmen were long experienced. Our facilities were geared to quality standards.

And it is only proper that our commercial production should be rigidly restricted now. We are building many types of radio and electronic equipment urgently needed by our fighting forces.

When victory is won, and our war-time commitments are fulfilled, Comco skills and equipment—our engineering know how—will again be devoted to making peace-time products for peace-loving America.

Imbued with the idea of "not how many, but how good" ... trained to *take time* to do things well ... Comco CUSTOMIZED equipment of Tomorrow promises even more dependability, even finer performance, a still higher level of dollar value.

WRITE! Just a note on your company letterhead outlining your exact requirements. We'll give you the benefit of our specialized experience. We can supply a wide variety of CUSTOMIZED equipment on priority NOW. We are accepting non-priority orders for post-war delivery.



MANUFACTURERS OF RADIO & ELECTRONIC EQUIPMENT

**COMMUNICATIONS COMPANY, Inc.**  
CORAL GABLES 34, FLORIDA

tively in parallel, form the standard but each can be connected to different transformer taps to provide independent resistance and reactance ratios.

To maintain exact voltage ratio and phase in the standards and unknown values, under different conditions of loading, the leakage reactance of the transformer is minimized by the use of a Mumetal strip wound as a toroid, and also by careful winding.

A radio receiver 2-gang capacitor of 7-250  $\mu\text{mf}$  is used for the standard. It is switched between

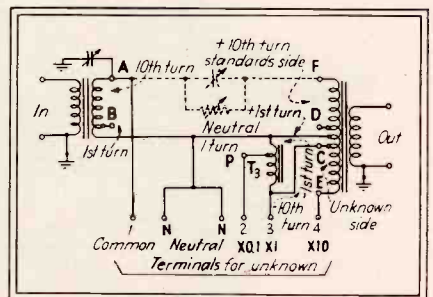

Fig. 3—Tapped transformers are used in this bridge circuit to provide several ranges

taps of the input transformer and taps on the standard side of the output transformer for capacitance measurements, and to one of the taps on the unknown side for inductance measurements.

For resistance balance, a 1000-ohm potential divider (Fig. 4) is connected across appropriate taps

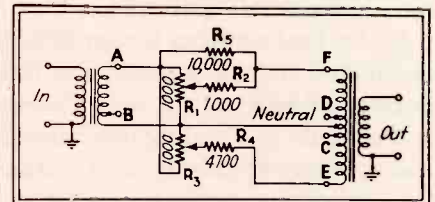

Fig. 4—Resistance balance is obtained by adding  $R_1$  and  $R_3$  to the circuit shown in Fig. 3

of the input transformer and a fixed resistor  $R_2$  from the slider is switched to either tap on the output transformer. The inductance of the potential divider is thus of less importance than if it were used as a variable resistor. The ranges of the bridge are:

Capacitance: 0.01  $\mu\text{mf}$  to 25,000  $\mu\text{mf}$ .

Inductance: Such as will reso-



*"Accentuate the Positive"*



WITH THIS  
**IRC**  
COAXIAL  
CONNECTOR

For positive, vibration-free contacts, here's a plug that daily is proving satisfactory in many UHF applications. Of Navy design, it is built to meet the rigid standards of both Service branches and can be depended upon for faultless operation where ease and rapidity of making and breaking electrical connections are important. Originally engineered to meet the severe requirements of warfare, it will readily find many uses in commercial fields.

All metal parts of this popular connector are heavily silver-plated. Contact parts are of specially tempered spring-brass and the plug is insulated with low-loss mica-filled bakelite.

The connector is designed to take Army-Navy cables Types RG-7/U, RG-8/U and RG-11/U. When ordering specify plug #50.393-1 (Navy Part Number CI-49195, U.S. Signal Corps Number PL-259A.)

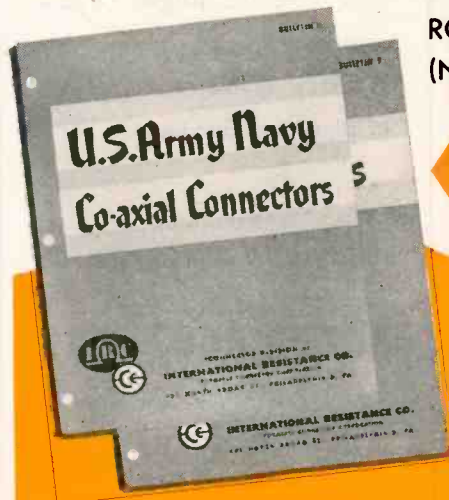

For dimensional drawings and information on this and other types of IRC coaxial connectors and receptacles, write for Bulletin #4.



CONNECTOR DIVISION OF  
**INTERNATIONAL RESISTANCE CO.**

401 N. BROAD ST. PHILADELPHIA 8, PA.

DEPT. G-1

*Attention please*

## MARINE SALVAGE COMPANIES AND DEEP SEA DIVERS

We are the exclusive suppliers to U. S. Navy of deep sea communicating equipment for divers, designed and manufactured by us.

The U. S. Navy has released this "Restricted" equipment to us for sale to commercial salvage companies and divers.

*Information on request.*

### GUIDED RADIO CORPORATION

161 Sixth Avenue

New York 13, New York

*Make Plans Now...  
for the coming . . .*

## PLASTIC ERA

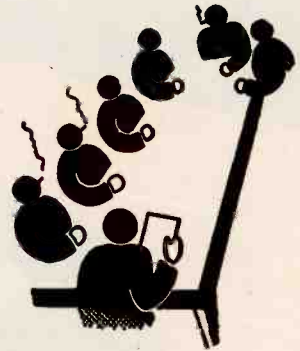

*Consult . . .*

## ROGAN

• Here at Rogan, seasoned engineers are ready and willing to assist you in determining your post-war *Plastic* requirements.

Whether your peacetime products are to include electronic equipment, electrical appliances, stoves or what have you, the Rogan Organization will gladly provide cost-free advice on all phases of plastic production.

*Send us*

*Your Specifications Today!*

## ROGAN BROTHERS

*Compression Molders and Branders  
of Plastics*

2003 So. Michigan Avenue  
Chicago, Illinois

## OPTICAL MIRRORS and REFLECTORS

FOR ELECTRONIC, OPTICAL  
AND SCIENTIFIC APPARATUS

WE specialize in the production of front or rear surface mirrors, made to your specifications. Closest optical and dimensional tolerances observed.

Because of their proven superiority, ZENITH mirrors are preferred by many leading manufacturers of precision equipment.

- EXCEPTIONAL REFLECTIVITY
- ALUMINUM, SILVER, GOLD, etc.
- OPAQUE OR SEMI-TRANSPARENT
- PERMANENT CHARACTERISTICS
- PROMPT SERVICE

*We invite your inquiry. Samples and quotations will be submitted promptly.*

## ZENITH OPTICAL LABORATORY

SPECIALISTS IN  
VACUUM DEPOSITION



123 WEST 64th STREET  
NEW YORK 23, N. Y.

## OKONITE "FIRSTS" FOR THE NAVY

- First to offer a corrosion-resistant lead alloy coating for copper conductors ("Okoloy")
- First to develop a method of assembling conductors to increase resistance against twisting ("Unilay")
- First to supply conductors insulated with a non-flammable synthetic dielectric ("Okoseal")
- First to protect conductors with flame-resistant glass fiber insulation ("Okoglass")
- First to manufacture the synthetic impervious sheath for protecting cables ("Okoseal")



OKOSEAL as wire insulation is moisture-tight, non-flammable, resistant to chemicals, oils, and ozone.

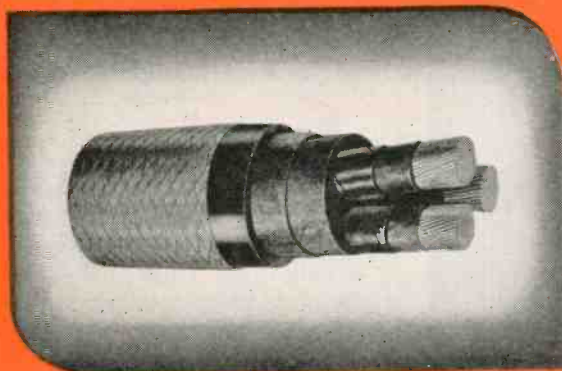

OKOSEAL as a flexible sheath, in addition to the above advantages, is light in weight and mechanically strong.

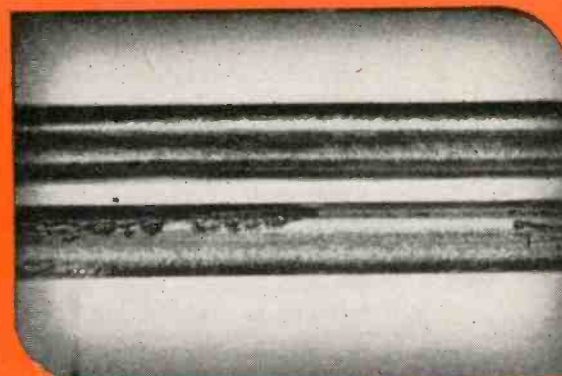

OKOLOY affords a corrosion-proof lead alloy conductor coating that outlasts tinning at least 2 to 1. Okoloy (top) is unaffected by immersion.

# they ALL benefit the ELECTRONICS industry

Meeting Navy demands has been more than a challenging experience to Okonite chemists and research engineers. It has helped to introduce better products of greater value to all industry. Among Okonite's pre-war developments in electric cable and insulated wire are many which have been improved and which have found their greatest usefulness in wartime. Some of them whose service advantages have commercial applications are listed and illustrated. Write for further information on any or all of them or for assistance on any specific problem involving the transmission or distribution of electrical power through insulated wires and cables. The Okonite Company, Passaic, New Jersey.



## OKONITE

insulated wires and cables

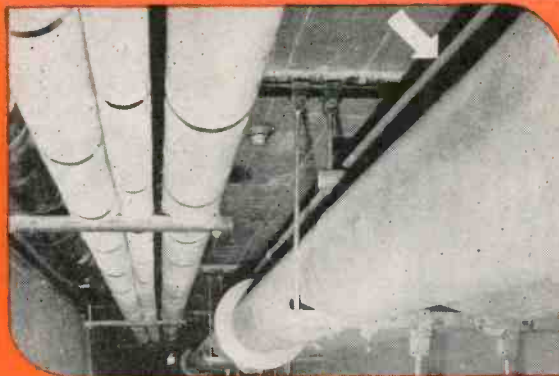

OKOGLASS insulation, which cannot burn or give off flammable gases, protects cables in hot locations, as near steam lines.

4009

# PORTABLE POWER PROBLEMS

THIS MONTH—THE SOUND-LEVEL METER



**BURGESS INDUSTRIAL BATTERIES** meet every power requirement for the conveniently portable sound-level meter. Used for qualitative measurement of sound, the meter consists essentially of a sound pickup, a special electronic amplifier and an indicating instrument. Burgess Industrial Batteries give dependable, long service life in hundreds of electronic industrial applications—they meet every requirement for test and control instruments.

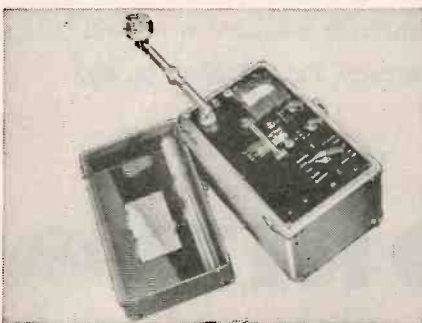

**ENGINEERS CHOOSE BURGESS** Industrial Batteries for the operation of portable instruments—recent surveys of dry battery preferences reveal that Burgess is the first choice of electronic experts! Burgess engineers will develop batteries for any special problem you may have, although most needs can be readily served from the standard line available through your Burgess distributor. *Burgess Battery Company, Freeport, Illinois.*

CAREFUL BUYING KEEPS PRICES DOWN!

## BURGESS BATTERIES

VOTED FIRST BY ENGINEERS  
IN NATION-WIDE INDUSTRIAL BATTERY SURVEY

Recognized as the MOST COMPLETE LINE of dry batteries



R-F BRODGES

(continued)

nate with the above.

Resistance: 10 ohms to 10 megohms.

### V H F Circuit

An ultra-short-wave admittance bridge appears in Fig. 5. In this instrument, the input and output transformers both have a ratio of 3:1, giving a total of 9:1. This ratio enables a capacitor of low inductance to be used as a standard, and the value of resistance is also more convenient. Capacitors  $C_1$  and  $C_2$  are the standards, of 60

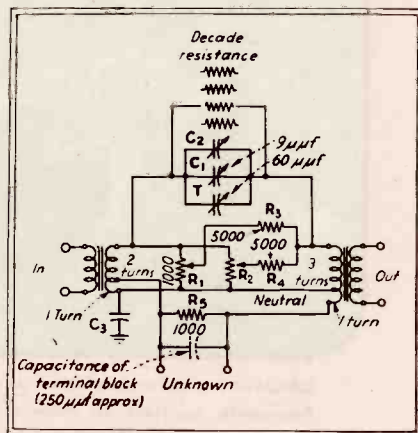

Fig. 5—An accuracy of five percent over a range of frequencies from 100 kc to 100 Mc is claimed for this bridge circuit

and  $9 \mu\text{f}$  respectively, but the  $9\text{-}\mu\text{f}$  capacitor is calibrated from 0 to  $70 \mu\text{f}$  (the capacitance which it balances), and the  $60\text{-}\mu\text{f}$  unit is calibrated from 0 to  $500 \mu\text{f}$ . Owing to the necessity for reducing internal inductance in the bridge, the capacitance of the  $60\text{-}\mu\text{f}$  unit at half scale, plus the zero capacitance of the small capacitor and that of a trimmer, is balanced by the capacitance of about  $250 \mu\text{f}$  across the unknown terminals, which is obtained by making the leads and the massive terminals in one unit, spaced by a sheet of mica.

Groups of carbon resistors are used for the resistance balance and there is a continuous adjustment of resistance balance with a potential divider. Great care is taken in wiring, to reduce the inductance and stray fields. All leads are of copper tape and external leads are kept very close together.

A 30-ohm carbon resistor is used as the resistance standard, its ends

# Silver-Graphite BRUSH HEADQUARTERS

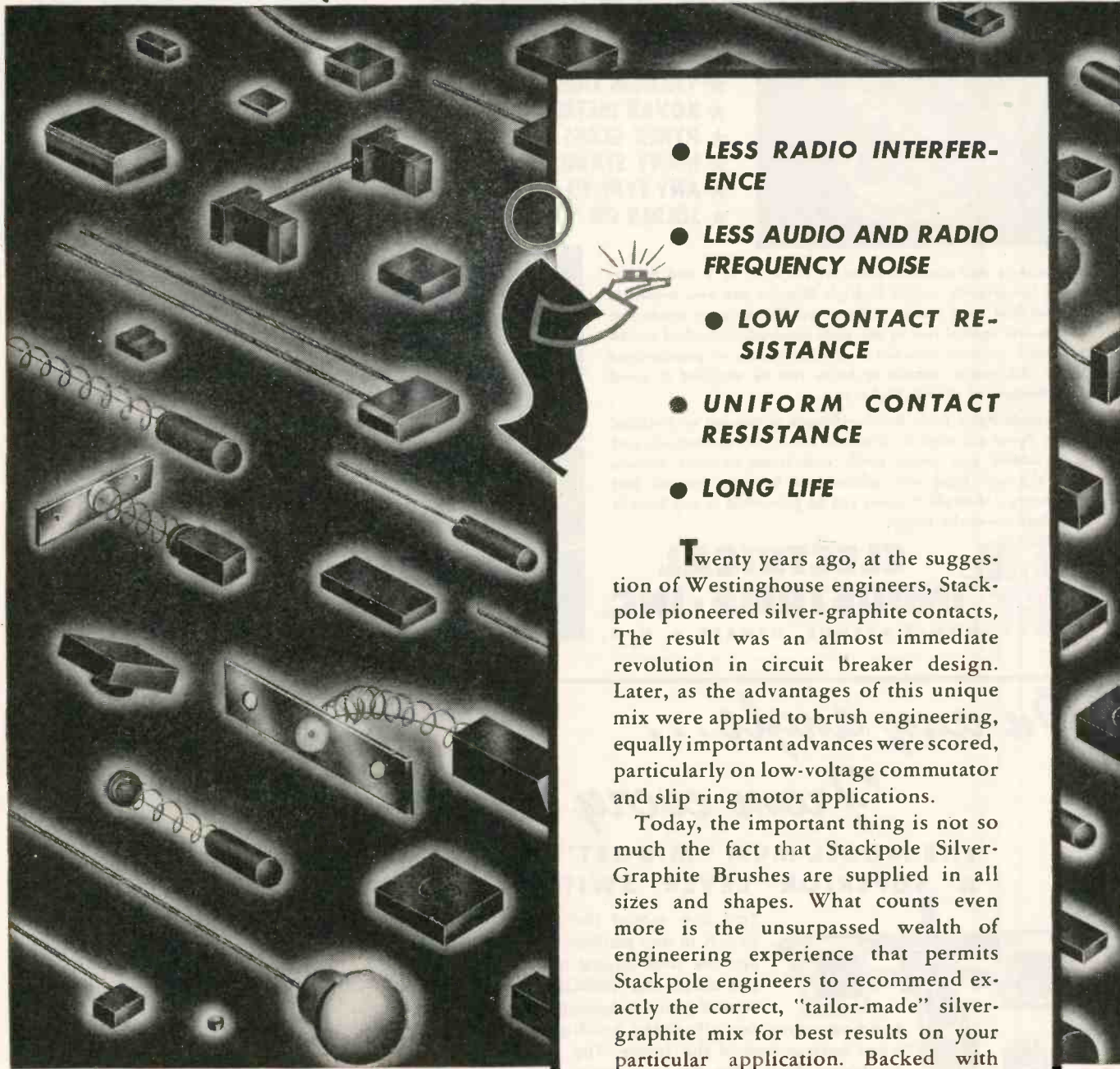

- LESS RADIO INTERFERENCE
- LESS AUDIO AND RADIO FREQUENCY NOISE
- LOW CONTACT RESISTANCE
- UNIFORM CONTACT RESISTANCE
- LONG LIFE

Twenty years ago, at the suggestion of Westinghouse engineers, Stackpole pioneered silver-graphite contacts. The result was an almost immediate revolution in circuit breaker design. Later, as the advantages of this unique mix were applied to brush engineering, equally important advances were scored, particularly on low-voltage commutator and slip ring motor applications.

Today, the important thing is not so much the fact that Stackpole Silver-Graphite Brushes are supplied in all sizes and shapes. What counts even more is the unsurpassed wealth of engineering experience that permits Stackpole engineers to recommend exactly the correct, "tailor-made" silver-graphite mix for best results on your particular application. Backed with complete details of your equipment, they welcome the opportunity to submit Silver-Graphite Brush (or Contact) samples for test. You be the judge!

**STACKPOLE CARBON COMPANY**  
ST. MARYS, PA.

**BRUSHES AND CONTACTS**  
(All carbon, graphite, metal,  
and composition types)

**RARE METAL CONTACTS**

**BEARINGS WELDING CARBONS**

**PACKING, PISTON AND SEAL RINGS**

**CONTINUOUSLY ADJUSTABLE  
CARBON RHEOSTATS**

**CHEMICAL CARBONS**

**CARBON PIPE POWER TUBE ANODES**

**MOLDED SPECIALTIES, etc.**

# STACKPOLE

MOLDED METAL POWDER AND CARBON PRODUCTS

# E-I HERMETICALLY SEALED MULTIPLE HEADERS

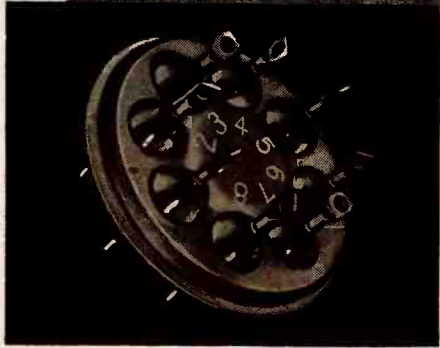

- ★ VACUUM TIGHT SEAL
- ★ KOVAR METAL ELECTRODES
- ★ PYREX GLASS BEAD
- ★ MANY STANDARD TYPES
- ★ ANY TYPE TO SPECIFICATIONS
- ★ SOLDER OR WELD EASILY

A complete and diversified line of E-I 4, 5, 6, 7 and 8 electrode hermetically sealed Multiple Headers are now available as standard stock items. All are supplied at mass production prices—no special tool or die costs involved. Individual sealed terminals are also included in a wide variety of standardized types. All special shapes or forms can be supplied to exact specifications at slightly higher cost.

All include Pyrex glass bead—immune to thermal or electrical shock. Pyrex annealed to eliminate strain. Kovar electrode and shell solders and welds easily and forms absolute vacuum tight chemical bond with glass—lead becomes integral part of housing. Multiple Headers can be fabricated in any form to specification—write today.



**ELECTRICAL  
INDUSTRIES • INC.**

42 SUMMER AVENUE, NEWARK 4, N. J.

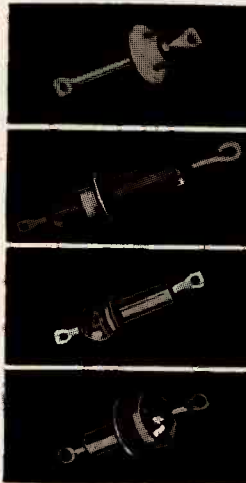

More than  
**20 Portlands**  
in the U.S.A.!

WHICH Portland do you have in mind? The item you want to Express is valuable, to you and its consignee. Pause a moment! Take another look at the address and ask yourself — "Is this shipment clearly and securely marked?" A few moments spent in making sure can prevent unavoidable delays — and even loss. It is the address which guides the shipment to its destination. For further information, inquire of your local Railway Expressman. He is a good man to know.

BUY MORE WAR BONDS



NATION-WIDE

RAIL-AIR SERVICE

*On any angle...  
From every angle*

## THE MODEL MCM "MIDGET" IS A SUPERIOR LEVER SWITCH



You can mount the MCM "MIDGET" switch in any position that is *easiest to operate and easiest to assemble*—you can mount the "MIDGET" frame on the control panel *independent* of the contact

build-ups—you can attach the build-ups to the chassis wires *independent* of the frame. The two sections are combined during the final assembly operation with a *single bolt*. One hole only is required in the panel for mounting. The "MIDGET" weighs but 3½ ounces with 12 contact springs. The same switch measures but 1¼" in width, 1⅜" in height, and 4⅓" in length!

Regardless of your light duty switching requirements, you will find the "MIDGET" a superior switch from every angle, because it can be mounted at any angle and still give outstanding performance with long life. Write for details!

Illustrations (top to bottom) show the MCM (1) electrically-manually operated, (2) right angle mount, (3) watertight mount, and (4) with snap-action contacts.

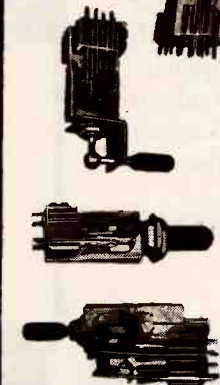

**GENERAL CONTROL COMPANY**

1202 SOLDIERS FIELD ROAD, BOSTON 34, MASS



Thermoplastic insulation specialists . . . producing a complete line from fine wires to heavy power cables . . . serving: Public Utilities, Radio, Electronic, Appliance and Instrument Manufacturers, Telephone Companies and Contractors.

*Now*

## THERMOPLASTIC INSULATION

Nothing is constant but change . . . and in the wire and cable field the "change" to thermoplastic insulation has been tried and proved in the test tube of war. When victory is won you will demand the maximum resistance which these new compounds and constructions offer to heat, flame, oxidation, chemical action, oil, grease, moisture, cold, abrasion, fungus growth and other severe conditions. Write NOW for complete information and samples engineered to your particular requirements. Remember . . . when you're thinking of PLASTIC you're thinking of US!

# PLASTIC

WIRE & CABLE  
CORPORATION

NORWICH CONN





## LET US HELP YOU WITH YOUR CRYSTAL CONTROLLED CIRCUITS

The public may be very happy just to have a new automobile. But they are conditioned to expect the postwar domestic radio to be different — with the precision and quiet of Crystal Controlled circuits.

Through the war we have learned a lot about the use of Control Crystals, and this knowledge is at the disposal of manufacturers of radio, fm and other electronic devices.

And when you know what crystals you need, our quantity-production methods are ready to supply you with crystals to your exact specifications, on time, clean, and at a price that will be within your production budget.



**PAN-EL**ectronic **LAB**oratories, Inc.

500 SPRING STREET, N. W.

ATLANTA, Ga.

QUANTITY PRODUCERS OF STANDARD AND SPECIAL

# Control Crystals

being cased in copper to neutralize inductance. It is non-reactive up to 60 Mc.

To measure the internal inductance of the bridge, a measurement is made of an inductance and a resistance in series. This is provided by a single turn of 46 SWG eureka wire on a 3/8 inch former. The inductance can be calculated and the resistance measured on d-c and calculated for high frequencies.

The accuracy of the bridge is not worse than 5 percent and is considered fairly good for the frequencies covered (100 kc to 100 Mc) and for such a simple piece of equipment. Ranges are as follows:

Capacitance—Up to 300  $\mu\text{f}$ .

Shunt Resistance—10 to 10,000 ohms.

Inductance—Such as will resonate with the above capacitances.

### Inductance Measurements

A medium and long-wave low impedance bridge is given in Fig. 6. This bridge covers the frequency range from 100 kc to 2 Mc and is designed particularly for low-

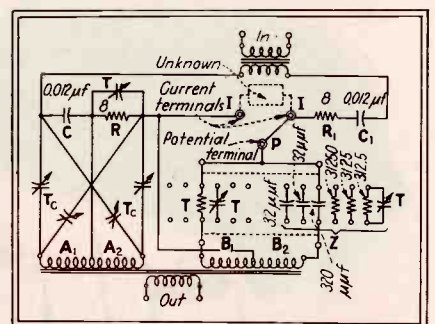

Fig. 6—Low values of inductance as well as the resistive component are measured by this circuit. Capacitance may also be measured by changing the calibration of the dial. Capacitors marked T are trimmer types

inductance measurements. It also measures the resistive component. Capacitance measurements can be made but the dial readings are in reciprocal capacitances.

The method is to determine the potential difference across the unknown impedance and to compare this with the current through it. Independence between the circuits is achieved (like the Kelvin double bridge) and this enables mutual inductance to be measured. It also



# Flow Chart for Quality Control

Efficient control over the quality of precision springs requires active and intelligent application of statistical methods, using testing and measuring devices possessing accuracy and speed standards unheard of less than three years ago.

These new inspection techniques have been in full use at Hunter for some time.

The development and manufacture of our own new electronically-operated devices reached such proportions that we had to create a new "Special Apparatus" department to handle the work.

Below, you see how the quality function ties into the manufacturing cycle. The artist's drawing is based on an actual flow chart for close tolerance compression springs.

Typical Control Chart Station at Hunter for measuring free length and load

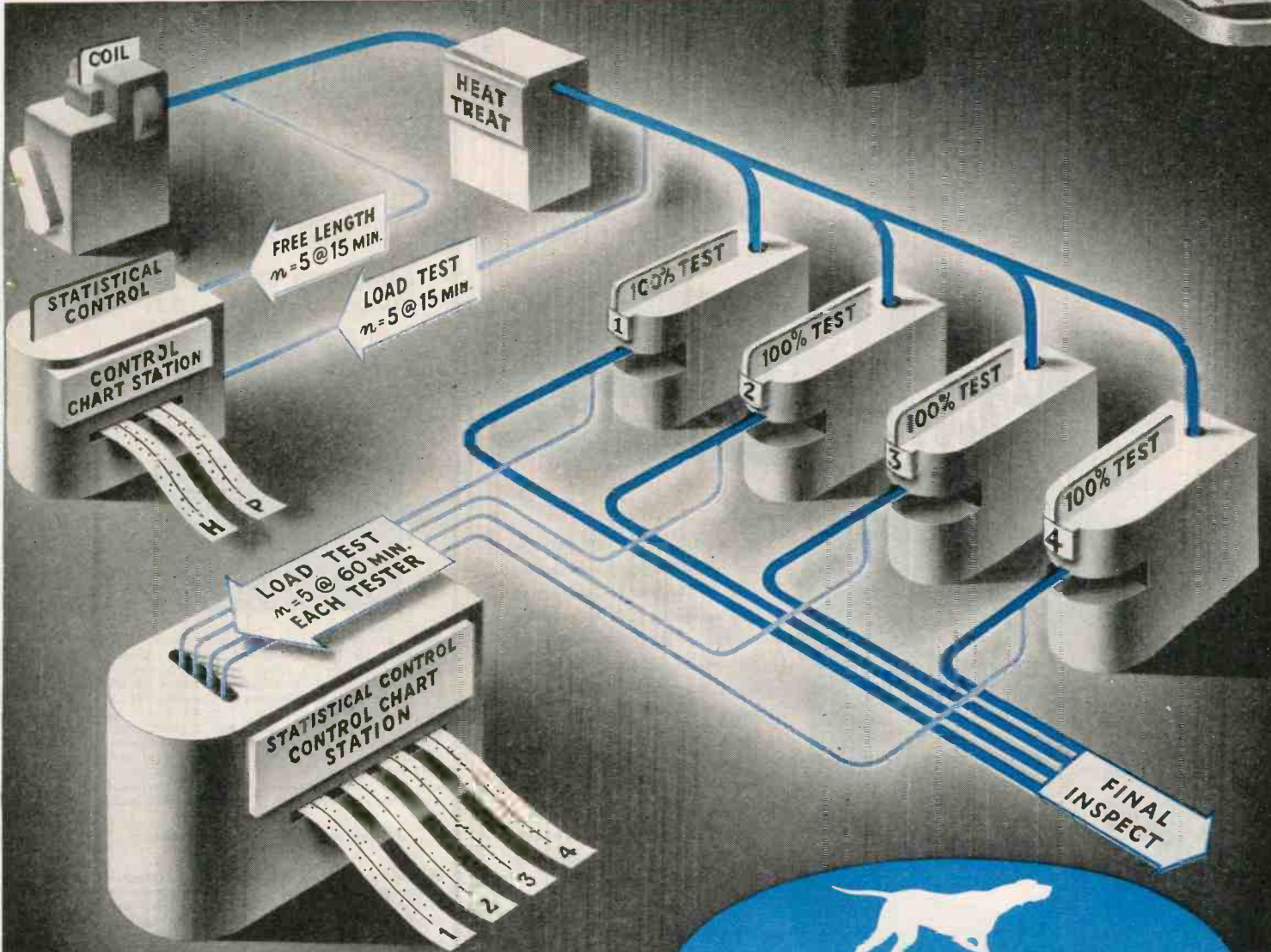
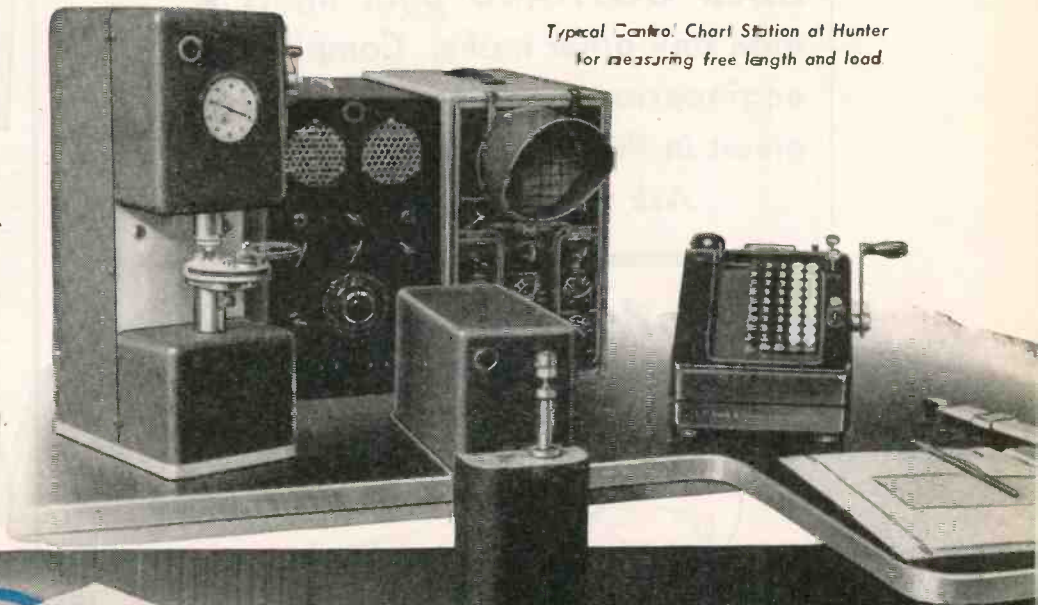

HUNTER PRESSED STEEL COMPANY, LANSDALE, PENNA.

Springs, Metal Stampings, Wire Forms, Mechanical and Electrical Assemblies.



There are more Underwriters Listed **GOTHARD** pilot lights than any other make. Complete engineering and lamp data is given in the **GOTHARD** catalog

Ask for your copy.

**Gothard**

MANUFACTURING COMPANY

1310 NORTH NINTH ST. SPRINGFIELD, ILL.

EXPORT DIVISION

25 WARREN ST., NEW YORK 7, N. Y.



When it comes to **TRANSFORMERS** for **BLIND LANDING EQUIPMENT...**

• Manufacturing transformers for blind landing equipment calls for the best in engineering and designing skill. An exacting production job, it is indicative of the specialized transformer and wave filter technique that has made Electronic Engineering Co. the leader.

Now, all production of this and other specialized transformers is going to the war effort — Tomorrow, this outstanding equipment will be available for every civilian application.

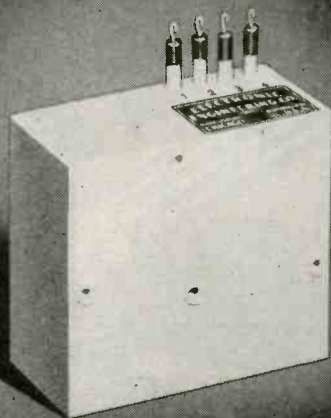

**ELECTRONIC**

**ENGINEERING CO.**

3223-9 WEST ARMITAGE AVENUE  
CHICAGO 47, ILLINOIS

"SPECIALIZED *Transformer* ENGINEERS"

## FACTS about

**5 Eastern PUMPS FOR VACUUM TUBE COOLING SYSTEMS**

These five different models of small centrifugal pumps designed for circulating water through the cooling systems of communications and X-ray tubes are representative of Eastern Pumps. Other pumps for special purposes have been designed. May we have the opportunity to design special pumps for your needs where reasonable quantities are involved?

### AIRBORNE MODELS

(Designated as AR Series)

These are designed in conformance with Army-Navy standards.



The pump and motor are one integral unit weighing but two and one-third pounds and measuring over-all 5 3/8" x 4 1/2" x 2 1/4".

Performance up to 11 P. S. I. and up to 5 gallons per minute. Models are available in standard 12 and 24 volt D. C. ratings. Shown are performance curves for the AR2, AR3, and AR4. All models have long life and are rated for continuous duty with the exception of model AR4, which under 8 P. S. I. is rated for intermittent duty.

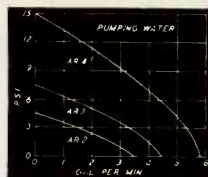

### LAND AND SEA MODELS

(Designated as E-1 and E-7)

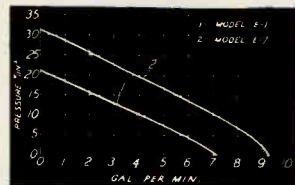

Both are centrifugal pumps, powered by General Electric Universal motors. Model E-1 is 7" x 3 3/4" x 3 9/16", 1/15 H. P., weighs 6 lbs. and has a Maximum Pressure of 20 P. S. I. with a Maximum Capacity of 7 G. P. M. Model E-7 is 9" x 4" x 4", 1/8 H. P., weighs 8 lbs. and has a Maximum Pressure of 30 P. S. I. and a Maximum Capacity of 9 G. P. M. They are equipped with mechanical rotary seals which completely seal the pumps against leakage. Obtainable with motors to meet Navy Specifications.

All five models have the following characteristics:

Extremely light weight, compact, integral pump and motor unit, varied performances available, optional voltages, long life, dependable operation, universal mounting.

The curves shown are those for which production is now standard, it is readily possible to obtain other characteristics where quantity is involved.

**Eastern ENGINEERING COMPANY**  
84 FOX STREET - NEW HAVEN, CONN.

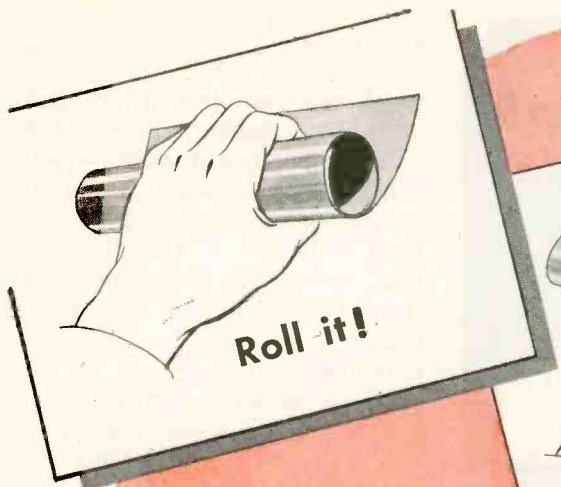

Roll it!

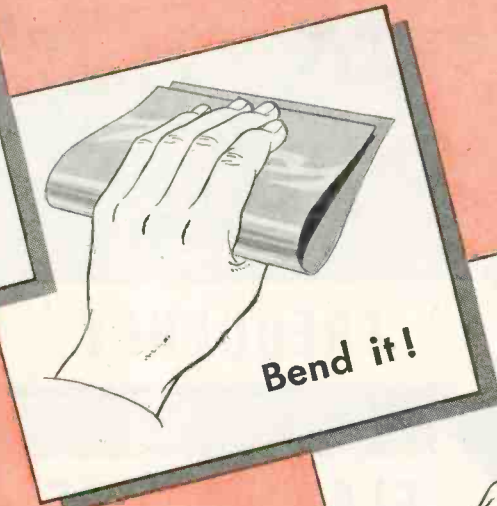

Bend it!



Crease it!

## *A smoothie...* but it takes rough treatment

You can form DOBAR laminated insulation paper into almost any shape without damaging its smooth surface or changing its electrical characteristics. It slides readily into small, confined spaces with minimum pressure and friction, making it quick and easy to handle.

The laminated moisture-barrier of cellulose acetate film increases dielectric strength to 70% better than standard paper, under ordinary conditions. At 85% RH and 85° F., DOBAR tests up to 296% better. Leakage tests under the same conditions show an improvement of 327%. With its high resistance to moisture, solvents, weak acids, mineral oils and similar dangers, DOBAR effectively increases your margin of safety.

These DOBAR advantages apply wherever you use insulation paper. Send for samples to test on your own applications.

### **7** DOBAR ADVANTAGES

- 1** High dielectric strength
- 2** ... especially in high humidity
- 3** Low current leakage
- 4** Easy to work, especially in tight spots
- 5** High resistance to abrasion
- 6** Noncorrosive
- 7** Less space required for same insulation efficiency

**DOBAR IMPROVES YOUR  
FACTOR OF SAFETY**

DOBAR insulation is a permanent lamination of cellulose acetate film to standard insulation paper. Made by the makers of LEXEL insulation tape.

TRADE-MARK  
**DOBAR**

*Insulation*

A new name for an old product of THE DOBECKMUN COMPANY

Industrial Division . . . Cleveland 1, Ohio



# NEW METER

*Indicates*

**BOTH**

**FREQUENCY**

**ELAPSED TIME**

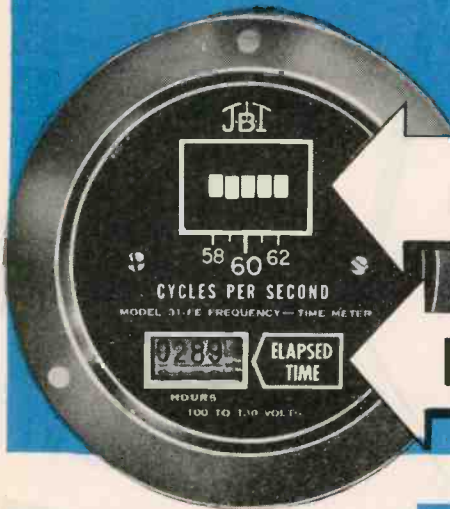

● Saves panel space and weight — one instrument does the work of two

● Insures operation of equipment at proper speed, within  $\pm 0.3\%$

● Eliminates breakdowns caused by failure to lubricate, maintain and overhaul—on schedule

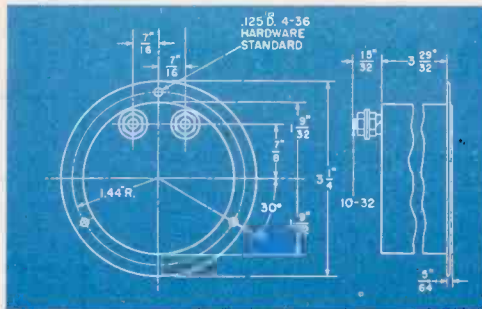

Size...  $3\frac{1}{4}$ " flange diameter. Black metal case for flush-panel mounting. 5 reeds... 58-62 cycle range. Accuracy...  $\pm 0.3\%$ . Power consumption... 3 watts, 110 volt operation. Weight... 1.3 lbs. Also made for 59-61, 48-52, and 49-51 cycle ranges.

This combination running time and frequency meter is just one of the variations J-B-T has pioneered for specific field and laboratory use in measuring speed, temperature and frequency. This and 17 other interesting applications are illustrated in a new bulletin, now ready.

They may suggest ways to attack your own problems... through use of J-B-T's wide engineering "know how," laboratory set-up and production capacity. Ask for Bulletin VF 43-IC.

**P.S.** Perhaps you would also like to have Bulletins VF-43 describing basic Vibrating Reed Frequency Meters and their operation, VF 43-IA on 400 cycle meters and VF 43-IB on the smallest frequency meters made. They're yours for the asking too.



## J-B-T INSTRUMENTS, INC.

431 CHAPEL STREET • NEW HAVEN 8, CONNECTICUT

1-JBT-1

R-F BRIDGES

(continued)

means that the internal inductance of the instrument is unimportant.

An input transformer supplies current to pass through the unknown impedance, via a  $0.125\text{-}\mu\text{f}$  fixed capacitor  $C$  and an 8-ohm fixed resistor  $R$ . Capacitor  $C_1$  and resistor  $R_1$  balance the circuit with respect to ground. The drop across  $C$  is applied to a  $400\text{-}\mu\text{f}$  variable capacitor in series with one winding of a summation transformer, and the drop across  $R$  is applied to a second  $400\text{-}\mu\text{f}$  variable capacitor and another winding on the transformer. The resultant core flux is therefore a measure of the amplitude and phase of the current through  $C$  and  $R$ .

A third winding on the transformer takes the drop across the unknown impedance, via a fixed resistor  $Z$ , producing a current proportional to and in phase with the voltage across the unknown. When the two variable capacitors are adjusted so that the amplitude and phase of the currents in the transformer windings produce a flux, equal in amplitude and opposite in phase to the flux from the third winding, the resultant flux will be zero and a null balance will be obtained.

The values of the two variable capacitors and the resistance of  $Z$

## SOUND TRUCK

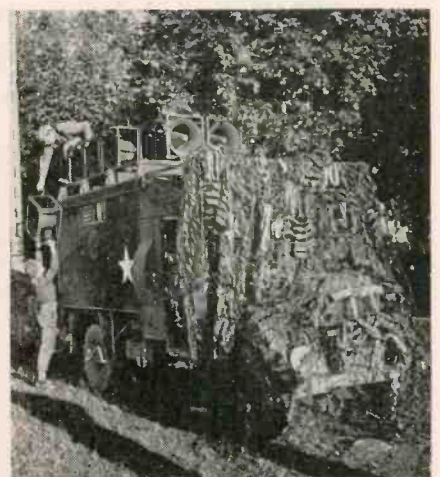

The psychological warfare branch of the British Army used this camouflaged truck to make announcements in German and Polish to the enemy. Hung in trees, the speakers called upon soldiers to surrender

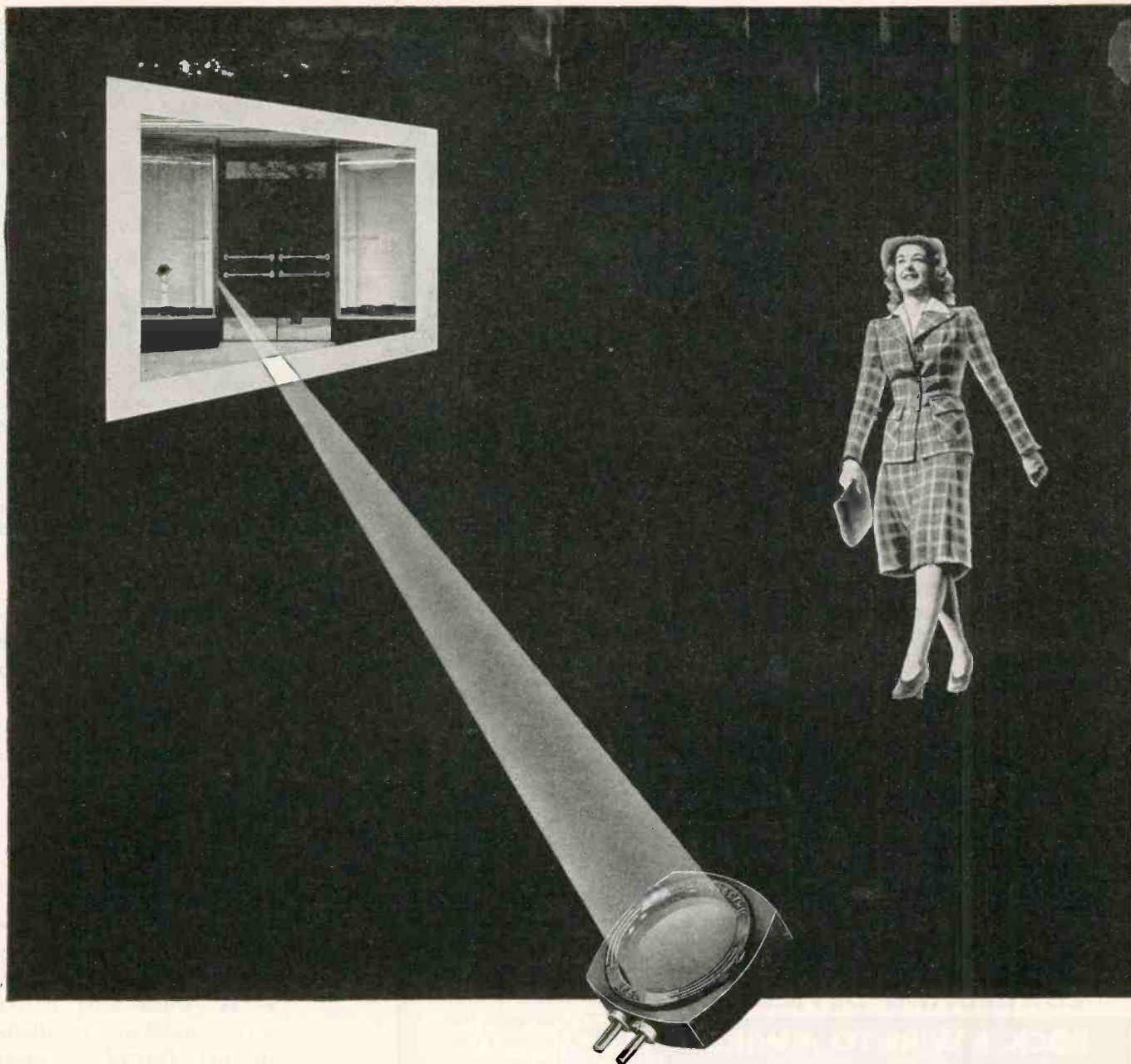

## How to beat a woman—TO A DOOR

One way to startle the lay public into awed pleasure is to show them a door opened by means of a photocell.

The practical beauty of this stunt is that you can do it over and over again without failure, even where shattering vibrations exist as part of normal operating conditions. For the Luxtron\* photocell is really rugged.

Another advantage is that Luxtron photocells convert light into electric

energy for the direct operation of meters and meter relays without amplification. They are lightweight, too. They are a good way to beat competition to a customer.

If you have any control problem that has defied solution with a simple, durable piece of apparatus, perhaps Bradley can throw some light on it—and make that light do the work for you. Write for literature and samples.

\* T. M. REG. U. S. PAT. OFF.

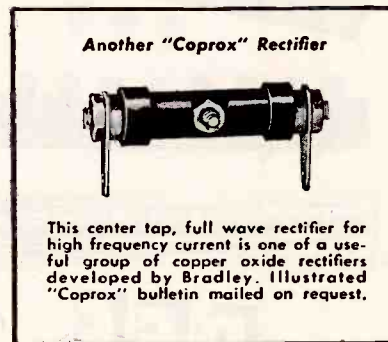

PHOTOCELLS—MASTERS OF LIGHT

# BRADLEY

MASTER OF PHOTOCELLS

BRADLEY LABORATORIES, INC., 82 MEADOW STREET, NEW HAVEN 10, CONNECTICUT

## COAT TURNTABLES and GRILLS

with

# Cellusuede FLOCK



Here's the ideal material for coating phonograph turntables and grills! It protects records, eliminates slipping, and provides a rich, velvety finish at low cost. Cellusuede can be applied to almost any surface, easily and economically, by sifting or spraying. Both Rayon and Cotton Flock available for immediate shipment in a wide assortment of eye-catching colors. No rationing . . . no priorities . . . No delay.

Send for Booklet,  
Color Card,  
Samples and Prices

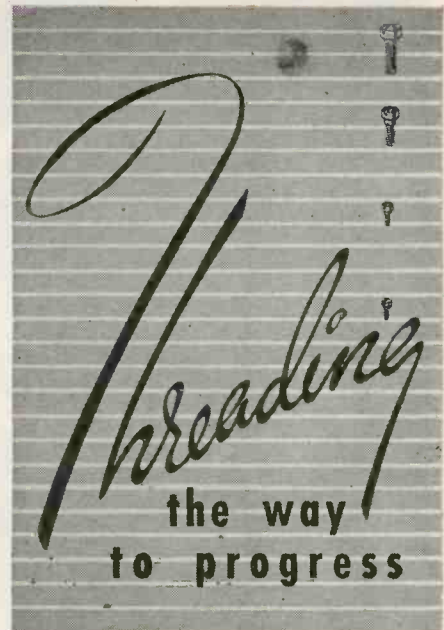

### Screw Machine Products:

- Screw machine products have now entered the field of electronics in volume.
- Experienced Producers of screw machine products are essential to expedite efficient operation.

Your Source—

### Waltham Screw Company because:

- Of sufficient equipment to produce in any quantity screws, tubes, shafts, inserts, nuts and other screw machine products in any thread to meet close tolerance requirements.
- Our experience gained in over half a century of development and production of screw machine products is now available to you in the electronics fields.

Send for our catalog and call upon our Engineering Staff for solutions to your problems in screw machine products.

**WALTHAM SCREW  
COMPANY**  
75 Rumford Ave.  
Waltham, Mass.

## NEW! The ULTIMATE in SOLDERLESS CONNECTING DEVICES LOCK A WIRE TO A WIRE

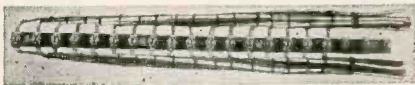

Write  
for SAMPLES  
and data

L. S. BRACH MFG. CORP., Newark 4, New Jersey

When the Bee nut is screwed down all the way, its built-in clamp locks a wire to a wire. No danger of loose strands. Assures a vibration-proof, low resistance connection.

SPACE-  
SAVING TIME-  
SAVING

Simply lay stripped ends of two or more wires into slot. The Bee nut will clamp them together permanently or until you want them apart. No lugs, lock nuts or lock washers required. No soldering, crimping, pressing or insulating.

# New Formica Grades



RESIST MORE  
HEAT!

**P**ROGRESS has recently provided new resins and new fibre bases that have greatly increased the heat resistance of insulating grades of Formica. They will take without injury about 25 percent higher temperatures.

An example of this improvement is FF-55, produced to conform to Navy Grade GMC made with a glass fibre base and melamine resins. It withstands 440 degrees Fahrenheit for a short period, and 390 degrees continuously.

In this same material Arc resistance reaches a new level — by ASTM test D495-42, it is rated at 185 seconds.

The material is strong, and can, therefore, be used to take structural stresses when the design makes that desirable. Test figures: Tensile strength 25,000 P.S.I.; Compressive strength (flatwise) 90,000 p.s.i.; Flexural strength (flatwise) 30,000 p.s.i.; Modulus of Elasticity in bending 3,000,000 p.s.i.; Izod impact, 12 ft. lbs. per inch of notch.

This is a new combination of useful qualities, not previously available in one material. Unlike some materials which possess some of these characteristics, the material can be easily punched and machined. It is suitable for rapid fabrication by production methods.

THE FORMICA INSULATION COMPANY, 4661 SPRING GROVE AVENUE, CINTI. 32, O.



will be a measure of the reactance and resistance of the unknown impedance.

#### Capacitance Measurements

To measure capacitance, the resistor  $Z$  is replaced by a fixed capacitor, which interchanges the dial indications of the two variable capacitors. The one which indicated resistance then gives reciprocal capacitance and that which indicated inductance then reads resistance.

Range of the bridge is dependent on the value of the resistor  $Z$  (or the capacitor which replaces it), according to the following table:

Standard $Z$	Range of measurement
312.5 ohms resistance...	0-10 ohms; 0-1 $\mu$ h
3,125 ohms resistance...	0-100 ohms; 0-10 $\mu$ h
31,250 ohms resistance...	0-1,000 ohms; 0-100 $\mu$ h
320 $\mu$ mf.....	0-10 ohms; 10,000 $\mu$ mf to infinity
32 $\mu$ mf.....	0-100 ohms; 1,000 $\mu$ mf to infinity
3.2 $\mu$ mf.....	0-1,000 ohms; 100 $\mu$ mf to infinity

Accuracy of measurement is reasonably high for most laboratory work and the bridge is easy to use. For high-Q circuits, however, the accuracy of resistance measurement is not good, since the range of resistance measured is not independent of the range of inductance measured. This difficulty can be overcome.

• • •

#### TESTING WIRE



The insulating value of the enamel coating on fine wire produced at the Dobbs Ferry plant of North American Phillips is checked on this instrument

## Here's why SPERTI HERMETIC SEALS are A "MUST" IN THE TROPICALIZATION OF ELECTRONIC MILITARY EQUIPMENT

1. EFFECTIVELY SEAL OUT DUST, sand, salt spray, fumes, fungus, injurious atmosphere.
2. GLASS PATH WILL NOT CARBONIZE. Have wide thermal operating range and high insulation leakage resistance.
3. SPECIAL PROCESS insures maximum acceptability to solder. Simple and easy to attach.

Sperti Hermetic Seals have been an important factor in increasing the life expectancy and usefulness of vital military equipment of many kinds. Write, today. Outline your problems. Let us show you how Sperti Hermetic Seals can help you solve them.

### THE HELP YOU'VE BEEN LOOKING FOR!

Now available. Skilled assembly service for soldering terminals into cover plates. Send drawings and specifications for quick quotation. For full information, phone, wire or write.

# Sperti

INCORPORATED  
Cincinnati, Ohio



RESEARCH • DEVELOPMENT • MANUFACTURING



# THEIR FAVORITE BLONDE

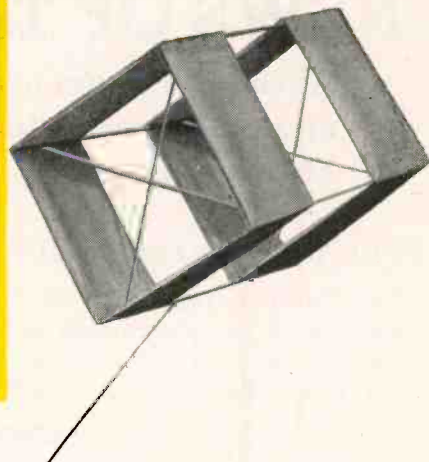
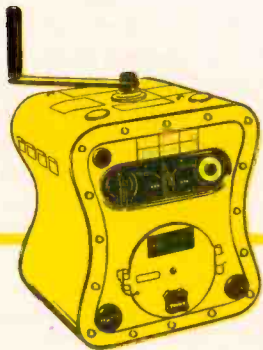

**THIS IS THE GIBSON GIRL\*** with her hourglass shape and a bright yellow dress . . . the magic emergency radio transmitter which automatically sends out S-O-S signals by merely turning the hand crank. ☆ Now carried on overwater flights by most military planes, Gibson Girls have snatched back to life many American, Canadian and British crews forced down at sea, ☆ The hand crank generates sufficient power to transmit signals over a 100,000 square mile area, and to light a brilliant signal light. Manual keying on radio transmission is available. The unit is equipped with parachute for release from a rescue plane or before a crash landing. ☆ More than 60,000 Gibson Girls have been produced by Pacific Division since they were developed by this company before Pearl Harbor. Such outstanding radio developments as this demonstrate Pacific Division's unique ability to successfully solve new radio problems. Our engineers—now specializing in VHF communications systems—are available to assist you with your radio problems.

\*Trade Mark Reg. U.S. Pat. Off.

All rescued airmen become members of the most exclusive fraternity in the world—the Order of Gibson Girls. They receive this certificate and a gold lapel pin. If you have been rescued or know someone who has, write today to the Order of Gibson Girls, North Hollywood, California, for membership.

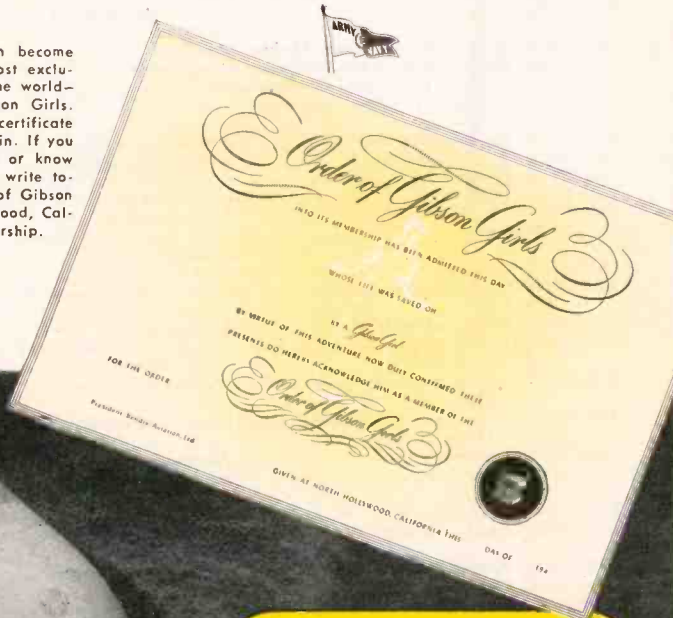
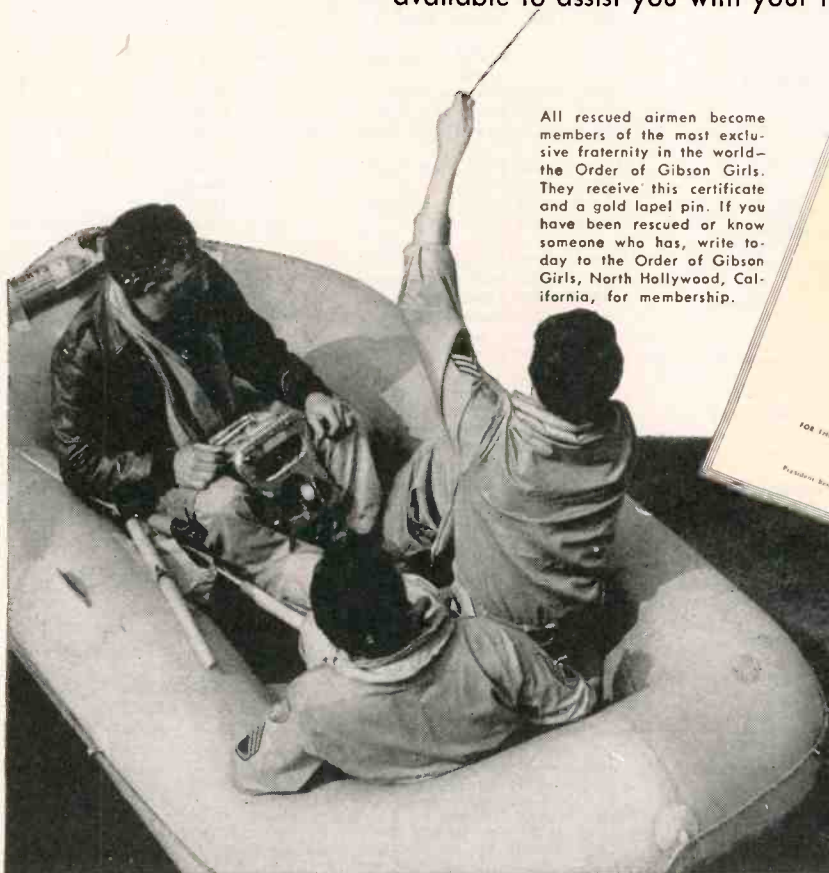

**Pacific Division**  
Bendix Aviation Corporation  
NORTH HOLLYWOOD 7, CALIF.

# NEWS OF THE INDUSTRY

**Alien patents; fm-television truce; therapeutic music; fluorescent fungicides; Washington and FCC news; business and personnel activities**

## FCC Releases Proposed Allocations Below 25,000 Kc

THE PROPOSED ALLOCATION of frequencies to non-government radio services operating in the portion of the radio spectrum below 25,000 kilocycles, as released May 21, is given in the table below. After all oral arguments have been heard, starting in June, the Commission

will issue a final allocations report covering non-governmental radio services in this portion of the spectrum.

Highlights of the FCC proposals include addition of another radio channel to the lower end of the present standard broadcast band, at 540 kc; provision of 120 radio channels, some of which will be available to the United States, for direct international short-wave broadcasting; allocation of frequencies for use by radio amateurs and others during

### PROPOSED FCC ALLOCATIONS BELOW 25,000 KILOCYCLES

Freq. in kc	United States Allocations	Proposed International Allocation	Freq. in kc	United States Allocations	Proposed International Allocation
Up to -100	Fixed	Fixed	6300-6450	Fixed, aero. fixed	Fixed
100-160	Coastal, marine relay, ship, mobile press, fixed Alaskan	(a) Fixed (b) Maritime mobile	6450-6600	Aeronautical mobile (6)	Aeronautical mobile (6)
160-200	Fixed (1)	Fixed (1)	6600-6900	Fixed, aero. fixed	Fixed
200-280	Air navigation aids	Air navigation aids	6900-7000	Government (8)	Aeronautical mobile (8)
280-320	Maritime beacons	Maritime beacons	7000-7300	Amateur	Amateur
320-415	Air navigation aids	Air navigation aids	7300-8200	Fixed, aero. fixed, Alaskan	Fixed
415-490	Coastal, marine relay, ship	Maritime mobile (telegraphy)	8200-8275	Coastal, marine relay, ship	Maritime mobile
490-510	Mobile (distress & calling freq. 500 kc)	Mobile (distress & calling freq. 500 kc)	8275-8285	Mobile (distress and calling freq. 8280 kc) (5)	Mobile (distress and calling freq. 8280 kc) (5)
510-535	Mobile (telegraphy) (2)	Mobile (telegraphy) (2)	8285-8700	Coastal, marine relay, ship, mobile press	Maritime mobile
535-1605	Broadcasting (non-gov.) (3)	Broadcasting (3)	8700-8900	Aeronautical mobile (6)	Aeronautical mobile (6)
1605-1800	Police, aviation, relay broadcast, special, Alaskan, disaster communication including amateur disaster networks	Fixed, mobile	8900-9000	Fixed, aero. fixed, coastal telephone	Fixed, maritime mobile (10)
1800-2000	Navigation aids	Navigation aids	9000-9500	Fixed, aero. fixed	Fixed
2000-2050	Government (4)	Fixed, mobile (4)	9500-9700	International broadcast	International broadcast
2050-2065	Ship telegraph	Maritime mobile	9700-9990	Fixed, aero. fixed	Fixed
2065-2075	Mobile (distress and calling freq. 2070 kc) (5)	Mobile (distress & calling freq. 2070 kc) (5)	9990-10010	Government	Standard freq. broadcast on 10000 kc
2075-2100	Ship telegraph	Maritime mobile	10010-10200	Government (8)	Aeronautical mobile (8)
2100-2250	Ship telephone, relay broadcast	Mobile	10200-11300	Fixed, aero. fixed	Fixed
2250-2300	Police point-to-point, ship telephone, aviation, special, relay broadcast	Fixed, mobile	11300-11500	Aeronautical mobile (6)	Aeronautical mobile (6)
2300-2350	Coastal telegraph, marine relay	Maritime mobile	11500-11700	Fixed, aero. fixed	Fixed
2350-2495	Police, ship telephone, Alaskan	Mobile	11700-11900	International broadcast	International broadcast
2495-2505	Government	Standard freq. broadcast on 2500 kc	11900-12300	Fixed, aero. fixed	Fixed
2505-2700	Coastal harbor telephone, Alaskan	Mobile	12300-12415	Coastal, marine relay, ship	Maritime mobile
2700-2850	Fixed, maritime mobile telephone, police point-to-point, special emergency, relay broadcast, Alaskan	Fixed, mobile	12415-12425	Mobile 12420 kc (5)	Mobile (calling freq. 12420 kc)
2850-3125	Aeronautical mobile (6)	Aeronautical mobile (6)	12425-12950	Coastal, marine relay, ship, mobile press	Maritime mobile
3125-3200	Aeronautical fixed (7)	Aeronautical fixed (7)	12950-13050	Government (8)	Aero. mobile (8)
3200-3330	Government (8)	Aeronautical mobile (8)	13050-13250	Fixed, aero. fixed	Fixed
3330-3450	Forestry (9)	Mobile, except maritime and aeronautical (9)	13250-13350	Fixed, aero. fixed, coastal telephone	Fixed, maritime mobile (10)
3450-3500	Government	Fixed, and mobile except maritime	13350-14000	Fixed, aero. fixed (11)	Fixed (11)
3500-4000	Amateur	Amateur	14000-14400	Amateur	Amateur
4000-4100	Fixed, except aeronautical fixed	Fixed, except aeronautical fixed	14400-14985	Fixed, aero. fixed	Fixed
4100-4135	Coastal, marine relay, ship	Maritime mobile	14985-15015	Government	Standard freq. broadcast on 15000 kc
4135-4145	Mobile (distress and calling freq. 4140 kc) (5)	Mobile (distress and calling freq. 4140 kc) (5)	15015-15100	Government (8)	Aero. mobile (8)
4145-4500	Coastal, marine relay, ship, mobile press	Maritime mobile	15100-15300	International broadcast	International broadcast
4500-4890	Fixed, aero. fixed, coastal telephone, Alaskan	Fixed, mobile except aero. (10)	15300-16400	Fixed, aero. fixed	Fixed
4890-4990	Government (8)	Aeronautical mobile (8)	16400-16555	Coastal, marine relay, ship, mobile press, aeronautical	Mobile
4990-5010	Government	Std. freq. broadcast on 5000 kc	16555-16565	Mobile (calling freq. 16560) (12)	Mobile (calling freq. 16560 kc) (12)
5010-5300	Fixed, aero. fixed	Fixed	16565-17100	Coastal, marine relay, ship, mobile press, aero.	Mobile
5300-5500	Fixed, aero. fixed, Alaskan	(a) Fixed, and mobile except aero. & maritime	17100-17600	Fixed, aero. fixed	Fixed
5500-5800	Aeronautical mobile (6)	Aeronautical mobile (6)	17600-17700	Fixed, aero. fixed, coastal telephone	Fixed, maritime mobile (10)
5800-6000	Fixed, aero. fixed	Fixed	17700-17900	International broadcast	International broadcast
6000-6200	International broadcast	International broadcast	17900-19985	Fixed, aero. fixed	Fixed
6200-6300	Coastal, marine relay, ship	Maritime mobile	19985-20015	Government	Standard freq. broadcast on 20000 kc
			20015-20500	Fixed, aero. fixed	Fixed
			20500-21000	Fixed, aero. fixed, coastal, marine relay, ship, mobile press, aeronautical	Fixed, mobile
			21000-21500	Amateur	Amateur
			21500-21700	International broadcast	International broadcast
			21700-24985	Fixed, aero. fixed	Fixed
			24985-25015	Government	Standard freq. broadcast on 25000 kc

(1) Aero. fixed shall have priority in the polar regions.  
 (2) Not open to public correspondence in the American region.  
 (3) Lowest and highest assignable frequencies are 540 and 1600 kc.  
 (4) 500 watts peak power limit for both fixed and mobile.  
 (5) Calling limited to telegraphy.  
 (6) Frequencies within these bands are reserved primarily for long-distance overseas air routes and only where the use of frequencies above 30 Mc is impracticable.

(7) Frequencies within this band are reserved for fixed circuits associated primarily with long-distance overseas air routes where other facilities are not available or are impracticable.  
 (8) Not available to civil aviation.  
 (9) Power limited to 200 watts peak.  
 (10) Maritime mobile limited to coastal telephone stations.  
 (11) 13660 kc is for industrial, scientific and medical. All emissions must be kept within the band 13652.5 to 13667.5 kc.  
 (12) Limited to telegraphy.

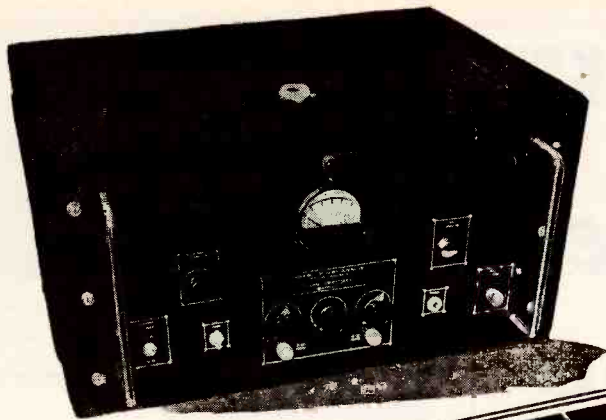

### UHF HARMONIC FREQUENCY GENERATOR

PROVIDES output voltages which are multiples of 10 or 40 megacycles with CRYSTAL-CONTROLLED accuracy.

RECOMMENDED FOR: the calibration of receivers, wavemeters, or using internal beat detector for calibration of oscillators and signal generators.

WRITE FOR FULL DETAILS



*Lavoie Laboratories*  
RADIO ENGINEERS AND MANUFACTURERS  
MORGANVILLE, N. J.

## An Open Letter on your War or Post-War UHF Problems...

This letter is your invitation to consult with us on your present or reconversion problems in the UHF field.

Your immediate plans may consist simply of ideas on which you require technical advice - or you may need help in re-design or ways and means to lower production costs.

Regardless of your particular requirements, our specialized knowledge of UHF, plus a plant especially equipped for UHF production, should be invaluable in accomplishing your objective quickly, accurately and economically.

There is no cost or obligation involved in talking it over. Your inquiries will have our prompt and careful attention.

Very truly yours,

LAVOIE LABORATORIES

### UHF PRECISION FREQUENCY METER

Completely portable Accuracy 0.1%  
Battery or AC-Operated

Models available from 100 to 1500 megacycles with 2 to 1 frequency coverage on each model. Available only on high priority.





# NO "COMEBACKS"

when you use

# Glaser

## SOLDER PRODUCTS

Glaser Rosin Core Solders exceed Government specifications in purity, and are guaranteed to meet A.S.T.M. Class A specifications for solder.

**Y**OU can't take chances with soldering connections in the electronic and radio fields. *The bonding must be permanent!*

When you use Glaser Solders and Fluxes you are protected against "comebacks." Glaser soldering jobs *stay put!*

Glaser Solder Products and Fluxes are dependable because they are produced under rigid scientific control. Their quality never varies, insuring uniform performance. Glaser Products have served American industries for over 23 years. Our engineering Department knows what each must be—for every purpose—to perform perfectly under severest service conditions.

The outstanding quality of Glaser Products is well known in the electronic and radio industries. Widely used in the manufacture of delicate electrical equipment for the Signal Corps and other branches of the Military Service.



Write for literature

GLASER LEAD CO., INC., 31 WYCKOFF AVE., BROOKLYN 27, N. Y.

IF YOU'RE PUZZLED about electronic controls or assemblies for your postwar plans...

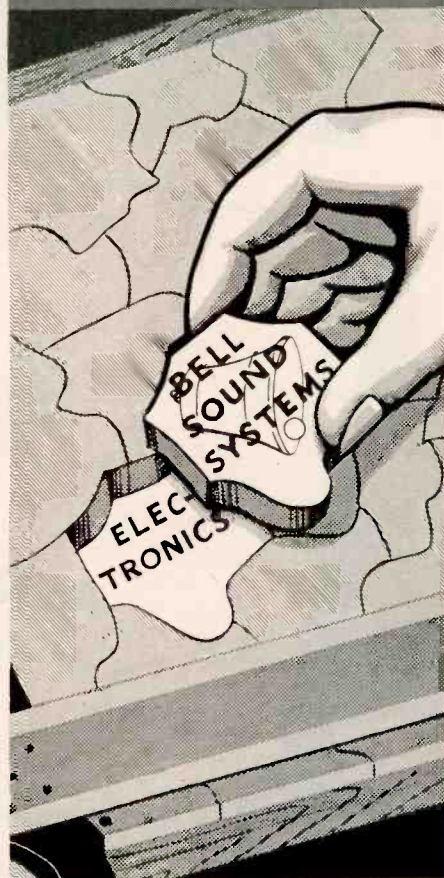

**BELL may have the answer!**

use of electronic controls or assemblies—as a part of your product, or to meet a production problem—we may have the answer. Our wide experience in designing and building electronic equipment, carried right through from early electronic developments to the latest types of vital electronic devices, qualifies us to serve you. Your inquiry will not obligate you in any way.



**BELL SOUND SYSTEMS, INC.**  
1189 Essex Avenue, Columbus 3, Ohio  
Export Office: 4900 Euclid Ave., Cleveland 3, Ohio

## ACCURATE INSTRUMENTS for PRECISION TIMING



Table model electric stop clock with a-c clutch and toggle switch

The Stoelting table model electric stop clock is an accurate timer for a wide variety of industrial and laboratory tests . . . such as measuring start-to-stop intervals of relays and instruments, and for checking sequence operations.

Timer with a-c clutch has toggle switch for manually starting the pointer. Timer with d-c clutch has binding posts only for attaching d-c control circuit for starting and stopping the pointer. Both timers have a-c clock motors, and pointers are reset with knob.

The Stoelting electric timer and impulse counter is an accurate, dual-purpose instrument for counting individual electric impulses or for use as a chronoscope.

When used as timer, 11-16 v current is taken from step-down transformer. When used as counter, direct current only is used. Counter capacity—7,200 impulses.

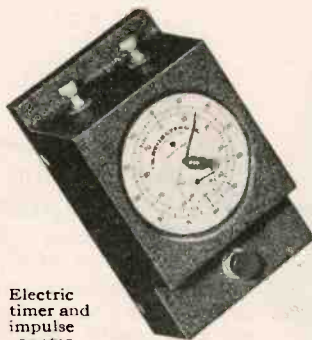

Electric timer and impulse counter



**FREE ILLUSTRATED BULLETIN**

Send for Stoelting Timer Bulletin No. 1100. Includes illustrations, wiring diagrams, technical data, and complete information on stop clocks, chronoscopes, impulse counters, stop watch controllers, and X-ray timers.

**C. H. STOELTING CO.**

INDUSTRIAL DIVISION

424-A N. HOMAN AVE. • CHICAGO 24, ILLINOIS

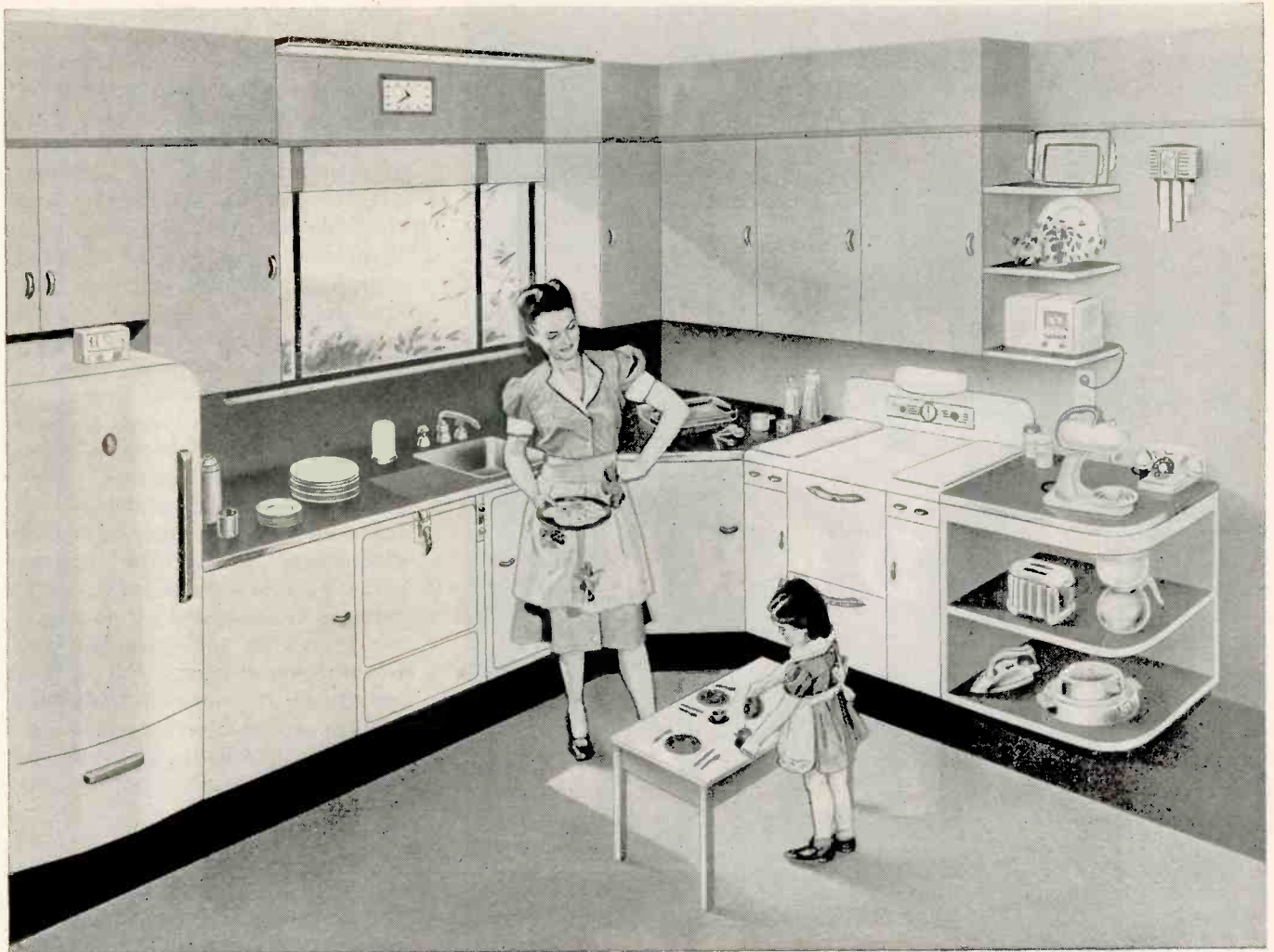

## *The Plastics Kitchen of Tomorrow*

● From the floor to the ceiling, your next kitchen truly will represent the modern age of plastics. There'll be Plaskon Molded Color carrying a range of gay tones throughout the room. Plastic handles, knobs, closures, housings, tableware, electrical equipment and parts, lighting reflectors, telephones—even garment buttons and shoe ornaments—will be of sparkling molded Plaskon. Service requirements of durability, non-conductivity, sanitation and ease of cleaning are adequately filled by Plaskon in these applications.

The kitchen will be lined with handsome, low-cost, prefabricated cabinets of plywood, made with Plaskon Resin Glue. Washable resin-treated paper finishes of attractive colors, and almost impossible to mar or scar, will be bonded to the exterior surfaces with this powerful glue. In any application it is permanent and highly waterproof; unaffected by heat, cold, bacteria or fungi; and its tenacious grip cannot be weakened or broken.

Tough linoleum, treated with Plaskon Coating Resin, will provide a colorful, durable covering for floors, cabinet and shelf tops, and splash

surfaces. Special Plaskon resins will assure finishes to meet particular needs for many kitchen surfaces; and will be used for the development of other new utility applications in the kitchen and throughout the house.

The plastics kitchen of tomorrow, with its widespread use of Plaskon materials, is but one indication of the versatility of these modern products of industrial research. Plaskon resins offer you exceptional manufacturing and sales advantages in product development. Our experienced field men will gladly help develop your plans.

**PLASKON DIVISION**  
 LIBBEY • OWENS • FORD GLASS COMPANY  
 2136 Sylvan Ave. • Toledo 6, Ohio  
 Canadian Agent: Canadian Industries, Ltd., Montreal, P. Q.

# PLASKON

TRADE MARK REGISTERED

★ ★ MATERIALS ★ ★

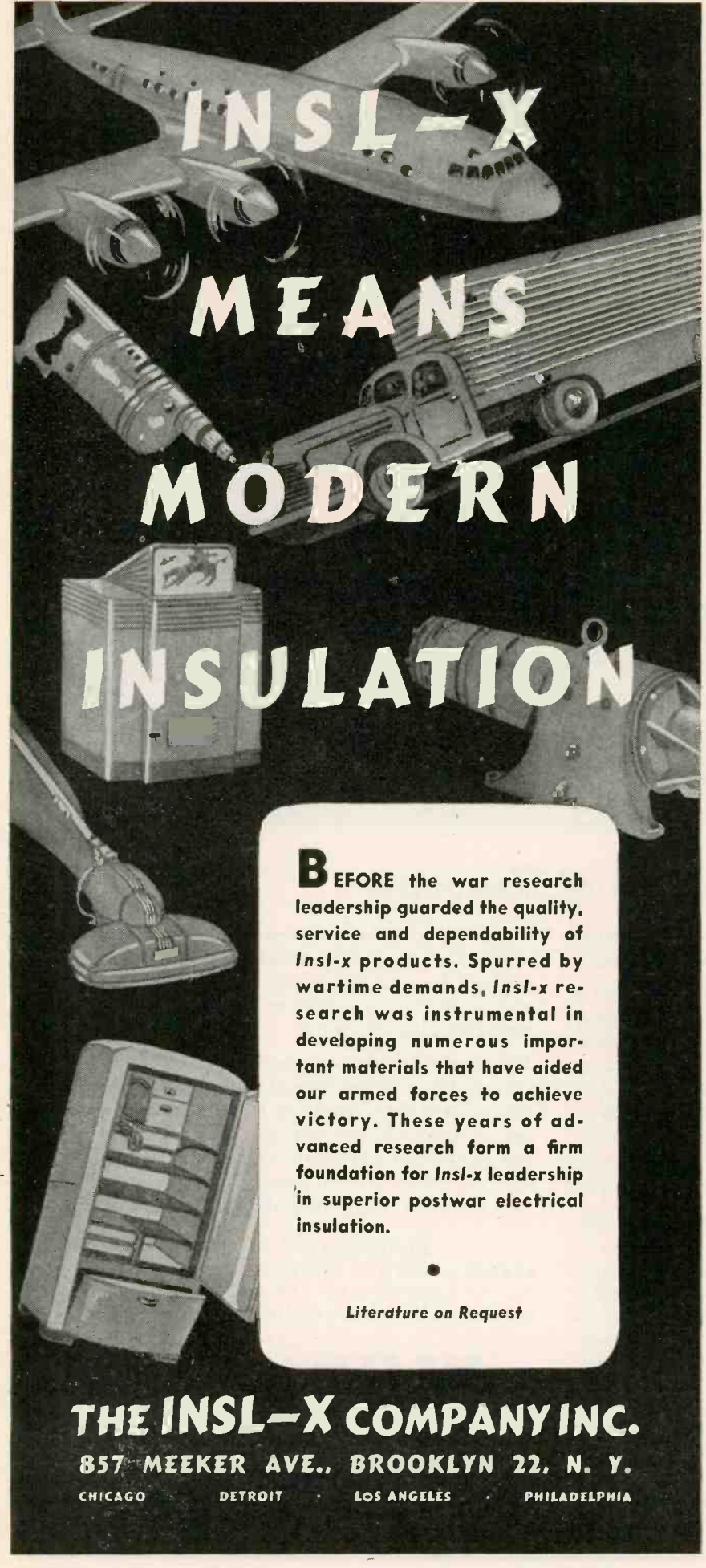

# INSL-X MEANS MODERN INSULATION

**B**EFORE the war research leadership guarded the quality, service and dependability of *Insl-x* products. Spurred by wartime demands, *Insl-x* research was instrumental in developing numerous important materials that have aided our armed forces to achieve victory. These years of advanced research form a firm foundation for *Insl-x* leadership in superior postwar electrical insulation.

Literature on Request

**THE INSL-X COMPANY INC.**

857 MEEKER AVE., BROOKLYN 22, N. Y.

CHICAGO

DETROIT

LOS ANGELES

PHILADELPHIA

times of disaster, such as floods, earthquakes, hurricanes, etc.; increased emphasis on the requirements of aviation radio communications, including navigational aids, after the war; and establishment of a greater number of SOS frequencies for use by aircraft and small surface craft in distress and to provide more reliable coverage over long distances on radio distress calls.

As the commission points out, the radio spectrum below 25,000 kilocycles is so overcrowded that it has been impossible to meet the requirements of all radio services operating in these ranges. However, the FCC has attempted to make an equitable distribution of frequencies among the various services. Wherever possible, radio services are expected to move into the very high and ultrahigh portions of the spectrum and to take advantage of improved equipment and transmission techniques to enable them to make the most efficient use of the spectrum space available to them.

No decision has yet been made as to the number of new stations the new 540-kc broadcast band channel will accommodate or as to whether the channel will be used by local, regional or clear-channel broadcast stations. It is believed that possible interference with auto alarms on the 500-kc distress frequency can be solved by assigning 540 kc for use at appropriate geographical locations and by limiting the intensity of the signals in coastal areas. (There are now 928 standard stations broadcasting and 23 others under construction. The FCC has in its pending files approximately 180 applications to build new standard stations when manpower and materials again become available for civilian radio construction.) About 54 percent of the present receiving sets will be able to receive programs from stations operating on the 540-kc frequency. However, the channel including 540 kc is now used by the government and it is not known how soon it can be made available to broadcasters.

Six bands of frequencies, involving a total of 120 channels below 25,000 kc, are set aside for direct international broadcasting on a worldwide basis.

The bands 3500 to 4000, 7000 to

PERFECTION IS OUR **ONLY** AIM!



REMEMBER AND BUY IN THE 7TH!



Japan knows the magical efficiency of Detrola-built mine detectors and other electronic devices. With the eclipse of the Rising Sun, Detrola will manufacture distinctive radio and television receivers... sturdy record changers... all of unparalleled value.

## DETROLA RADIO

DIVISION OF INTERNATIONAL DETROLA CORPORATION  
DETROIT 9, MICHIGAN

# "ALNICO" PERMANENT MAGNETS

Specializing in the production of highest quality Alnico Magnets in all grades including new triple strength No. 5.

Production material checked to assure highest uniform quality of product.

Castings made to customer's special order on the basis of sketches or blueprints furnished.

Information and suggestions furnished on request.

## GENERAL MAGNETIC

C O R P O R A T I O N

MANUFACTURERS OF HIGH COERCIVE MAGNETIC ALLOYS

2126 E. Fort Street

Detroit 7, Michigan

### COMING EVENTS CAST THEIR SHADOWS

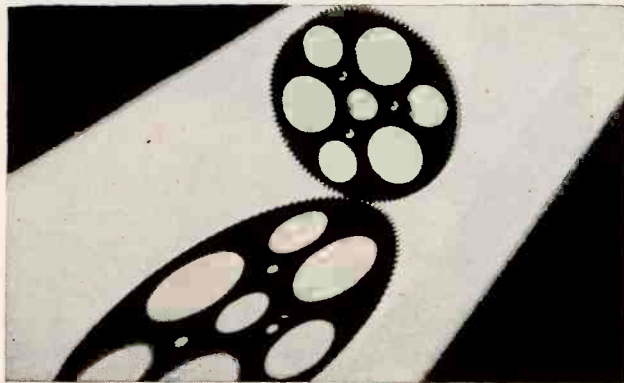

Greater "know-how" in gear cutting methods has resulted in finer accuracy and finish without additional cost. As a result, gear teeth stand up longer and roll more quietly. These will be important factors in the gear design of your future products, making them more dependable and attractive.

Our services and experience will help you solve production problems on small or medium size spur, helical and rack gears, worms, splines, sprockets and ground threads. Write for quotation on your specifications. No obligation of course.



*Beaver Gear Works Inc.*

1025 PARMELE STREET, ROCKFORD, ILLINOIS

# QUALITY PLASTIC DIALS

★ PRECISION-MADE  
TO YOUR  
EXACT SPECIFICATIONS

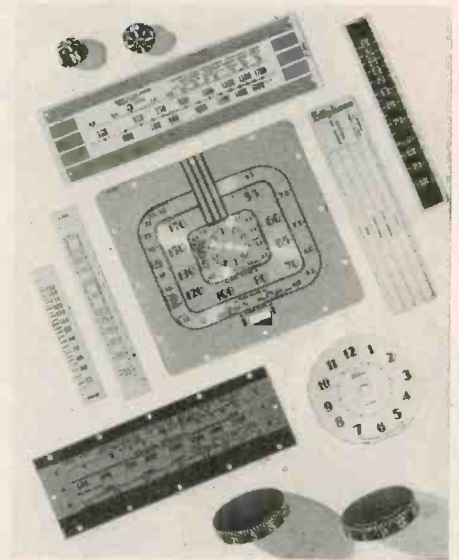

Where your plastic dial requirements demand precision fabrication, it will pay you to call on the experience and skill of Sillcocks-Miller specialists. They can help you in four ways:

1. In working out your own ideas.
2. In developing new ideas for you.
3. In advising you on the most practical and economical methods of fabrication.
4. In selecting the right plastics for your requirements.

Remember, it costs you less to pay a little more for Sillcocks - Miller quality.

Write for Illustrated Booklet

**THE SILLCOCKS-MILLER CO.**

10 West Parker Avenue, Maplewood, N. J.

Mailing Address: South Orange, N. J.

*Specialists in High Quality, Precision-Made Plastics Fabricated for Commercial, Technical and Industrial Requirements*



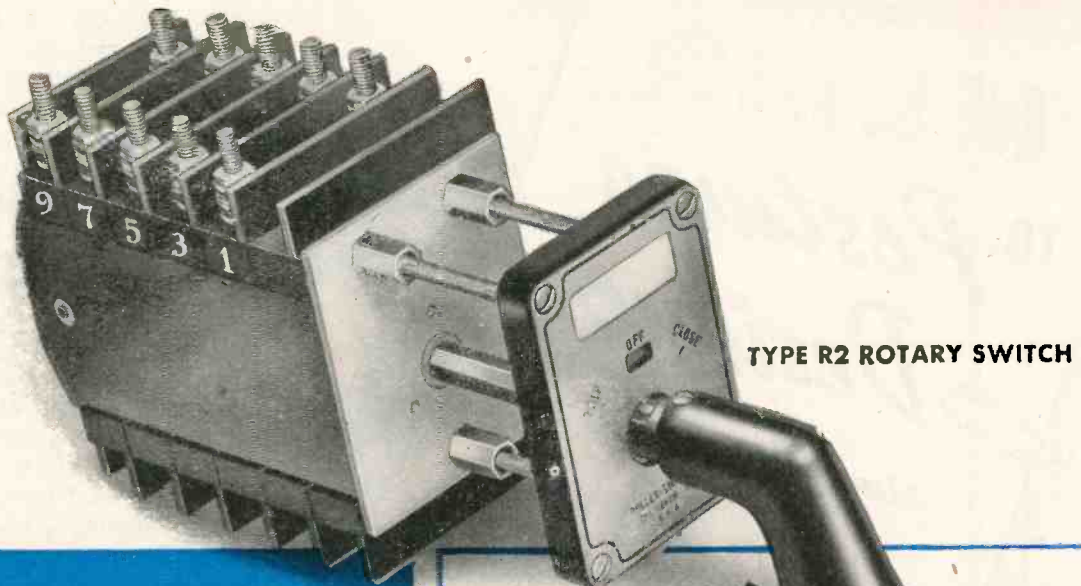

TYPE R2 ROTARY SWITCH

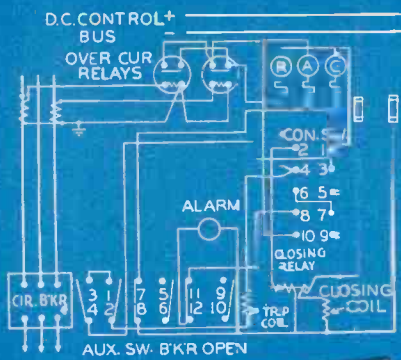

ONE OF **88**  
**CIRCUIT COMBINATIONS**  
*to meet your needs*

**ROTARY SWITCH APPLICATIONS**

Ammeter	4
A. C. Voltmeter	10
D. C. Voltmeter	9
Frequency Meter	1
Wattmeter	2
Power Factor Meter	2
Temperature Indicator	2
Synchronizing	8

**CONTROL SWITCH**

Circuit Breaker Control	6
Motor Control	1
Governor Speed and Rheostat Control	2

**TRANSFER SWITCH**

Single Pole	12
Two Pole	14
Three Pole	5
Four Pole	3
Five Pole	1
Six Pole	3

• The 88 standard circuit combinations of Roller-Smith Type R2 rotary switch cover most applications for an instrument switch, control switch or transfer switch.

The switch body is of unit construction suited to switch-board mounting. Standard switchboard terminals simplify connections. Silver to silver contacts have continuous current carrying capacity of 10 amperes. Bakelite insulating barriers between poles isolate terminals. Removable bakelite side covers protect against dust and permit easy access for inspection. The number of units runs from one to nine. Each unit may be a single break switch with two circuits or a double break switch with one unit. For complete information on this versatile switch, write for your copy of Catalog 7140. Address Dept. EL-1.

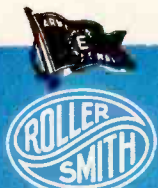

Sales Representatives  
 In all Principal Cities

**ROLLER-SMITH BETHLEHEM, PENNA.**

Canadian Plant: ROLLER-SMITH MARSLAND, LTD., Kitchener, Ontario

STANDARD AND PRECISION ELECTRICAL INSTRUMENTS • AIRCRAFT INSTRUMENTS • SWITCHGEAR •  
 AIR AND OIL CIRCUIT BREAKERS • ROTARY SWITCHES • RELAYS • PRECISION BALANCES

# MEMO

TO: *Postwar  
Designers*

*simplify design and  
reduce costs with  
Walker-Turner  
Flexible Shafting!*

Reduced production costs is the key to the lower-prices, increased-sales-volume, more-jobs combination needed for post-war prosperity. Walker-Turner Flexible Shafting offers a proven way to bring about this reduction—in products involving remote control or the transmission of light power loads!

By substituting Walker-Turner Flexible Shafting for complicated gear systems in these applications, design is substantially simplified. The product is lighter, more compact. Less material is required. Costly machining is eliminated. Shipping and storage costs go down. Write today and let us put our years of flexible shafting experience to work for you!

**WALKER - TURNER CO., INC.**  
Plainfield New Jersey

7300, and 14,000 to 14,400 kc are being retained for amateur use. The 300-kc wide band between 1750 and 2050 kc is being deleted. In lieu thereof, the Commission is making provision for amateurs to operate a disaster communications network in the band 1605 to 1800 kc. The exact width of this frequency band and its location within the range 1605 to 1800 kc is undetermined at this time. In addition, the Commission proposes to assign a 500-kc wide band between 21,000 and 21,500 kc to the amateurs.

Six channels are included for use by the National Bureau of Standards to provide a highly accurate standard for the measurement of frequencies, and for the transmission of time signals, to be used by scientists, observatories and radio station operators throughout the world to calibrate their equipment.

The Commission is not making specific proposals regarding channel widths for stations in the fixed public services at this time. However, in view of the urgent requirement for conservation of frequencies, the Commission will expect licensees to avail themselves of the latest technical improvements looking toward early realization of the use of 2.5 kc, or less, per telegraph communication channel and not more than 5 kc per telephone or facsimile channel. This objective is believed to be reasonable since it is expected that, of necessity, use of such technical improvements will be adopted generally on a worldwide basis.

#### *Total Number of Channels*

A comparison between the total number of channels requested, the total currently assigned and the total proposed, cannot be made since (1) no decision has been made as to channel widths; (2) the number of channels to be used by aeronautical and government fixed services cannot be determined at this time; (3) the assignments at the time of the hearing included shared frequencies which are regularly assigned to other services such as coastal harbor and coastal telephone; and (4) the channel requirements of other nations throughout the world are not known.

For the fixed public services, the Commission is of the opinion that



## FLEXIBLE SHAFTING

FOR REMOTE CONTROL AND POWER TRANSMISSION



LABORATORY INSTRUMENTS FOR SPEED AND ACCURACY

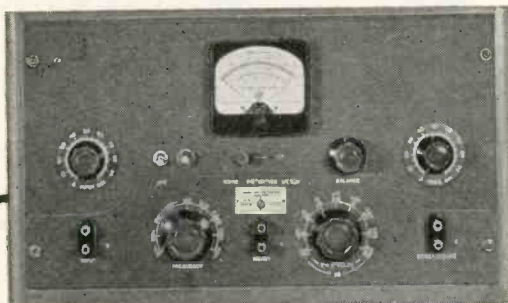

**This instrument separates harmonics from a desired frequency**

By eliminating the fundamental frequency, this instrument permits accurate measurement of noise, distortion and the harmonics of the wave. At balance its fundamental circuit has almost infinite attenuation at a single frequency and other frequencies are passed with little or no attenuation.

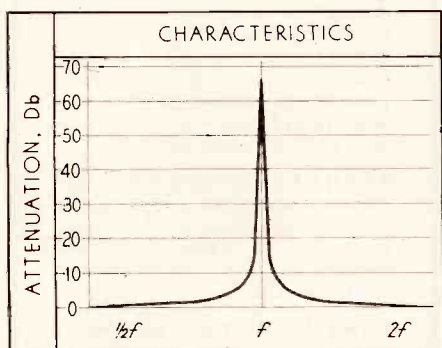

As shown in the chart: the attenuation at the 2nd harmonic (2F) would be in the order of 1/2 db while at the resonant frequency it would be infinite—from 60 to 70 db in practical circuits making it possible to measure distortions as low as 0.1%.

The *-hp-* Model 325B Noise and Distortion Analyzer is really a combination of three separate elements: a frequency elimination circuit, a

stabilized 20 db amplifier and a vacuum tube voltmeter, any one of which may be used individually. The amplifier employs inverse feedback and is very stable . . . accuracy is independent of line voltage and tube characteristics. Because the input is to the grid of the amplifier and is equivalent to 200,000 ohms, it will not load down the circuit being measured. The sensitivity of the vacuum tube voltmeter in combination with the amplifier is such that hum may be measured directly and voltage measured as low as .0005.

The *-hp-* Model 325B covers the audio frequency spectrum, supplying frequencies of 30 cps, 50 cps, 100 cps, 400 cps, 1000 cps, 5000 cps, 7500 cps, 10,000 cps and 15,000 cps within  $\pm 5\%$ . These frequencies cover FCC recommendations for checking FM as well as AM broadcast. The meter scale is calibrated in volts and in db.

The *-hp-* Model 325B in combination with *-hp-* 200 series Audio Oscillators provides equipment to make most laboratory AF measurements including distortion, power, gain and frequency response. Write for complete information now.

**OTHER *-hp-* INSTRUMENTS**



**Distortion Analyzer**

The Model 320A consists of two fundamental elimination circuits, 400 cps and 5000 cps, together with a calibrated attenuator reading in decibels.



**Distortion Analyzer**

The Model 320B consists of six fundamental elimination circuits, 50, 100, 400, 1000, 5000 and 7500 cps, together with a calibrated attenuator reading in decibels.



**Harmonic Wave Analyzer**

The Model 300A consists of a highly selective amplifier which measures the individual components of a complex wave.



**Attenuator and Voltage Divider**

The Model 350A is a bridged-T attenuator consisting of one 100 db attenuator with 10 db steps and a 10 db attenuator having 1 db steps.

**HEWLETT-PACKARD COMPANY**

BOX 1045A • STATION A • PALO ALTO, CALIFORNIA

- Audio-Frequency Oscillators
- Signal Generators
- Vacuum Tube Voltmeters
- Noise and Distortion Analyzers
- Wave Analyzers
- Frequency Meters
- Square Wave Generators
- Frequency Standards
- Attenuators
- Electronic Tachometers

*Look at this!*

**THE LARGEST  
FABRICATED PLASTIC  
PART OF ITS KIND!**

This coil form is one of a production lot fabricated in our shop; drilled with more than one hundred holes, all close tolerance as to size and location.

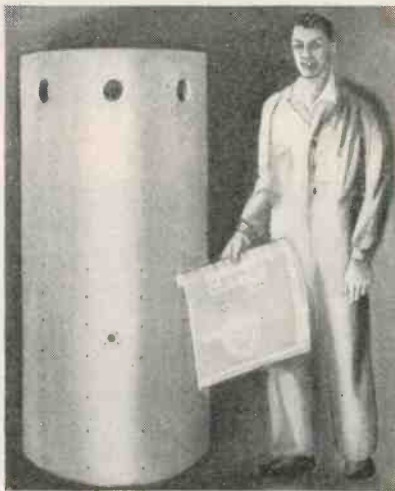

Of importance to you is our ability to furnish prompt delivery. If you are faced with a tough fabrication problem, or the necessity of fast service, a consultation with one of our organization may help you to meet your own delivery dates.

We carry a large stock of phenolic laminated sheet material and can give you prompt service on specially fabricated parts or on sheets, rods and tubes.

**ELECTRICAL INSULATION CO., INC.**

12 VESTRY ST.,

NEW YORK 13, N. Y.

**FABRICATED PHENOLIC PARTS . . . SHEETS, RODS, TUBES**

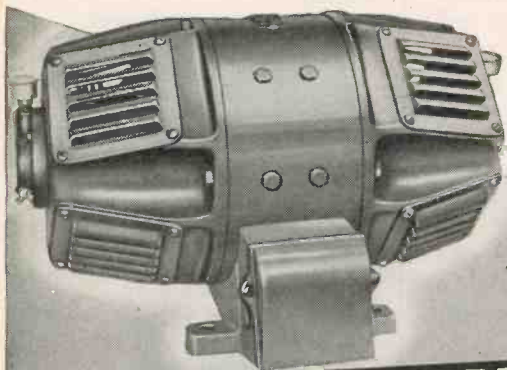

**D.C. to A.C.  
by JANETTE**

UP  
TO 3.2  
K.V.A.

**D.C. to A.C. CONVERTERS**

**Electronic and Gaseous Tube Devices** can be operated from direct current power by means of a rugged Janette converter. When used with sound devices, specially designed filters discriminating enough to filter out unwanted noises and to minimize conducted radio noise voltage, can be furnished.

For nearly a quarter of a century Janette converters have given dependable service under varied climatic conditions in all parts of the world.

If you have a D.C. to A.C. requirement and want a reliable, high quality converter you can safely specify a Janette.



**Janette**

Ask for  
Bulletin  
13-25

Janette Manufacturing Co. 556 W. Monroe St. Chicago 6, Ill.



**PROTECTOSEAL**

GUARDS  
AGAINST  
FIRE  
HAZARD



**BENCH  
CAN**

**FOR CLEANING  
SMALL PARTS**

**IMPROVES EFFICIENCY.** Parts to be cleaned are placed on the perforated-metal dasher, which is then depressed so cleaning liquid filters through and covers parts. Dasher is spring-mounted and returns above liquid level when released. Parts drain on dasher and can be placed on open cover to dry. Cover when open forms a horizontal tray with handle as support.

**REDUCES EVAPORATION.** Through minimum exposure and agitation of cleaning fluid, evaporation from open can is reduced to a minimum. When cover is closed, can is vapor-tight.

**LOWERS FIRE HAZARD.** Double perforated-metal dasher is an effective fire baffle. Ignition of vapor above dasher is prevented from reaching liquid in can. Fire burns out harmlessly or can be snuffed out quickly by closing cover.

**APPROVED.** Protectoseal BENCH CANS are approved by Associated Factory Mutuals. Made in 4 sizes from 3-pint to 3-gallon capacity. Write today for complete data on the PROTECTOSEAL line of Fire Baffle Fill and Vent Fittings, Safety Cans, Plunger Cans, Wash Tanks.

PROTECTOSEAL COMPANY  
1948 SO. WESTERN AVE.  
CHICAGO 8, ILLINOIS

**PROTECTOSEAL**



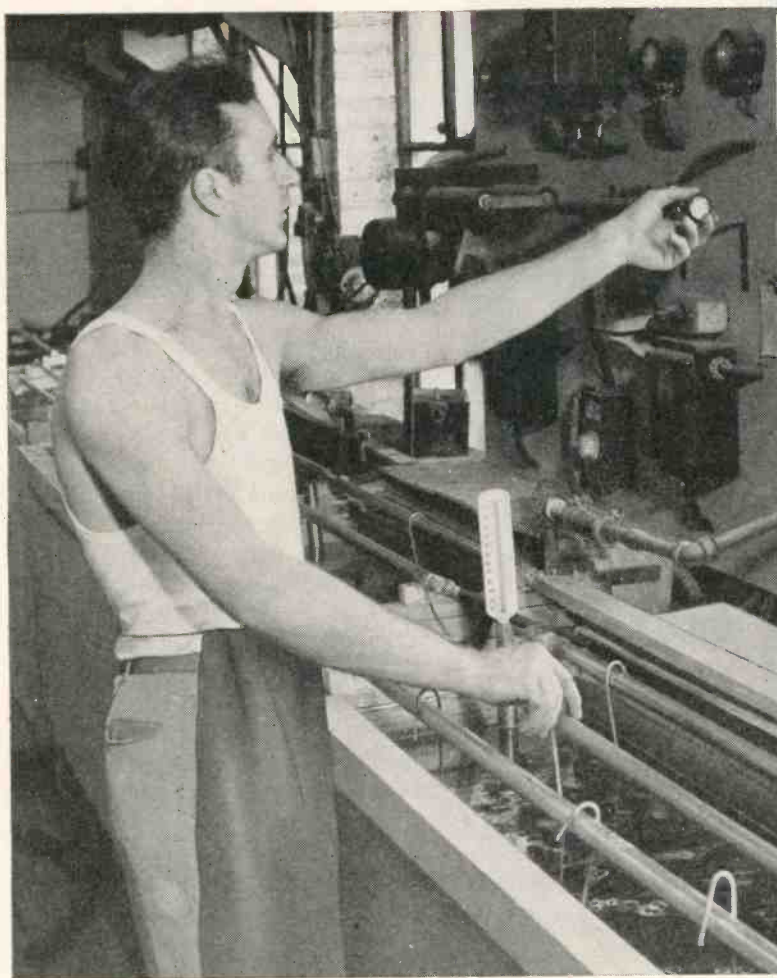

## UNDER COMPLETE CONTROL

In the laboratory, in processing, in inspection, gold and silver plating at DICO are under complete control, from the original specifications to the final product. No higher adherence to the most rigorous standards of plating precision and performance is available anywhere. At DICO, your requirements in plating can be accurately, promptly, and efficiently met.

There are also other facilities at DICO that will be of the utmost service to manufacturers during postwar readjustment. Furthermore, nothing comparable to them for expert and conscientious craftsmanship will exist in sufficient volume to fill the postwar demand. Therefore, the time to acquaint yourself with DICO, for your advantage in the near future, is now.

**PRODUCT ENGINEERING, GOLD AND SILVER PLATING, MACHINING,  
CASTING, SOLDERING, ASSEMBLING AND FINISHING**



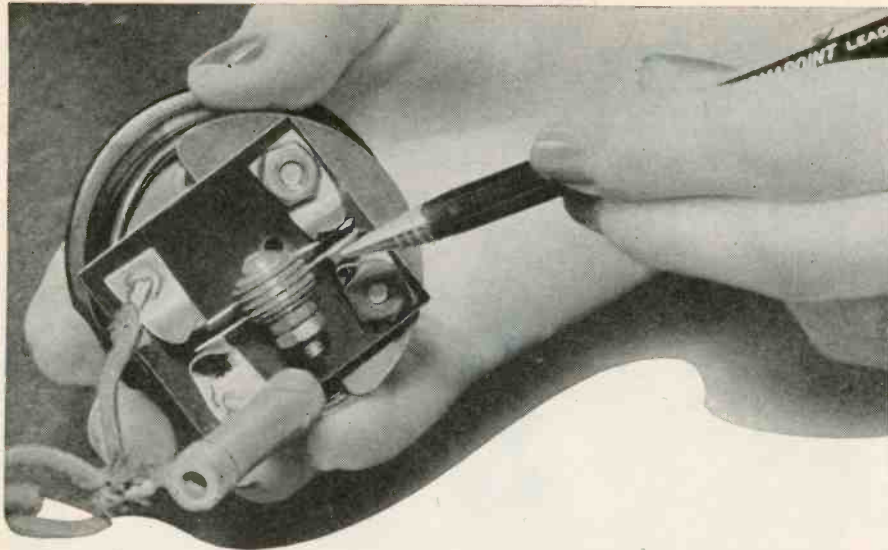

still delivering after  
**88,000 HOURS**  
**96,000** Continuous Service

In July, 1944, we told you the story of this "defective" Conant type M rectifier which we kept in continuous operation in an effort to discover the "defect" a customer had claimed.

This same "defective" Conant rectifier is still operating 24 hours every day after more than eleven years. And, after 96,000 hours, it still delivers its original output.

Since this "time-honored veteran" was built in 1934, Conant rectifiers have been continually improved to make them more dependable. So, wherever accuracy and dependability are important, you can Count On Conant.

Write today for details about Conant's new rectifier assembly that eliminates temperature variations.

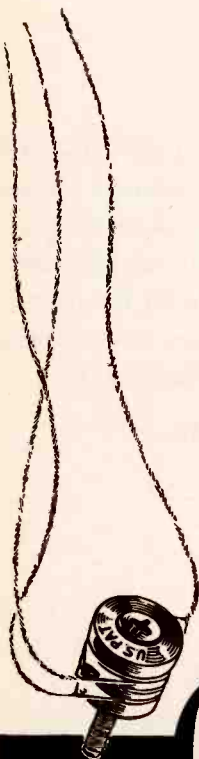

*Instrument Rectifiers*

**ELECTRICAL LABORATORIES**

6500 O STREET, LINCOLN 5, NEBRASKA, U. S. A.

20 Vesey St., New York 7, New York  
85 E. Gay St., Columbus, Ohio  
600 S. Michigan Ave., Chicago 5, Ill.  
1215 Harmon Pl., Minneapolis 3, Minn.

2017 Grand Ave., Kansas City 8, Mo.  
1212 Camp St., Dallas 2, Texas  
378 Boulevard N. E., Atlanta, Ga.  
4018 Greer Ave., St. Louis, Mo.

1526 Ivy St., Denver, Colo.  
4214 Country Club Dr., Long Beach 7, Cal.  
Export Div., 89 Broad St., N. Y. 4, N. Y.  
50 Yarmouth Rd., Toronto, Canada

only through a properly organized system of assigning frequencies, by geographical zones throughout the world, will it be possible to accommodate the post-war requirements of all nations. Under such a zoning plan, a given frequency may be employed in as many as three or more different locations in the world during a period of 24 hours. Such a plan will have the practical effect of increasing the number of channels available to each nation, a consideration of the highest importance when it is realized that many countries will use radio transmission in a post-war era to a far greater extent than they have in the past. The Commission will exert every effort to make such an organized system of assigning frequencies possible.

The provision of shipboard radio direction-finding facilities and a comprehensive maritime beacon system has largely obviated the necessity for shore-based direction finders and has resulted in a decline in their use. For these reasons, it is not proposed to continue the allocation of 375 kc for shore-based radio direction-finding systems.

It is proposed, in view of the improvements in ship station receiver selectivity and transmitter frequency stability, to reduce the guard bands for the 500-kc international distress and calling frequency from 15 to 10 kilocycles.

It is proposed to designate the frequencies 2070, 4140, and 8280 kilocycles as additional international distress and calling frequencies (telegraphy) to facilitate communication between stations engaging in air-sea rescue operations.

#### *Aeronautical Outlook*

The requests of civil aviation for radio-frequency bands below 25 megacycles can not be granted in full without seriously affecting the minimum requirements of other services. It is evident that means must be found by which the spectrum space requested can be reduced. This may be accomplished in only one way, namely, by obtaining the most efficient use of the spectrum available to that service. This may be accomplished in several ways: (1) Employ the narrowest band of emission that will satisfactorily transmit the desired intelligence most economically from



PLASTIC PARTS  
ARE FROM GENERAL  
INDUSTRIES

WE'VE SPECIFIED  
THEIR MOTORS, TOO

YOU'LL be in good company when you specify General Industries molded plastic parts or low-torque electric drives, or both. From one plant, under one management, we supply both these products to the most rigid specifications.

## YOU CAN SPECIFY **BOTH** FROM GENERAL INDUSTRIES



In our molded plastics division, we have the know-how to do large or small jobs, simple or intricate, in any quantities. While we don't attempt to design or redesign your parts, our skilled and co-operative team of engineers, mold makers and machine operators frequently make suggestions for better, faster or lower cost moldings that will meet or beat your specifications.



You'll find similar ability in our small motors division. For years, we've built *Smooth Power* drives for our own lines of recorders, record-changers and turntables, and for electric and electronic products of leading manufacturers. If one of our many standard motors or drive assemblies won't meet your specifications, we'll design and build one that will, exactly.

So, if you're specifying molded plastics or small motors, we'd like to work with you. Definite commitments must wait until the end of our military work is in sight, but a start now may help you get to the markets quicker with your postwar products. It will be appreciated if you will address the specific division . . . *molded plastics or small motors.*

THE  
**GI** GENERAL  
INDUSTRIES  
COMPANY  
ELYRIA, OHIO





**For 110 volt Circuits  
or 220 if Desired**



**SOCKET AND JEWEL LIGHT ASSEMBLIES**

**DRAKE MANUFACTURING CO.**

1713 WEST HUBBARD ST., CHICAGO 22, U.S.A.

**T**HE New Drake No. 75AP is designed for 110 volt circuits. However, the Resistor we can supply readily adapts it for use with 220 volt circuits if desired. This sturdy, rigid, Jewel Light Assembly never needs replacement. Every detail of construction is designed for long, dependable service under the most severe conditions. This is an underwriter's approved unit, for use with Mazda S6, 110 volt, 6 watt, candelabra, screw base lamp. We can ship the 75AP complete, with lamp installed, if so specified. The lamps are easily removed with our S6 Lamp Remover—a real convenience when large numbers of these units must be serviced. You can depend upon DRAKE for any type of standard or custom built unit required. Do you have our catalog handy?

**New O-T CABLE CLAMP**  
*Does a better job, faster..*

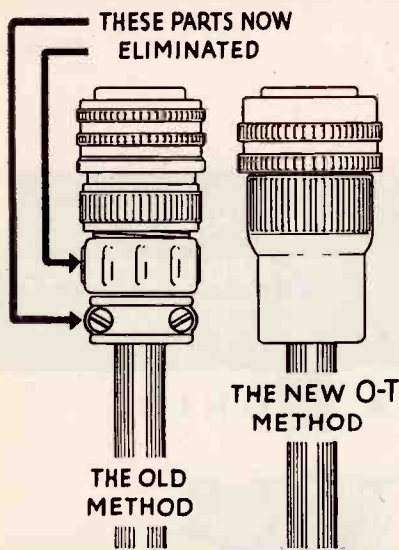

Assembly time and number of parts cut to a minimum by new simple compression type.

- ★ Waterproofs the assembly without extra parts.
- ★ Eliminates pinching or rupturing cable coverings.
- ★ Positive hold prevents stress on soldered connections.
- ★ Easily adapted to cable varying in size and shape.
- ★ Faster assembly—conserves manpower.
- ★ Ideal for all wiring systems—single or multiple conductors with flexible or rigid coverings.

Learn how this cable clamp can improve your assembly time and give you a better job. Send us your "specs" today!

**OXFORD-TARTAK RADIO CORP.**

3911 S. MICHIGAN AVE., CHICAGO 15, ILL.

**10,000  
PARTS**

Ten thousand different  
radio and electronic parts immediately  
available on priorities

**SERVICE**

Trained expeditors select  
and ship same day your order  
is received

**EXPERIENCE**

Known since 1922 as reliable  
jobbers, wholesalers and manufacturers of  
radio and electronic equipment

**Radio Wire  
Television Inc.**

100 Sixth Ave. Dept. E-7 New York 13, N. Y.

Boston, Mass. Newark, N. J.

World's largest Radio Supply House

Originators and  
Peacetime Marketers  
of the celebrated

**Lafayette Radio**

Write today for our bargain  
flyers and special bulletins



**PARTS FABRICATED  
BY ROGERS**



**KAYPAR** fuel  
pump protector



**KAYGREY** radio  
dust cover



**KAYGREY** magneto  
insulator



**KAYGREY** formed  
insert



**DURO** motor  
slot cell



**DUROK** capacitor  
can liner



**BAYRU** packing  
list protector



**SHE'LL BE USING DUROK\*  
—ANOTHER ROGERS-BORD**

**F**ABRICATED PARTS used to insulate capacitors, loudspeakers, antenna systems and other radio components are now "in work" in Rogers' fabricating division. The radio industry has seen that it can advantageously use Rogers-Bord—and can have Rogers form, draw, punch, bend and shape these tough, high-dielectric materials. Rogers designs and produces the necessary dies in its own tool and die shop. The Rogers "you name it, we'll make it" slogan applies to special fabricating as well as to special fibrous and plastic materials. And it applies now.

To learn more, check and mail:

- Send me the ROGERS EXHIBIT BOX, containing fabricated parts and samples of Rogers-Bord.
- Have a Rogers representative bring samples and fabricated parts.
- We are enclosing blueprint for suggestions and quotation.

NAME AND TITLE \_\_\_\_\_

COMPANY \_\_\_\_\_

ADDRESS \_\_\_\_\_

**ROGERS CORPORATION**  
Formerly  
The Rogers Paper Manufacturing Co.  
107 Mill St. Manchester, Conn.

**\*DUROK ROGERS-BORD**

Purified, non-cotton, cellulose fibers have now been wet-laminated into a new high-strength, high-dielectric material with the lowest extractibles ever. Data on this electrical insulating surprise are contained in "This Is Durok" Write for it.



# MURDOCK RADIO PHONES

## War-tested for Dependability!



### UNIFORM PERFORMANCE—Always

Laboratory tests alone do not provide all the answers. From warfare conditions — on every fighting front — we at MURDOCK are learning many vital things about Radio Phones that will be of tremendous benefit in building still better equipment for a world at peace.

In war — in peace — MURDOCK RADIO PHONES embody the same traditional quality and dependability that have made MURDOCK a leader in radio hearing performance for 40 years.

When you specify MURDOCK for your headset, you are assured of supersensitive, bell-tone clearness built into a rugged, shock-proof unit. Solidly made throughout with no loose parts. Cushioned comfort and lightness make listening a pleasure.

#### SUB-CONTRACTS INVITED

Let us help you on Radio Phones and related parts on a sub-contract basis. Your assignment handled with care, speed, and skill.

*Write for Catalogue Today*

**WM. J. MURDOCK CO.**  
180 Carter St., Chelsea 50, Mass.

the standpoint of spectrum utilization; (2) Restrict air-ground-air communications and inter-aircraft communications to those pertaining exclusively to the necessities of air navigation and to emergencies involving the safety of life and property; (3) Restrict operating power to the minimum required for satisfactory communications in order to permit duplication of frequencies with a minimum geographical separation; (4) Consolidate all international radio communication facilities under one operating agency; (5) Assign frequencies on an area basis instead of a route basis; (6) Employ the very high frequency spectrum for all communication with aircraft flying over land, and restrict frequencies below 25 megacycles to communication with aircraft flying international overseas routes only; (7) Employ radio only where other satisfactory means of communication cannot be utilized.

Bands for aids to air navigation are being assigned for government use substantially in compliance with the request of the RTPB. The one slight change made is that where RTPB requested 200 to 285 kilocycles, the allocation is 200 to 280 kilocycles. In addition, the band 1800-2000 kilocycles is proposed for navigation aids although not requested by RTPB.

### Alien Patents

PATENTS FORMERLY owned by aliens and seized by the United States government for uses that will benefit the nation in general and assist in the war effort in particular are vested in and on file at the Office of the Alien Property Custodian.

Enemy patents not already exclusively licensed to American interests prior to vesting are available to United States citizens under non-exclusive, royalty-free licensing for the remaining life of the patent. Patents from nationals of enemy-occupied countries are similarly available, but carry a reasonable royalty payable to the Custodian. If there is a return of patents to former owners in enemy occupied countries, the licenses will continue valid at the same royalty, unless a former owner is dissatisfied with the rate. In this case the right is reserved for him to negotiate with

# ACCURACY in the AnSCO Sweet Densitometer is maintained by built-in **CONSTANT VOLTAGE**

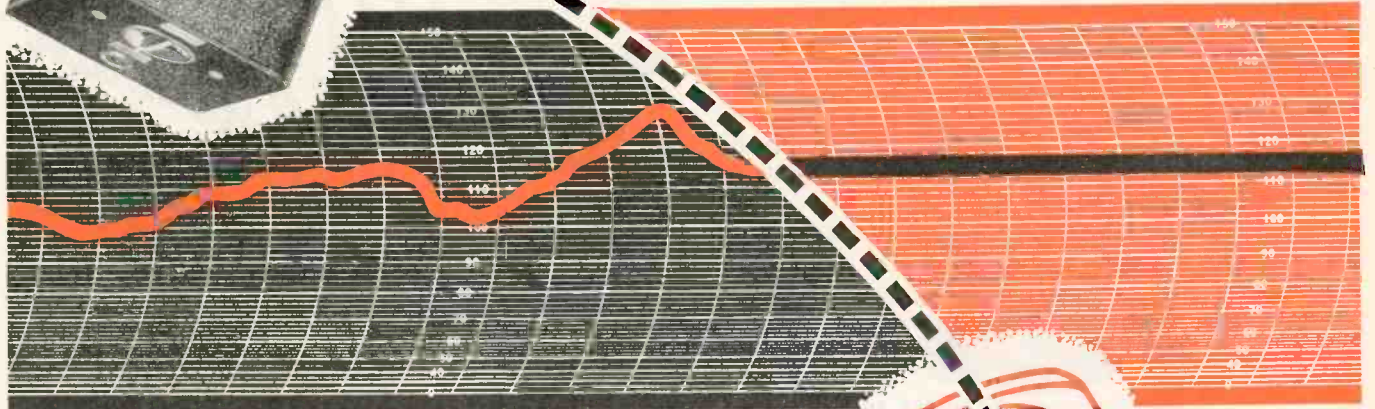

Redrawn from an actual tracing

**VOLTAGE VARIATIONS AS GREAT AS  $\pm 15\%$  ARE INSTANTLY CORRECTED TO WITHIN  $\pm 1\%$  OF THE DENSITOMETER'S PRECISE VOLTAGE REQUIREMENT**



The designers of the AnSCO Sweet Densitometer realized that the carefully controlled voltage of their laboratory would never be consistently available to their instruments in the field. Yet the operating voltage must be maintained within an allowable tolerance of  $\pm 1\%$  of rated requirements if instant and accurate answers were to be obtained in the study of the sensitometric problems for which it was designed.

In consultation with SOLA engineers a SOLA Constant Voltage Transformer was designed in correct

size and capacity and within economical cost limitations to be incorporated as a component part of the equipment. Laboratory voltage goes with the instruments into the field.

The same problem confronts *all* designers of electronic instruments or electrically operated equipment. And the same practical solution so successfully employed in the AnSCO Sweet Densitometer and many other similar instruments and devices is available—a SOLA Constant Voltage Transformer as a built-in component.

For the operation of precision instruments and equipment already in use, SOLA Constant Voltage Transformers are available in standard units in capacities from 10VA to 15KVA. Special units can be economically designed for any built-in application. Consultation *now* with SOLA engineers will provide a satisfactory solution for your problem.

# Constant Voltage Transformers

# SOLA

**To Manufacturers:**

*Built-in voltage control guarantees the voltage called for on your label. Consult our engineers on details of design specifications.*

Ask for Bulletin DCV-102

Transformers for: Constant Voltage • Cold Cathode Lighting • Mercury Lamps • Series Lighting • Fluorescent Lighting • X-Ray Equipment • Luminous Tube Signs  
Oil Burner Ignition • Radio • Power • Controls • Signal Systems • Door Bells and Chimes • etc. SOLA ELECTRIC CO., 2525 Clybourn Ave., Chicago 14, Ill.

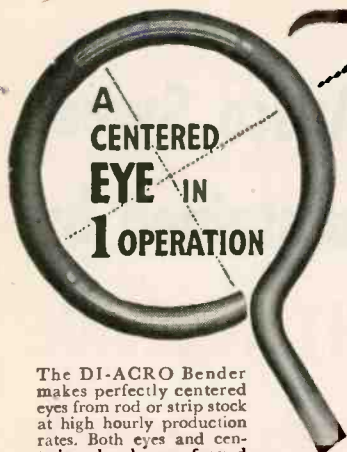

A  
CENTERED  
EYE IN  
1 OPERATION

The DI-ACRO Bender makes perfectly centered eyes from rod or strip stock at high hourly production rates. Both eyes and centering bend are formed with one operation. Any size eye may be formed within capacity of bender and ductile limits of material.

# Precision CENTERED EYE Bending

## With DI-ACRO Benders

DI-ACRO Precision Bending is accurate to .001" for duplicated parts. DI-ACRO Benders bend angle, channel, rod, tubing, wire moulding, strip stock, etc. Machines are easily adjustable for simple, compound and reverse bends of varying radii.

DI-ACRO Bender  
No. 1  
Forming radius 2"  
approx. Capacity  
3/8" round cold  
rolled steel bar or  
equivalent.



DI-ACRO  
Bender No. 2  
Forming radius  
6" approx. Capa-  
city 1/2" round  
cold rolled steel  
bar, formed cold  
to 1" radius. Also  
Bender No. 3,  
with forming ra-  
dius 9" approx.

Send for CATALOG  
"DIE-LESS" DUPLICAT-  
ING showing many kinds  
of "dieless" duplicating  
produced with DI-ACRO  
Benders, Brakes and Shears.



DI-ACRO is Pronounced "DIE-ACK RO"



# O'NEIL-IRWIN MFG. CO.

321 EIGHTH AVENUE SOUTH • MINNEAPOLIS 15, MINN.

Hook Up Those  
"LOOSE ENDS"  
in Your  
New Products  
By Specifying

**Sherman**  
Terminals  
and Lugs

ONE easy, practical way to speed up development work on your new units, is to turn over your Terminal and Lug problems to Sherman electrical engineers. You'll find that Sherman experience and "know-how" combined with the extensive Sherman production facilities can be extremely helpful to you in getting the right Lug or Terminal for every application.

Sherman can produce practically unlimited quantities of standard or specially designed Lugs and Terminals. Complete facilities are also available for hot tinning, electro-tinning, cad plating, etc. Write today. Let Sherman engineers help you solve your post-war problems NOW.

**H. B. SHERMAN MFG. CO.**  
BATTLE CREEK, MICHIGAN

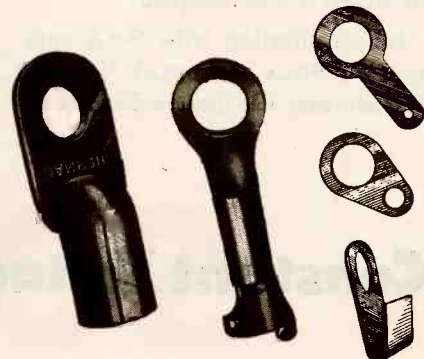

Sherman  
Closed Round  
End Solder-  
ing Lugs.

"Uni-Crimp"  
Solderless  
(pressure  
type) Ter-  
minals.

Soldering  
Terminals—  
hundreds of  
sizes and  
styles.

# If you want

- CRYSTALS
- CABLES
- HARNESES
- ELECTRONIC ASSEMBLIES
- CABINETS

Telephone Peru, Indiana  
**151**

Serving the Radio and Electronic Industries with precision engineered products.

# Wm. T. WALLACE MFG. Co.

General Offices: PERU, INDIANA  
Cable Assembly Division: ROCHESTER, INDIANA

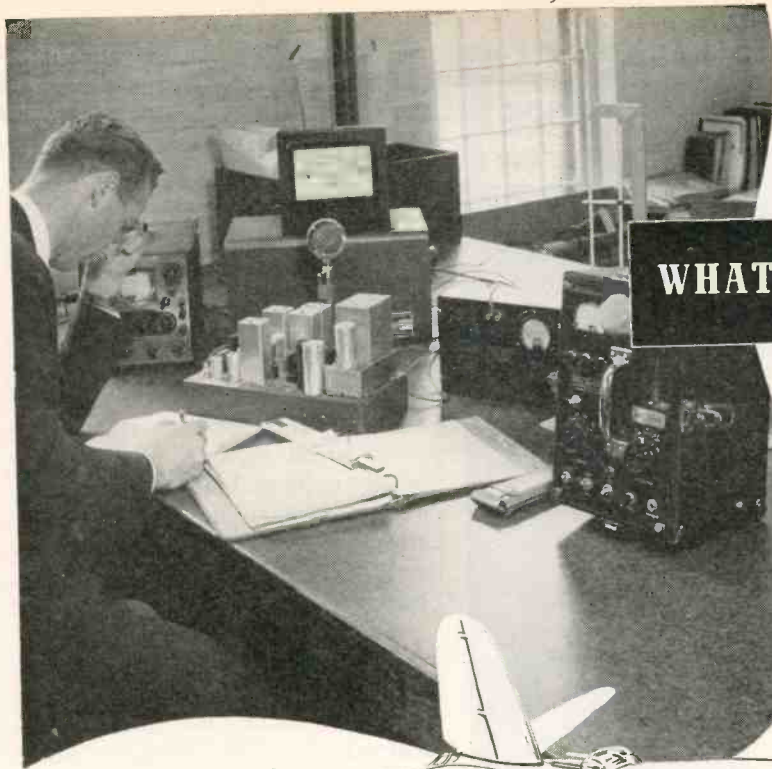

WHAT HAPPENS HERE . . .

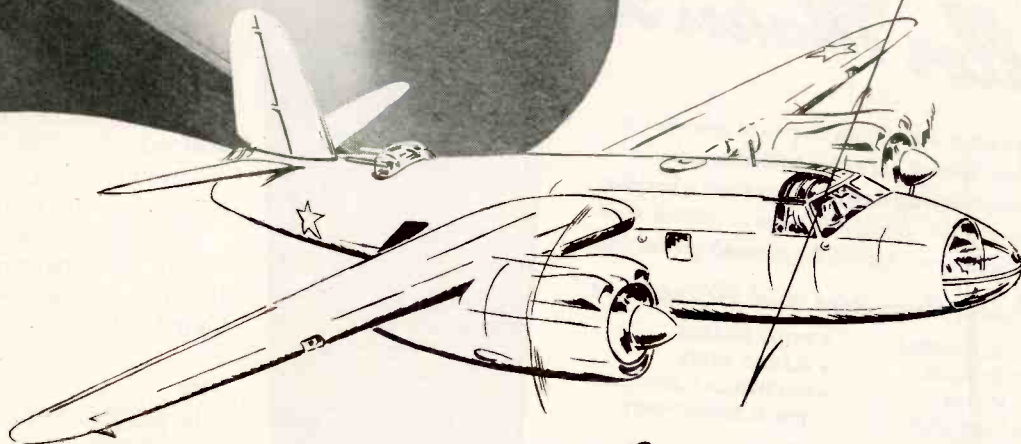

MEANS BETTER *Communications* HERE

Communications equipment designed for maximum efficiency doesn't roll off a high-speed assembly line. It's got to be painstakingly made that way!

Exactng precision is *engineered into* Harvey-Wells receivers and transmitters every step of the way. From the moment a communications problem is presented to us until the set is shipped out, each separate part, every engineering application, is closely analyzed, rigidly tested, inspected thoroughly and intensively. No gaps—no hurry—no half-way measures. Each piece of equipment must *earn* its own final stamp of approval.

That kind of communications equipment is constructed for *complete dependability*. That's the **ONLY** kind of communications equipment produced by Harvey-Wells.



Know the company that wants your business! Our CASE BOOK tells the story of Harvey-Wells and its place in Electronics. Send for it today. Your name on your letterhead is sufficient.

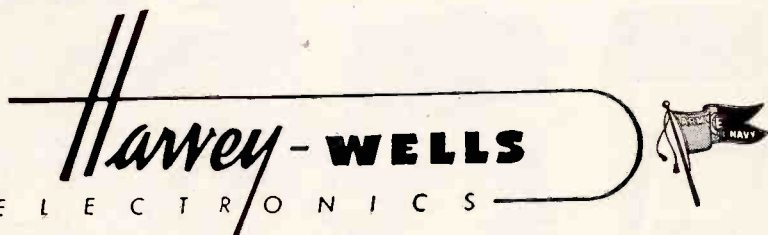

SETTING THE PACE FOR PROGRESS IN COMMUNICATIONS

HARVEY-WELLS ELECTRONICS, INC. SOUTHBRIDGE, MASSACHUSETTS

FOR POST-WAR REQUIREMENTS

40 YEARS OF EXPERIENCE AT YOUR SERVICE

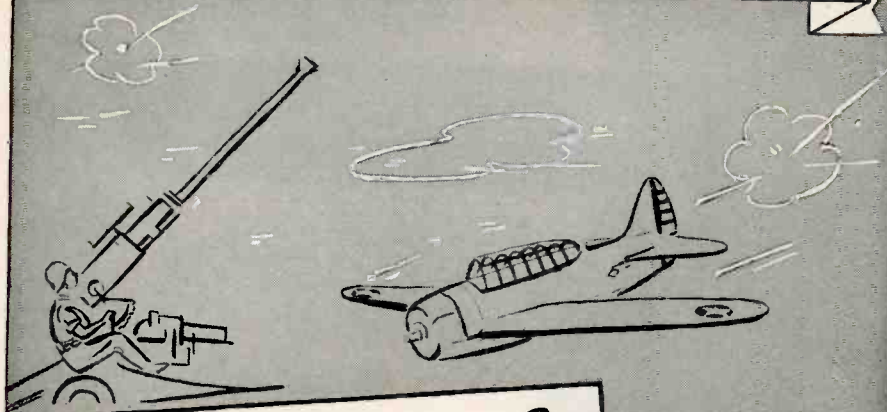

*Willor Makes It!*

... and makes it with a high degree of precision and cooperation born of our concentrated experience in meeting wartime's rigid requirements and schedules. From raw stock to completed items ... Willor service embraces every facility for planned production.

*We Invite Inquiries and Blueprints*

- METAL STAMPINGS
- MACHINE WORK
- LAMINATIONS
- TOOLS AND DIES
- PANEL BOARDS
- PLASTIC PARTS
- MECHANICAL AND ELECTRICAL INSTRUMENTS

**WILLOR**  
MANUFACTURING CORP.

794 E. 140th St., New York (54) N. Y.

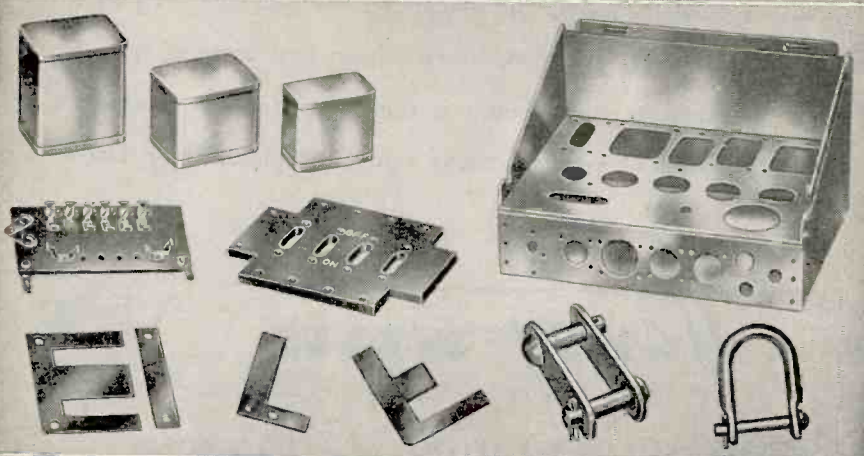

BACK THE ATTACK -- BUY MORE WAR BONDS

the licensee for an adjustment of the rate and if they cannot come to an agreement the matter is to be settled by arbitration.

Licenses on approximately 9,000 patents, including duplicates, have been issued by the Office of Alien Property Custodian to nearly 700 individuals and companies.

*Indexes and Abstracts*

An index to the abstracts of mechanical and electrical vested patents, which lists the classes into which patents have been divided, describes tersely the content of each class. Patent abstracts from the electrical and mechanical classes have been prepared in usual patent office style. The complete set, covering some 37,000 patents in four volumes, is obtainable for \$25. (Abstracts of about 8,000 purely chemical patents are in a separate set of 33 volumes at \$25.) Complete classes are also available separately.

Classes most likely to be of interest to ELECTRONICS readers with the class number and price are tabulated below.

Class	Title	Price
13	Electric Furnaces	\$0.10
18	Plastics	0.10
73	Measuring and Testing	0.25
84	Music	0.10
136	Batteries	0.10
173	Electricity, General Applications	0.25
178	Telegraphy	0.50
179	Telephony	0.50
201	Resistances and Rheostats	0.10
204	Chemistry, Electrical and Wave Energy	0.10
219	Electric Heating	0.25
250	Radiant Energy	1.00
274	Sound Recording and Reproducing	0.10

Class 178 also includes television patents. Class 250 will be of greatest interest to users of vacuum tubes, which subject comprises a great portion of this class.

*Reference Libraries*

Copies of vested patents and pending applications, classified catalogues, abstracts, special sublists and other cross reference material are available for inspection by the public without charge from 9 AM to 5 PM Monday through Saturday. The APC libraries supplying this service are at: Washington, D.C.; Chicago, Ill.; New York, N. Y.; Boston, Mass.; Portland, Ore.

In addition, public libraries in the following cities have copies of vested patents: Los Angeles, Calif.; Chicago, Ill.; Boston, Mass.;



**Gentlemen, we are ready to talk**

# ***SPEAKERS***

And we are ready to *make* them, too. Not today, of course—we've still got a war job to finish. After that we are prepared to break into volume production on those Speakers we have been telling you about for months.

How will they measure up? Well, back of these Speakers are nearly a quarter century of specialized engineering and mass production experience in practically all types of radio components—all to one high

standard. So, set manufacturers who are hopefully and logically looking to this line of Speakers for tone superiority and the best in modern design will find their expectations fully realized.

As a matter of fact, we are now ready to discuss orders—big orders—to submit samples on request.

**GENERAL ELECTRONIC APPARATUS CORPORATION**  
A SUBSIDIARY OF THE

**GENERAL INSTRUMENT CORPORATION •**



**829 NEWARK AVENUE • ELIZABETH 3, N. J.**

# Draftsmen Wanted

Also

## Designers, Detailers, Tracers and Engineers

We Offer

**A Permanent Position  
A Future with a promise  
of unlimited possibilities**

We have no conversion problem!

There will be no lay offs or set back when the war ends

We are one of the largest manufacturers of a wide variety of communication and electronic equipment in the world, fully prepared and ready to go ahead with a very ambitious, expansion program as quickly as we are permitted. There will be unlimited possibilities for creative, ambitious men to advance to key positions both in research development and production field. At present, we are producing vital equipment for our fighting forces.

**Good Starting Salaries—Exceptionally fine working conditions**

Apply Personnel Office 8 A. M. to 5 P. M.

**FEDERAL TELEPHONE & RADIO CORP.**

The Mfg. unit of the International Tel. & Tel. Corp.

591 Broad St., Newark, N. J.

W M C Rules Observed

# PyroFerric

## IRON CORES

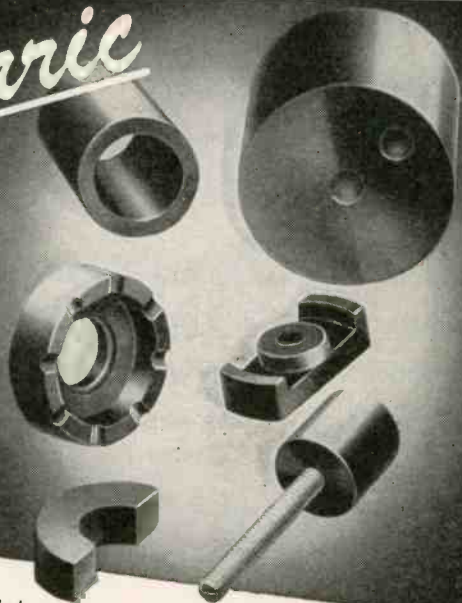

Pyroferric powdered metal cores have kept pace the vital precision instrument development. They are manufactured to specification:

"Q"

HIGH  
as desired FREQUENCY  
LOW

HIGH  
MEDIUM  
LOW

Consult Pyroferric on your Powder Metallurgy requirements

# PYROFERRIC Co.

175 VARICK STREET NEW YORK, 14, N. Y.

"Drop-test" proves

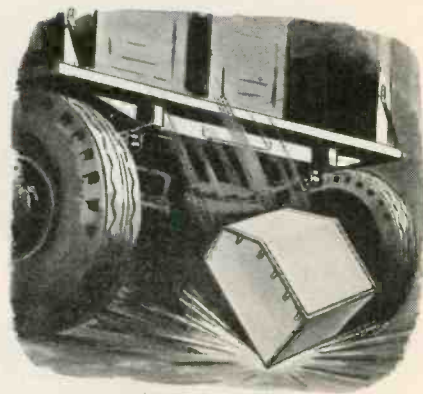

# Skydyne

## CABINETS

### TWICE AS STRONG FOR HALF THE WEIGHT

From a 48-inch level—the height of the average truck—two chests containing 75 pounds of dead-weight were dropped to a concrete floor.

One chest was of fabricated plywood; the other, a Skydyne Cabinet of aluminum-balsa-aluminum "sandwich construction."

Each was dropped, fully loaded, four times . . . first on one corner and then another.

At the end of the experiment, the plywood case was smashed. In marked contrast, the Skydyne Cabinet came through intact. The weight of the Skydyne Cabinet itself was only half that of the plywood cabinet.

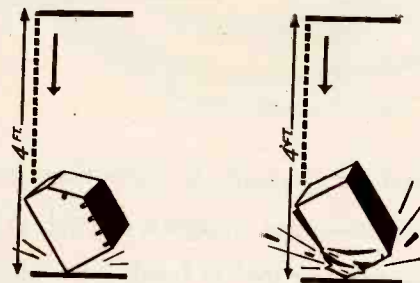

Such proved lightness and strength, however, are not the only reasons why thousands of Skydyne Cabinets are being used today to protect precision instruments in transit. Aluminum-faced Skydyne Cabinets are fungus resistant, water-tight, waterproof and rustproof as well . . . all highly important factors in tropical climates.

Nor is aluminum the only sheathing. Fibreglass, papreg and plywood can also be bonded with the balsa, cork or lightweight synthetic core and moulded to the most exacting specifications.

Skydyne construction is electrically shielded and is also resistant to heat, vibration and sound . . . a feature which suggests numerous applications now and after the war.

Get the whole story of Skydyne and learn how it will improve the appearance and serviceability of any product housing in which strength, light weight and special protection are essential. Write for our descriptive brochure.

# Skydyne Inc

PORT JERVIS, NEW YORK



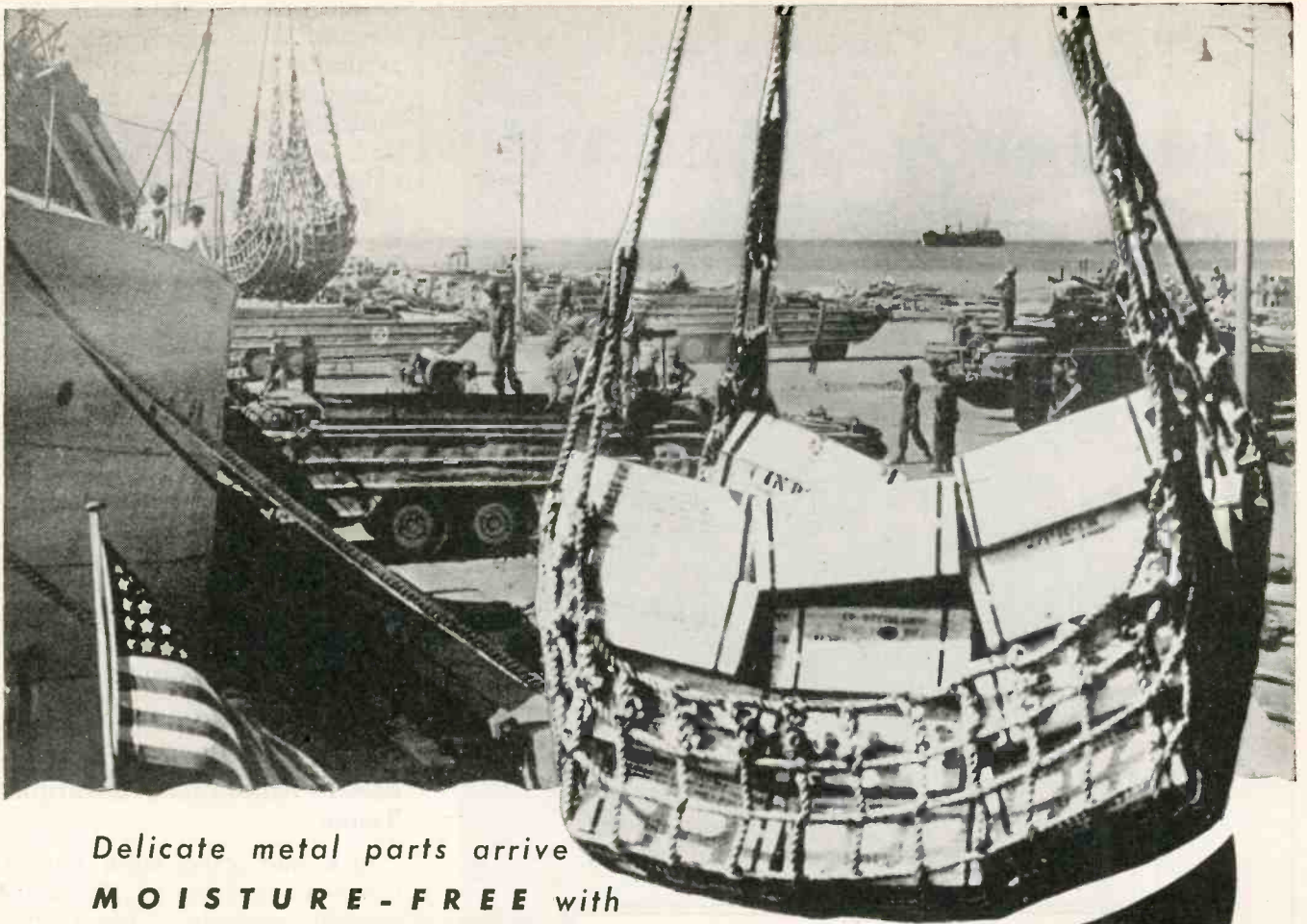

Delicate metal parts arrive  
**MOISTURE-FREE** with

# ★ Joliet **SILICA-GEL**

*The ideal drying agent....*

**T**HOUSANDS OF PACKAGES of delicate, precision metal parts are being delivered to our fighting fronts . . . moisture-free and rust free . . . because of Joliet Silica Gel.

The power of crystalline Joliet Silica Gel to absorb atmospheric moisture within containers is almost phenomenal. Its drying action prevents rust and corrosion. Moreover, it is widely used as a drying agent in cartons and boxes of foods, fabrics, chemicals and other commodities.

Joliet Silica Gel is strictly a quality product. It is clear white; passes a rigid section test;

meets exacting government specifications. Write today for full information.

### **Opportunity for Jobbers**

There are excellent opportunities for jobbers to build profitable business on Joliet Silica Gel in a few territories. Write for details.

**JOLIET CHEMICALS, LTD.**

INDUSTRY AVENUE  
JOLIET, ILLINOIS

# "Crystal Controlled" Frequency Standard



## Look at These Features!

- ★ Stable output up to 40 megacycles
- ★ Output circuit is tunable
- ★ Cool operation, even if continuous
- ★ Famous JK dual T8MD Crystal
- ★ Metal cabinet, grey crackle finish

**IMMEDIATE DELIVERY!**  
**Complete Price Only \$59.50**

**BUY MORE WAR BONDS**

**The JAMES KNIGHTS Co.**  
SANDWICH, ILLINOIS



**CRYSTALS FOR THE CRITICAL**

Detroit, Mich.; St. Louis, Mo.; Newark, N. J.; Albany (State Department of Education), Buffalo (Grosvenor Library) and New York City, N. Y.; Cincinnati, Cleveland, Columbus, and Toledo, Ohio; Philadelphia (Franklin Institute) and Pittsburgh, Pa.; Providence, R. I.; and Madison, Wis. (State Historical Society).

Copies of the catalogue and complete sets of abstracts are on file at district offices of Smaller War Plants Corporation and in many Chambers of Commerce.

For further information write to the Office of Alien Property Custodian, 120 Broadway, New York 5, N. Y., or 135 S. LaSalle Street, Chicago 3, Ill. Indexes and abstracts can also be ordered from either of these offices; make checks or money orders payable to the Alien Property Custodian.

• • •

## F-M and Television Broadcasters Announce Allocations Truce

In a joint action taken May 31 to speed a decision on the seven-year-old struggle between frequency-modulation broadcasting and television for space in the high-frequency radio spectrum, FM Broadcasters, Inc., and Television Broadcasters Association, the trade associations for the two industries, petitioned the Federal Communications Commission to adopt promptly an allocation plan satisfactory to both.

The plan upon which the two rival groups have finally joined hands is the first of the three FCC proposals concerning frequencies between 44 and 108 megacycles. It would give FM broadcasting 90 channels between 50 and 68 megacycles, a range in which present television stations now operate, and would give television 13 channels between 68 and 216 megacycles.

Prompt granting of the request by the FCC would permit both industries to prepare now for vast post-war expansion. It would enable them to avert unemployment which might result during the design and production engineering of equipment and sets. With cut-backs on war contracts already taking place in the electronics indus-

# TUBES

including Rectangular!

For electronic purposes, we supply tubes in all the usual sizes, and in shapes that include not only round, but square, rectangular and special. In certain alloys, for critical electronic uses, we can meet the current high requirements. See this list of Revere tubes:

## COPPER AND COPPER-BASE ALLOYS

Seamless Tubes • Condenser Tubes • Copper Tube for Water, Oil and Gas Lines • Dryseal Refrigeration Tubes • Pipe (S.P.S.) • Lock-Seam Tubes • Automobile Tubes • Capillary Tubing • Heat-Control Tubes.

## MAGNESIUM ALLOYS

Seamless Tubes • Pipe (S.P.S.) • Rocket Launching Tubes.

## ALUMINUM ALLOYS

Seamless Tubes • Lock-Seam Tubes • Pipe (S.P.S.)

## STEEL

Electric Welded Tubes • Perforated Tubes • Lock-Seam Tubes.

Remember that Revere is an increasingly-important supplier to the electronic industry, not only of tubes, but of regular and special copper and copper alloys, including a remarkable Free-Cutting copper that increases production rates, decreases rejections. There is a Revere distributor near you. He or we will be glad to answer any question.

# REVERE

COPPER AND BRASS INCORPORATED  
Founded by Paul Revere in 1801  
Executive Offices: 230 Park Avenue, N. Y. 17, N. Y.

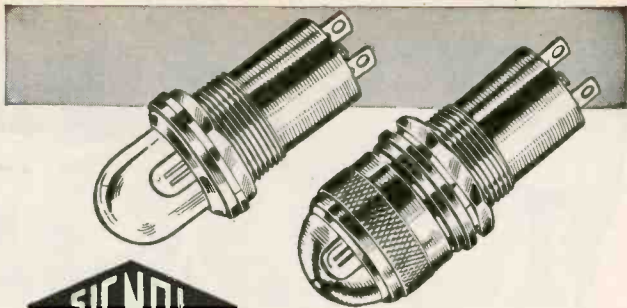

## NEON PILOT LIGHTS

EMBODY THESE IMPORTANT FEATURES:

*Penetrating orange-red glow . . . Long life . . . Low current consumption . . . Resistance to vibration and shock . . . Operate direct on high voltage circuits . . . Emit practically no heat. —*

These advantages of Neon Glow Lamps are enhanced by "SIGNAL" Pilot Light Assemblies. We manufacture a complete line, featuring types fitted with Full-View Plastic Heads. Specialists in supplying completely assembled units, housing G.E. or Westinghouse Lamps. Send specifications for prompt estimates and suggestions . . . Write for Catalog.

**SIGNAL INDICATOR**  
*Corporation*

894 BROADWAY . . . NEW YORK 3, N. Y.

Telephone: ALgonquin 4-4770

# Standard Relays

TO FIT YOUR JOB . . .

ILLUSTRATED ABOVE (actual size) is a Potter & Brumfield standard "MT" Series telephone type relay. This relay will handle operating voltages up to 60 volts DC. Overall dimensions, 1½" long, 1½" high, 1¼" wide. Weight 1¼ oz. One of the smallest, most compact ever built. Twin contacts, high contact pressure, particularly resistant to vibration.

This "MT" relay is typical of Potter & Brumfield standard relay models. Well designed, proven in actual service, they are sturdily constructed of the finest materials and will give the maximum of reliable, uninterrupted service.

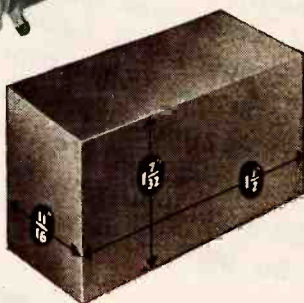
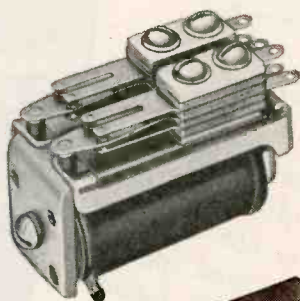

Potter & Brumfield standard relays will fit many applications and they give you most in dollar value. IF A STANDARD RELAY WILL DO THE JOB, THAT'S THE ONE TO BUY!

105 North 10th St.

**Potter & Brumfield**  
Mfg. Co., Inc.

PRINCETON, IND.



# APPROVAL

Snyder products have the endorsement of jobber, retailer and consumer alike. There's a recognition of the superiority of Snyder products.

ANTENNAE

by

**SNYDER**  
MANUFACTURING CO. • PHILADELPHIA

COMPLETE MANUFACTURERS  
FROM START TO FINISH



**"JUST TELL HIM ALBION CAN SHIP ALL THE  
COILS HE NEEDS... THAT'LL QUIET HIM."**

**SUPER-QUALITY COILS AT REASONABLE PRICES**

More and more every day, the industry is turning to Albion for fast, quality and quantity production of coils, chokes, and transformers. That's because here you benefit from the unbeatable combination of management "know how," skilled workmanship, streamlined facilities, and central location. Your requirements will be given prompt and thoughtful attention.

**ALBION  
COIL COMPANY**

ALBION, ILLINOIS

R. F. AND TRANSMITTING COILS AND CHOKES,  
I. F. TRANSFORMERS



## For more than 10 years

we have been manufacturing crystals. Not only are we crystal manufacturers, but crystal specialists as well. Consult us on your "crystal problems".



**PETERSEN RADIO CO.**

Council Bluffs, Iowa

CRYSTALS EXCLUSIVELY SINCE 1934

### Product efficiency— thru new concepts in fabricating techniques

One of the fundamental reasons for the widespread utilization of BAER fibre parts in essential applications today is the extra measure of accuracy afforded in fabrication. This fact—explained by the wide latitude of BAER specialized facilities for machining, stamping, punching, drilling and sawing—should step-up the efficiency of your post-war plantings. An inquiry does not obligate you in any way.



# Baer

## PHENOL AND VULCANIZED FIBRE FABRICATIONS FOR INDUSTRY

FREE LITERATURE — BAER engineers have compiled a 6-page data bulletin covering the "how" and "why" of both phenol and vulcanized fibre. A note on your letterhead will bring your copy promptly; write today for Bulletin 120.

**N. S. BAER COMPANY, 9-11 MONTGOMERY ST., HILLSIDE, N. J.**

try and due to increase as complete victory nears, design and engineering must take place without delay if civilian production is to dovetail with war work.

### Music Therapy

USE OF MUSIC from f-m receivers has made it possible for several Chicago dentists to do painful drilling without need for an anesthetic, according to Miss Violet Kmety of Zenith Radio Corp.'s station WWZR.

Speaking during National Music Week in Chicago, she pointed out that music from this station was particularly useful for these purposes since it is largely serious classics and has no distracting commercial announcements.

Other local applications include quieting the nerves and easing the minds of 2,700 donors a week at



At the Helderberg Mountain transmitter site of General Electric Co., near Schenectady, engineer George M. Brown talks with other GE engineers cruising in a 4-w f-m emergency mobile unit. The occasion was a two-day demonstration for members of the New York State chapter of APCO (Associated Police Communication Officers) of Radiotype and v-h-f (161.775 Mc) communications. In the foreground is one of the electromatic typewriters used in the system which involves perforating a tape, passing it over an automatic transmitting head which keys the transmitter with a tone signal, transmitting and receiving the keyed signal and electronically selecting the proper keys on the typewriter at the receiving end

**FERRANTI ELECTRIC, INC.**

*Transformers · Instruments*  
ELECTRONIC EQUIPMENT



TELEPHONE CIRCLE 7-0812-3  
CABLE ADDRESS FERRPATRAN

30 ROCKEFELLER PLAZA  
NEW YORK 20 · N.Y.

July 1, 1945

Mr. Chief Engineer:

We have available immediately, plant capacity for TRANSFORMERS, CHOKES, FILTERS, ETC., ETC. If you have any bottlenecks why not see us at once, as we can be of definite and immediate service to you.

This is a frank letter soliciting immediate business. To date we have had no cutbacks and we have sufficient business to see us well into 1946. However, due to greatly improved efficiency and increased manufacturing facilities, we have cleaned up our backlog at a greater rate than was originally anticipated, i.e. in the month of May, we completed and shipped over forty times as much business as we did in a similar month a few years ago.

Therefore, in the light of the above facts, we can entertain your orders for scheduling during the summer months.

Yours very truly,

FERRANTI ELECTRIC, INC.

*W. R. Spittal*

W. R. Spittal  
Vice-President



**METAL  
STAMPINGS**  
IN SMALL LOTS

Die cut metal stampings in limited quantities can be produced to your special requirements at 15% to 20% of the cost of permanent type tools. No matter how small your quantity requirements or how intricate your work, we can show you a definite saving. During our twenty-three years of specialized experience in this service, there has been no other method of producing metal stampings in small lots that can equal the process originated by Dayton Rogers.

Our new, illustrated booklet #176-17 will give you full particulars.

**DAYTON ROGERS MFG. CO.** 2835 12th Avenue So.  
Minneapolis, Minnesota

VITREOUS ENAMEL **RESISTORS**  
PRECISION WOUND  
**TELEPHONE SWITCH KEYS & JACKS**

TELEPHONE COMMUNICATIONS and CABLE ASSEMBLIES

*Weather-and-Fungus-Proofed*

*Backed by 20 years of winding experience. 75 Winding Machines*

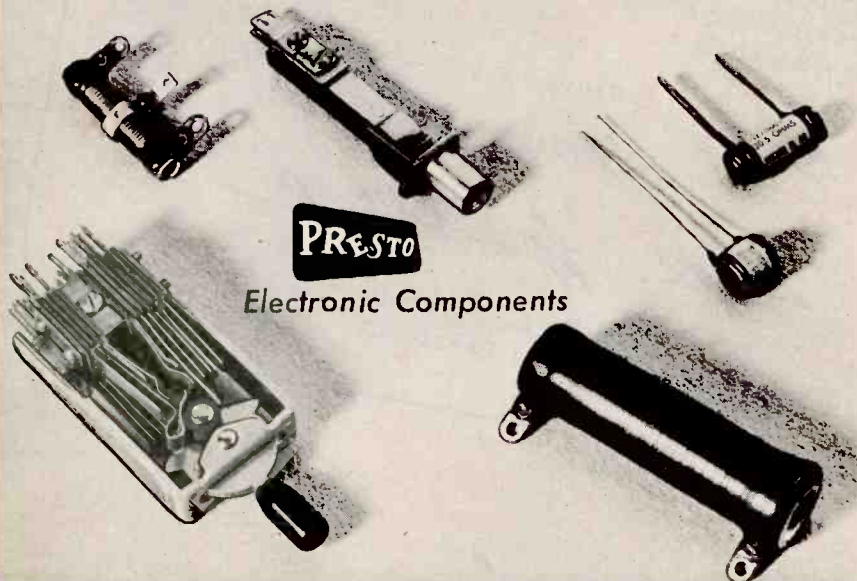

**PRESTO**

Electronic Components

**PRESTO ELECTRIC COMPANY**

Manufacturers of Signaling Devices  
UNION CITY, NEW JERSEY

For your present and  
post war electronic  
instrumentation.

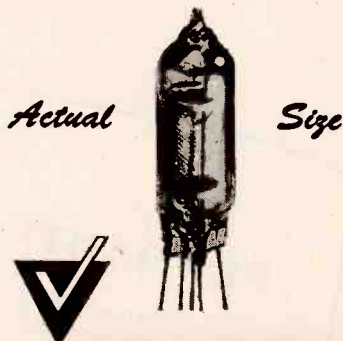

— SERIES VW —

A new 15 ma., 1.5 volt sub-miniature vacuum tube with —peak inverse potential up to several thousand volts— Grid current less than 10-14 amperes — grid resistance approximately  $10^{16}$  ohms.

Available as . . .

Electrometers  
Pentodes  
Tetrodes  
Triodes  
Diodes

. . . or to your specifications.

. . . and hand in hand with this tube development a new Victoreen Hi-Meg vacuum sealed resistor. Values from 1 megohm to 1,000,000 megohms.



Meeting the needs of fine instrumentation with unusual stability.

Write for our technical brochure on tubes and resistors.

**THE VICTOREEN INSTRUMENT CO.**  
5806 HOUGH AVENUE  
CLEVELAND 3, OHIO





# ATR VIBRATORS

## FEATURE:

- Longer Life
- Precision Construction
- Improved Performance

## INCLUDE

### ALL TYPES:

- Hermetically Sealed
- Light Duty (Auto radio)
- Heavy Duty (Inverter)
- Non-Synchronous
- Synchronous
- Shunt Coil
- Driver Coil
- 6 to 220 Volt D. C. Input

**INQUIRIES INVITED**

ATR Vibrators, the heart of vibrator-operated power supplies, are proven units of the highest quality, engineered to perfection. They are backed by more than twelve years of vibrator design and research, development and manufacturing—ATR pioneered in the vibrator field.

# ATR

*Preferred Precision Products*

- Vibrators
- Vibrator-Operated and
- Rectifier Power Supplies

**ATR LOOKING AHEAD!** Though now engaged in vital war work, with the immediate aim of victory, ATR is looking ahead. Our organization is being geared for the postwar requirements of the Radio-Electrical Industry. At present, only priority rated orders are being filled. However, we suggest that your postwar orders be anticipated and placed with us for prompt delivery. Write for catalog number 244. Backed by 14 years of "know how," **DEPEND ON ATR.**

## AMERICAN TELEVISION & RADIO CO.

*Manufacturers of Quality Products Since 1931*

**ST. PAUL, MINNESOTA, U. S. A.**

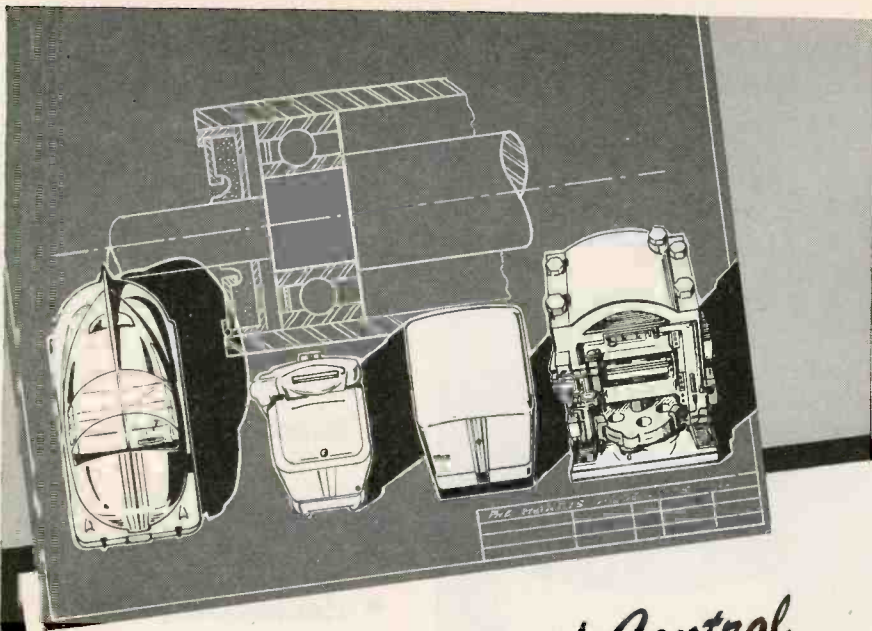

## How to Harness and Control **VIBRATION NOISES**

Today, vibration control on postwar equipment is a major subject with most of the leading equipment and appliance manufacturers because it adds greatly to the longevity, efficiency and performance of their products. Vibration control also means quiet, smooth operation which in turn is a potent sales point in selling appliances of all kinds.

Harris Torflex Flexible Bearings will prolong life, lower maintenance costs, insure more dependable and accurate operation and increase efficiency. This is done by absorbing shock, controlling vibration, silencing noises, providing flexibility for cushion and misalignment, transmitting torque, and eliminating wear and friction. Harris Torflex Bearings consist of a seamless tube of rubber which has been stretched between two concentric metal tubes, assuring high radial pressure which provides the required adhesion between rubber and metal. Torflex Bearings take axial, torsional, and radial loads and come in a wide range of sizes, carrying loads from ounces to tons. They are widely used and universally approved.

Harris pioneered in the field of engineered vibration control, consequently Torflex Flexible Bearings and Harris Mounts are widely used on prewar equipment, Army and Navy planes, military mobile units of all kinds, industrial equipment, automobiles, electrical and electronic products. If you have a vibration problem, our engineers would welcome an opportunity of working with your engineers, just drop us a line.

**HARRIS PRODUCTS CO.**  
CLEVELAND 4, OHIO  
U. S. A.

the Chicago Blood Bank and diverting the minds of caesarian mothers under local anesthetic.

### Hundred-Watter Sales

SUPPLEMENTING INFORMATION previously released on standard broadcast stations in other power categories, FCC now announces that net time sales for 1944 among 24 of the nation's 33 standard broadcast stations (28 commercial and 5 non-commercial) operating with power of 100 watts, increased 37 percent over the amount reported for 1943. All stations in this category showed increases. The total was \$983,639, an increase of \$263,476.

### Tropicalization Inspection

AS A RESULT of the increasing pitch of war activities in the Japanese theater of operation, the U. S. Army Signal Corps announces current use of an invisible dye to facilitate inspection of equipment treated for fungus and moisture detection.

This invisible or fluorescent dye is mixed with the lacquer which is sprayed on the equipment. Since the lacquer must be colorless to permit the reading of numbers and identification marks on the surfaces beneath, it is impossible to use visible dyes for determining paint coverage.

Checking is done with a special lamp high in ultraviolet emission and equipped with a deep purple filter.

A quick spot check which is sometimes used for the same purpose is executed with an ordinary pencil. Wherever the pencil glides as if on glass the spraying has been adequately done, but if it starts to write this indicates the presence of a weak spot in the covering.

### CONVENTIONS TO COME

SEPT. 17-21. AMERICAN SOCIETY FOR MEASUREMENT AND CONTROL. National Instrumentation Exhibit, Hotel William Penn, Pittsburgh, Pa., L. Susany, secretary, 4400 Forbes St., Pittsburgh, Pa.

### WASHINGTON NEWS

EXPERIMENTAL MODELS. In line with its announced policy of permitting reconversion as rapidly as

# STANDARD FOR COMPARISON



ALCO has been awarded for the fifth time the Army-Navy "E" Award for continued excellence in quantity and quality of essential war production.



## ALSIMAG

TRADE MARK REG. U. S. PAT. OFFICE

IT is a fact that other materials offered as insulators for electronic and electrical use may be judged by the degree to which they approach the combined properties of ALSIMAG Steatites. Study the Property Chart shown below. Whatever you are planning in the electronic or electrical field, the chances are ALSIMAG will do it better. Our specialized knowledge, and our engineering and research facilities are at your service. Let's work together.

### AMERICAN LAVA CORPORATION

Chattanooga 5, Tennessee

43RD YEAR OF CERAMIC LEADERSHIP

## MECHANICAL AND ELECTRICAL PROPERTIES OF ALSIMAG CERAMICS

ITEM	A.S.T.M. TEST NUMBER	UNIT	STEATITE				
			ALSIMAG A-35	ALSIMAG A-196	ALSIMAG 197	ALSIMAG 211	ALSIMAG 243
Specific Gravity	—	—	2.5	2.6	2.6	2.7	2.8
Density	—	lbs. per cu. in.	.090	.094	.094	.098	.101
Volume	—	cu. in. per lb.	11.11	10.64	10.65	10.26	9.91
Water Absorption	D116-42(A)	%	0—.05	0—.05	0—1	.08	0—.05
Color	—	—	White	White	White	White	Buff
Softening Temperature	C24-35	°C. °F.	1 450 2 642	1 440 2 624	1 445 2 633	1 400 2 552	1 440 2 624
Resistance to Heat (Safe Limit for Constant Temperature)	—	°C. °F.	1 000 1 832	1 000 1 832	1 000 1 832	1 000 1 832	1 000 1 832
Hardness	—	Mohs' Scale	7.5	7.5	7.5	7.5	7.5
Linear Coefficient of Thermal Expansion	—	Per °C.	6.9x10 <sup>-6</sup> 8.7x10 <sup>-6</sup>	7.3x10 <sup>-6</sup> 8.9x10 <sup>-6</sup>	7.7x10 <sup>-6</sup> 10.4x10 <sup>-6</sup>	7.3x10 <sup>-6</sup> 9.2x10 <sup>-6</sup>	9.1x10 <sup>-6</sup> 10.4x10 <sup>-6</sup>
Tensile Strength	D116-42	lbs. per sq. in.	8 500	10 000	8 500	7 500	—
Compressive Strength	D667-42T	lbs. per sq. in.	75 000	85 000	75 000	65 000	85 000
Flexural Strength	D667-42T	lbs. per sq. in.	18 000	20 000	20 000	18 000	20 000
Resistance to Impact (½" rod)	Charpy D667-42T	inch-lbs.	4.5	5	1.8	2.0	—
Thermal Conductivity (Approximate Values)	—	cal./sec./cm. per °C.	.006	.006	.006	.006	.008
Dielectric Strength (step 60 cycles) Test discs ¼" thick	D667-42T	volts per mil	225	240	210	240	240
Volume Resistivity	—	Ohms per Centimeter Cube	> 10 <sup>14</sup> 2.1x10 <sup>12</sup>	> 10 <sup>14</sup> 1x10 <sup>13</sup>	> 10 <sup>14</sup> 8.1x10 <sup>13</sup>	> 10 <sup>14</sup> > 10 <sup>14</sup>	> 10 <sup>14</sup> 5.0x10 <sup>13</sup>
Resistivity at Various Temperatures	—	Ohms per Centimeter Cube	6.0x10 <sup>7</sup> 3.2x10 <sup>5</sup> 2.3x10 <sup>4</sup> 7.0x10 <sup>3</sup>	1.8x10 <sup>9</sup> 9.0x10 <sup>6</sup> 5.0x10 <sup>5</sup> 7.0x10 <sup>4</sup>	2.5x10 <sup>10</sup> 8.8x10 <sup>7</sup> 4.2x10 <sup>6</sup> 6.8x10 <sup>5</sup>	9.0x10 <sup>12</sup> 3.5x10 <sup>10</sup> 4.8x10 <sup>8</sup> 2.5x10 <sup>7</sup>	7.0x10 <sup>11</sup> 1.2x10 <sup>10</sup> 1.0x10 <sup>9</sup> 3.0x10 <sup>8</sup>
Te Value	—	°C. °F.	440 824	640 1 184	840 1 544	> 1 000 > 1 832	> 1 000 > 1 832
Dielectric Constant	60 Cycles 1 000 K. C. 10 M. C.	D667-42T	6.1 5.9 5.8	5.9 5.8 5.7	6.3 6.0 5.8	— 5.8 5.7	6.3 6.2 6.2
Power Factor	60 Cycles 1 000 K. C. 10 M. C.	D667-42T	.015 .0035 .0030	.0022 .0021 .0015	.0020 .0012 .0010	— .0004 .0003	.0014 .0004 .00035
Loss Factor	60 Cycles 1 000 K. C. 10 M. C.	D667-42T	.09 .021 .017	.013 .012 .008	.0126 .0072 .0058	— .0023 .0017	.0088 .0025 .0022
Capacity Change Per °C.	—	parts per million	+ 160	+ 160	+ 160	+ 120	+ 130

# The "INSTANT COURIER"



**SENDING**

**SAVE TIN CANS**

**RECEIVING**

**FINCH FACSIMILE** is an "instant courier" for post-war communication. It will carry messages as far as wire or radio will reach—messages in your own handwriting, or pictures, or printed text—with complete fidelity: by telephone, 16 square inches per minute; by radio, three times that area! Plan to use this fastest, most accurate system.

**FINCH TELECOMMUNICATIONS, INC.,**  
Passaic, N. J.      New York Office: 10 E. 40th Street

**SELF SYNCHRONIZING**  **finch facsimile**



**Capacitance Decades**

- Accuracy at moderate cost. Three models are adequate for most laboratory and industrial applications (1%). Two models provide closer tolerances (.5%). Direct readings. Progressive small uniform steps. Three dials.

Calibrated directly in capacitance readings, left to right. Progressive adjustment in .01 or .001 steps, depending on model.

.001 to 11.1 mfd. can be obtained by group assembly.

All units with paper or mica dielectric capacitors of highest quality and stability.

Conservative voltage, accuracy and power factor ratings. Designed for continuous duty at rated voltage.

Hardwood cabinet. Hinged cover. Snap lock.

DK-3, 11.1 mfd. in .01 steps; DK-4 1.11 in .001; DK-2A, 1.11 in .001; DK-10, .111 in .0001; DK-11, 11.1 in .01.

● **Write for Literature . .**

**Industrial Instruments:**

**PLANT and OFFICES:**

17 POLLOCK AVENUE

JERSEY CITY 5, N. J.



**The Importance of MICA for National Defense**

Radio equipment used in tanks contains tubes and condensers in which Mica insulation plays a vital part.

**FOR EVERY RADIO ELECTRICAL AND ELECTRONIC USE**

**FORD RADIO & MICA CORP.**  
Joseph J. Long, President  
538 63rd Street, Brooklyn 20, N. Y.  
Established 1917 • Telephone: Windsor 9-9300

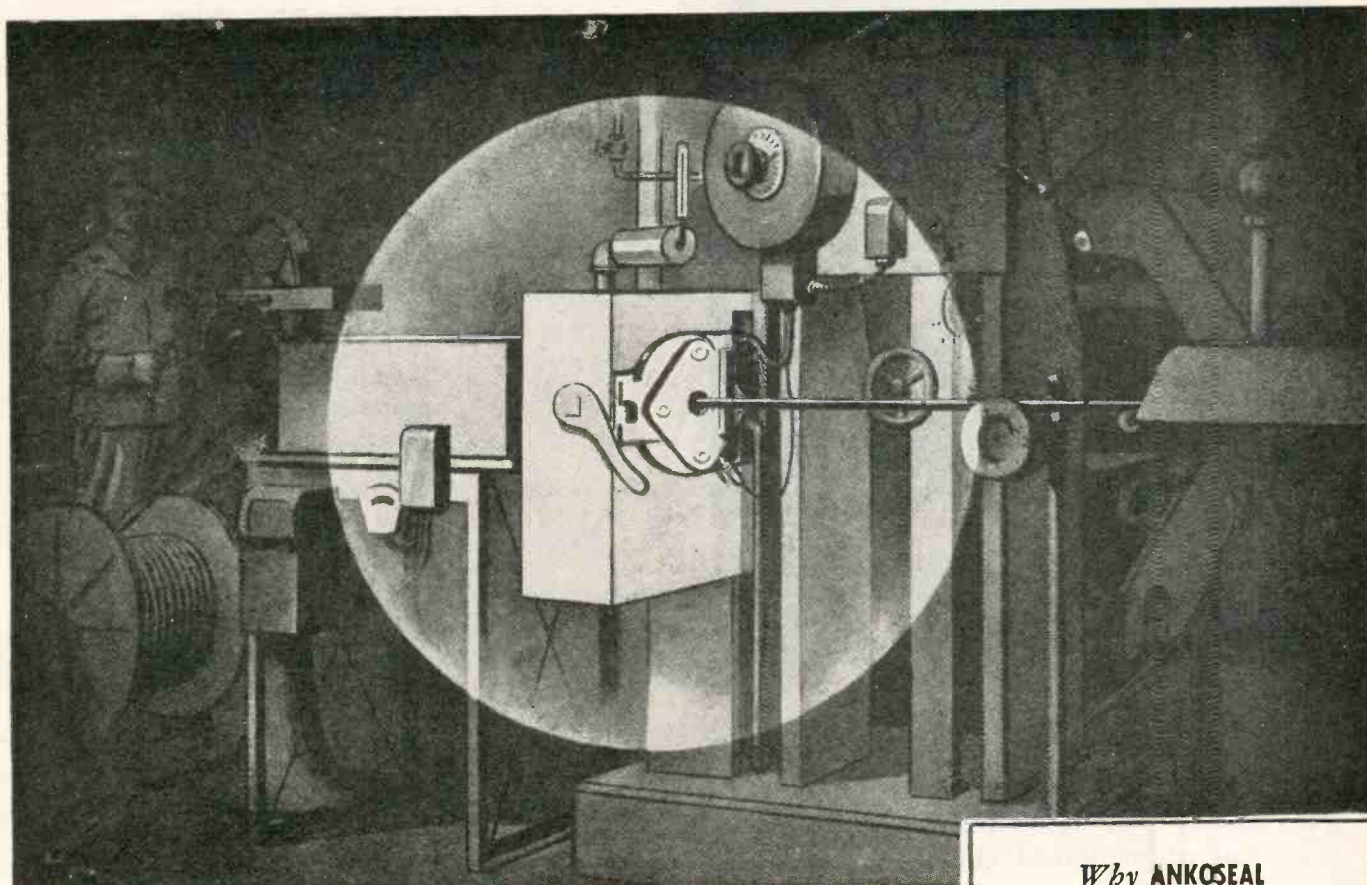

## Where's the Engineer in this picture?

**T**HE engineer isn't visible in the sketch—but he's there, behind every step in building Ankoseal cable! For, more and more, cables are engineered *and* manufactured to do particular jobs—especially here at The Ansonia Electrical Company!

Because of the many unusual cable demands of the Army and Navy which we have met, we are able to satisfy equally difficult requirements of other government agencies ... or of private concerns engaged in war work. Once we know what the function of the cable is to be, we take over—and from there to the finished product, in engineering and manufacturing, our organization works to deliver the form and type of Ankoseal cable best suited to that job.

That we stand ready to meet such requirements is indicated by our output record...made possible by "Yankee ingenuity" in manufacturing, implemented by emphasis on *continuing* laboratory research. These same facilities, this same ability, are offered to you.

So—if you have a cable problem—think of Ankoseal—and The Ansonia Electrical Company. We'll be glad to hear from you!

### Why ANKOSEAL solves cable problems

Ankoseal, a thermoplastic insulation, can help solve many electrical engineering problems, now and in the future. *Polyvinyl* Ankoseal possesses notable flame-retarding and oil resisting characteristics; is highly resistant to acids, alkalis, sunlight, moisture, and most solvents. *Polyethylene* Ankoseal is outstanding for its low dielectric loss in high-frequency transmission. Both have many uses, particularly in the radio and audio fields. Ankoseal cables are the result of extensive laboratory research at Ansonia—the same laboratories apply engineering technique in the solution of cable problems of all types.

## THE ANSONIA ELECTRICAL COMPANY



Specializing in "Ankoseal" a Thermoplastic Insulation  
ANSONIA • CONNECTICUT



A Wholly-Owned Subsidiary of

## NOMA ELECTRIC CORPORATION

GENERAL OFFICES • NEW YORK, N. Y.

—In peacetime makers of the famous Noma Lights—the greatest name in decorative lighting. Now, manufacturers of fixed mica dielectric capacitors and other radio, radar and electronic equipment.

# FOR POSTWAR BIMETALS

**BIGGER  
PRODUCTION**

**FASTER  
DELIVERY**

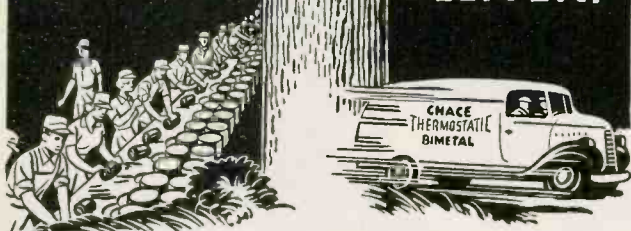

Out of wartime crucibles have come many by-products. Bimetals—developed for war needs—but of profound value in peacetime pursuits.

By new equipment and improved methods, Chace has vastly expanded its facilities for bigger production and faster delivery.

Today, this greater capacity and quickened service is being made available for the postwar demand for Chace Thermostatic Bimetals. To help in the production of such peacetime products as require dependable actuating elements for temperature responsive devices.

**W.M. CHACE Co.**

*Manufacturers of*  
Thermostatic Bimetals and Special Alloys  
1630 BEARD AVE • DETROIT 9, MICH.

**CHACE  
BIMETALS**

**35** DISTINCT  
TYPES  
★  
SOLD IN SHEETS, STRIPS  
and FINISHED FORMS

possible, WPB has relaxed restrictions on the production of experimental models. Thus, where WPB authorization was required for the expenditure of more than \$5,000 in a single plant in any calendar month in making models, no dollar limitation now exists. The order also removes the restriction on exhibition of models to the trade or to the public and permits distribution of experimental models for the purpose of promoting sales and creating consumer demand.

**SOUND EQUIPMENT.** It is reemphasized by WPB that intercommunication systems and public address systems may not be sold on the basis of maintenance, repair and operating. MRO orders can be used to add stations to existing intercommunication systems or to replace damaged amplifiers where repairs are impossible—but can never be used for installation of sound systems.

**RECEIVER PRICE STUDIES.** In anticipation of a return to civilian production, OPA (Office of Price Administration) officials are gathering data on manufacturing costs of radio sets, cabinets, and components preparatory to the fixing of ceilings in accordance with existing reconversion policies. From the point of view of parts, the operation comes under the direction of Earle H. Morse, chief of the electrical section, while sets and cabinets fall under the jurisdiction of Daniel L. Jacobs, chief of the radio and miscellaneous unit of the durable goods price branch.

**CIVILIAN PRODUCTS RELEASED.** Revocation of Order L-325 releases the production of 35-mm motion picture projection equipment, including sound and amplifying systems, for civilian use. Sixty other limitation orders revoked simultaneously cover a wide variety of types of equipment including resistance welders, electric office machines, motor controllers, and automatic music devices.

**RECEIVER MARKET.** Preliminary tabulations from the fourth nationwide survey taken by the Office of Civilian Requirements of WPB show that consumer demand for household appliances is far in ex-

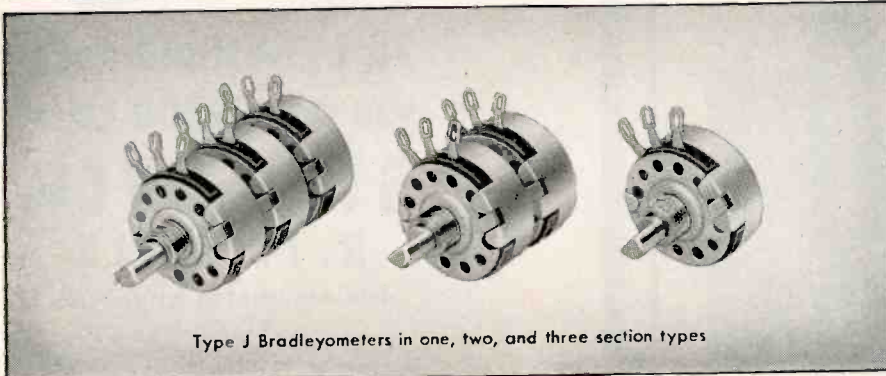
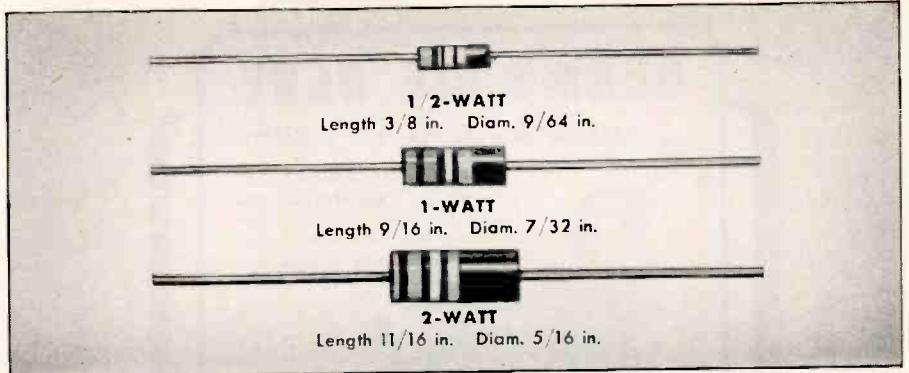
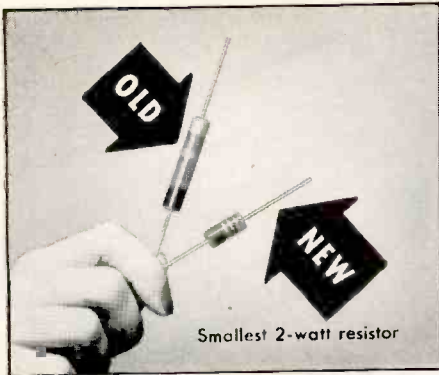

Type J Bradleyometers in one, two, and three section types



Carbon brush makes smooth contact

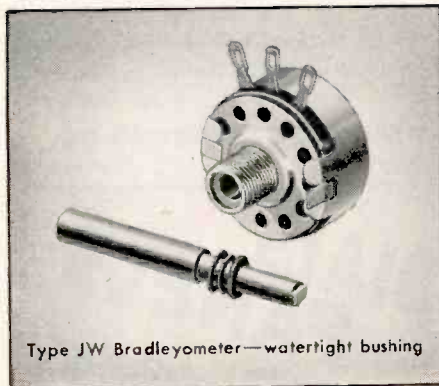

Type JW Bradleyometer—watertight bushing

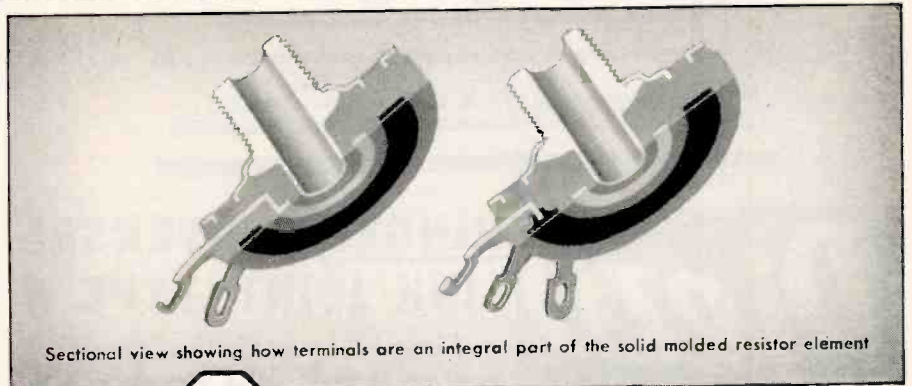

Sectional view showing how terminals are an integral part of the solid molded resistor element



# ALLEN-BRADLEY

## FIXED & ADJUSTABLE RADIO RESISTORS

QUALITY

**FIXED INSULATED RESISTORS**—Bradleyunits are available in 1/2-watt, 1-watt, and 2-watt ratings. They will sustain an overload of ten times rating for several minutes without failing. Wax impregnation is not necessary to pass salt water immersion test. The 1/2-watt and 1-watt units are available in all RMA standard values from 10 ohms to 10 megohms. Two-watt units available from 10 ohms to 1 megohm.

**ADJUSTABLE RESISTORS**—Type J Bradleyometers are the only continuously adjustable composition resistors having a 2-watt rating with good safety factor. Resistor element is solid molded and has substantial thickness. Not a film, paint, or spray type. Molded as single unit complete with insulation, terminals, face plate, and bushing. No rivets or soldered connections. Any resistance-rotation curve can be provided.

Allen-Bradley Company, 110 W. Greenfield Ave., Milwaukee 4, Wis.

WHEN DEPENDABILITY AND PERFORMANCE ARE "MUSTS"... THE EXPERTS SPECIFY ALLEN-BRADLEY

## GERMS DIE HERE

*... under temperature control!*

Surgical instrument sterilizers must not fail, that explains why Fenwal THERMOSWITCHES are specified as standard equipment. For positive temperature control, you can't beat a Fenwal THERMOSWITCH!

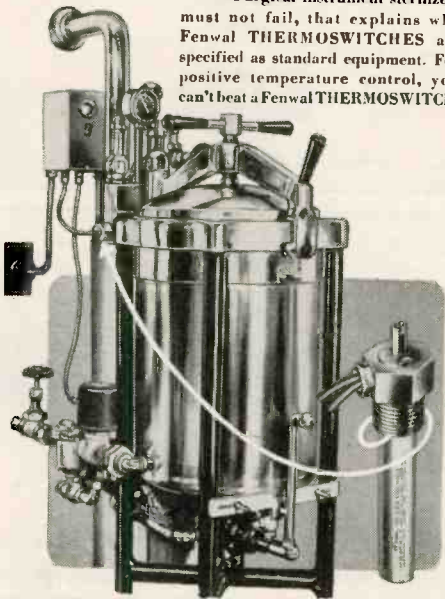

Write for catalogue and complete information ... to

**Fenwal** INCORPORATED  
ASHLAND · MASS.



## A BOX TO REMEMBER when you want GOOD coils

# STANWYCK

## R. F. COILS

AND ASSOCIATED ASSEMBLIES

There is a Stanwyck coil for every application in the Radio Frequency Spectrum — coils that have met the requirements of war and which will meet your requirements when the war is won ... Send for folder describing our line and facilities.

**STANWYCK WINDING CO.**  
NEWBURGH NEW YORK

# Piezo

TRADE MARK

## HINGED UNIVERSAL LINK JOINT-TYPE 'H'

### Simplifies installation of REMOTE CONTROLS

The type "H" hinged Universal Link Joint with solid shafting has three distinct advantages for remote controls. (1) Simplicity of installation (the Universal Link Joint hinges from 0 to 90°). (2) A minimum of backlash. (3) Output shaft turns in exact angular rotation with the input shaft.

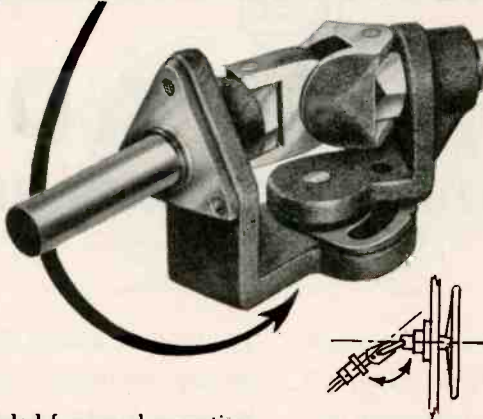

This method is particularly recommended for panel operation of dial and rheostat controls, switches, variable condensers, variable transformers, coils, remote operating rods and other mechanical adjustments.

Write for Bulletin 45B for complete data and specifications.



# PIEZOELECTRIC CORPORATION

110 EAST 42nd ST., NEW YORK 17, N. Y.

## DIALS PANELS and PLATES



35 years  
of service to  
American  
Industry

**DIALS · PANELS · PLATES**  
made to your precise engineering specifications in etched metals and finishes.

# PREMIER

## METAL ETCHING CO.

21-03 44th AVE.  
LONG ISLAND CITY, NEW YORK





# Policing Production

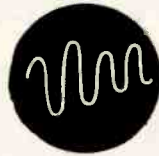

VARIABLE SOUND WAVES

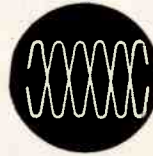

ELECTRICAL WAVES



BROADCAST WAVE



RADIO INTERFERENCE



CHECKING A TELEVISION SET.

## with **JEROME** STILL & MOTION PICTURE CAMERAS

These graphs show what the eye sees on the fluorescent screen of an oscillograph. By using the JEROME Data Camera to photograph these tests at intervals of a few seconds or minutes, as required, you get a permanent record of your tests, and one that may be studied at leisure.

This is only one of many useful tasks on which the JEROME Automatic Still and Motion Picture Camera may be employed.

Changed to a motion-picture camera at the flick of switch, the JEROME makes Time Studies in Electronic Manufacturing. Or — it portrays shop methods, for instructing novice workmen in their training period. See the 28 uses outlined in the table opposite.

This rugged, 35mm camera, with every part strongly built to resist vibration or shock, is extraordinary in so many ways that we may only hint at them here.

For instance, heating equipment, controlled by thermostat, permits motion-pictures at a temperature of 60° F. below zero. For work

in the dark, or in shadowy spots the camera provides its own illumination.

There are two shutters, one for each class of work, and mounting for three different lenses, of which two are provided as standard equipment.

Speeds — On Movie Work — approximately 4 to 64 frames per second. On Data Work — intervals of from 15 seconds to 30 minutes. Furnished with substantial tripod, or may be rigidly clamped to bench or fixture. Read all about this unusual Industrial Camera. WRITE FOR FULL INFORMATION.

### 28 Ways to Use JEROME Cameras

- 1 Photograph Instrument panels, registering instruments, single, multiple frame, at pre-determined intervals.
- 2 Gun camera — recommended for heavy guns — 35 mm. Superiority over 8 mm., 16 mm.
- 3 As an Ordinary Camera: Despite special design camera can be used as regular 35 mm. camera.
- 4 Ground and aerial reconnaissance, surveys.
- 5 Recording duplications, Maps, Mail, valuable documents.
- 6 Medical research, fluoroscope screen and microscopic photographic recording.
- 7 Chemistry, records chemical research & action.
- 8 Coast Survey, Aerial Reconnaissance, Recording of depth and sounding instruments.
- 9 Buoy survey and patrol of sea in critical areas.
- 10 Electronic Research Instrument, photographically records cathode ray, oscilloscope.
- 11 Detection, automatically photographs objects passing within camera range.
- 12 Test work, general instrument, recording test performances, techniques.
- 13 Training Film, all types of school and educational photographs for training purpose, class room.
- 14 Deck Observation Camera, records deck action or position of ships in convoy.
- 15 Production Check Camera, checks machine, manual operations, increasing efficiency.
- 16 Aerial observation. At pre-set intervals will photograph landscape below at high altitudes.
- 17 Engineering Work, Used in construction of ship hulls, bridges, construction analysis.
- 18 Performance Guide, manual operation, gun crew action. Recording for future study.
- 19 Aircraft Landings & take-offs mounted on control tower. Records unusual incidents.
- 20 Aerodynamics research and flight test operations.
- 21 Material Testing, Automatic testing characteristics of materials, recording for analysis.
- 22 Meteorology, Isolated weather instruments and cloud formation and climatic study.
- 23 Traffic Check, Dangerous road intersections, Tunnel and bridge traffic analysis.
- 24 Marine observation, underwater photography flaura, fish habitats.
- 25 Firing Data Recording, Complete gun firing record, corrector range and site.
- 26 Front Line Warfare, Tank and listening post observation.
- 27 Restricted Area Detection, Registers pedestrian traffic thru gates, doors.
- 28 Photoelectric Cell operating camera operating from sound and vibrator detection.

## JEROME ENGINEERING CO. MASSAPEQUA, L. I., N.Y.

ORIGINATORS OF THE AUTOMATIC RECORDING CAMERAS  
BUILDERS OF PHOTOGRAPHIC EQUIPMENT  
UNIVERSAL CAMERAS FOR EVERY TECHNICAL REQUIREMENT

PHONE: MASSAPEQUA 2100

# QUICK DELIVERY ON LEADING MAKES OF WIRE & CABLE for Radio and Power Use



## STOCKS OF MANY TYPES ON HAND

Meeting urgent needs for Wire and Cable is a specialized job at ALLIED. From this one central source, shipments go constantly to industry, armed forces, government agencies and research laboratories. Here are gathered all leading makes, in all wanted types, for radio and power use.

BELDEN ALPHA LENZ CORNISH  
ANACONDA CONSOLIDATED AMPHENOL

Power • Multi-Conductor • Solid and Stranded  
Natural and Synthetic Rubber-Covered  
Shielded • Indoor and Weatherproof • Coaxial  
Transmitting and Receiving • Telephone  
Microphone • Intercom • Hook-up • High-Tension  
Magnet • Aerial • Twisted Pair • Lamp Cord

Large and varied stocks of Wire and Cable are maintained for rush service. Close contact with manufacturers expedites procurement. Whether your requirements be large or small—save time and work—call ALLIED first!

WRITE, WIRE, OR PHONE HAYMARKET 6800  
for Everything in Radio and Electronics

Helpful  
**BUYING  
GUIDE**  
Available  
on Request  
Write for it!

## ALLIED RADIO CORPORATION

833 W. Jackson Blvd. • Dept. 24-G-5 • Chicago 7, Illinois

SUPPLIERS OF ELECTRONIC PARTS AND EQUIPMENT TO INDUSTRIAL AMERICA  
Electronic Tubes, Rectifiers, Power Supplies, Intercommunicating Systems, Sound Systems, Photo-Cell Equipment, Batteries, Chargers, Converters, Generators, Supplies for Resistance Welders, Fuses, Test Instruments, Meters, Broadcast Station Equipment, Relays, Condensers, Capacitors, Resistors, Rheostats, Transformers, Switches, Coaxial Cable, Wire, Soldering Irons, Microphones, Speakers, Technical Books, etc.

cess of the demand in any year before the war. Including only households, and not apartments and new housing, the figures represent demands as of the date of the survey, which was shortly before V-E Day. Assuming that supplies were ample, it is projected from the results that 5,085,000 radios were in demand as against only 2,682,000 a year ago. From the second-hand point of view it was brought out that 429,000 households had sought unsuccessfully to purchase radios, while 913,000 found units to buy. 13 percent of these were new. Radios were the only items among household appliances where the number actually bought exceeded the number looked for unsuccessfully.

**QUARTZ CRYSTALS.** An amendment to Conservation Order M-146, issued by WPB, eliminates the provision for application of certain quartz crystal production under the spot authorization plan. Consumers in hardship cases are directed to appeal by letter to the Miscellaneous Minerals Division. The new order allows the use of quartz in the manufacture of research or production instruments on any ratings and also eliminates a former prohibition against fabricating radio oscillator plates and filters from quartz scrap.

## FCC ACTS

To permit this station:

WJXN  
Jackson, Miss.

WJAX  
Jacksonville, Fla.

WPAG  
Ann Arbor, Mich.

W4XAP  
Birmingham, Ala.

W2XCS  
New York, N. Y.

— — — —  
Cadillac, Mich.

KEUB  
Price, Utah

WSTN  
Staunton, Va.

— — — —  
Tulare, Calif.

— — — —  
Milwaukee, Wis.

WLBG  
Philadelphia, Pa.

KCRA  
Sacramento, Calif.

WBHD  
Petersburg, Va.

To do this:

Operate a new station on 1490 kc, 250 w, unlimited time.

Operate new auxiliary transmitter.

Operate a new station on 1050 kc, 250 w, daytime.

Operate a new developmental broadcast station on frequency to be assigned, 250 w.

Extend completion date for new experimental television broadcast station to Nov. 12, 1945.

Construct a new station to operate on 1240 kc, 250 w, unlimited time.

Change call letters to KOAL.

Construct a new station to operate on 1400 kc, 250 w, unlimited time.

Construct a new station to operate on 1240 kc, 250 w, unlimited time.

Construct a new developmental broadcast station at the transmitter site of WMFM. Emission: A0 and special for FM.

Change call letters to WIBG-FM.

Operate a new station on 1340 kc, 250 w, unlimited time.

Change call letters to WSSV.

# "GREATNESS IS NOTHING BUT MANY SMALL TRIFLES"

Old Proverb

The precision required of Connecticut Telephone & Electric Division's production keeps us on our toes . . . developing new and better manufacturing methods . . . devising improved techniques of quality control. One example is the crystal tester developed by our engineers which gives us a quality check in quantity.

This is one of many special instruments in Connecticut Telephone & Electric Division's plants. Each is designed to assure our armed forces of better products. Each one contributes its trifle of greater dependability and higher accuracy to the electronic and communications equipment you will use after the war.



## Eliminating the element of human error

To meet modern standards of manufacturing, random spot checks are not enough. At the left is a sweep balance recorder, recently developed in our engineering department, for making 100% production tests of radio crystals. It makes a permanent and simultaneous record of frequency deviation and activity vs. temperature. It plots 71 two-curve diagrams with a total of 4,000 measurements, in less than an hour. This instrument is adaptable to diversified industrial applications which require the recording of two sets of variables.



**CONNECTICUT TELEPHONE & ELECTRIC DIVISION**  
GREAT AMERICAN INDUSTRIES, INC. • MERIDEN, CONNECTICUT

# ELECTRICITY

FOR ANY JOB  
—ANYWHERE

★ **ONAN ELECTRIC GENERATING PLANTS** supply reliable, economical electric service for electronics applications as well as for scores of general uses.

Driven by Onan-built, 4-cycle gasoline engines, these power units are of single-unit, compact design and sturdy construction. Suitable for mobile, stationary or emergency service.

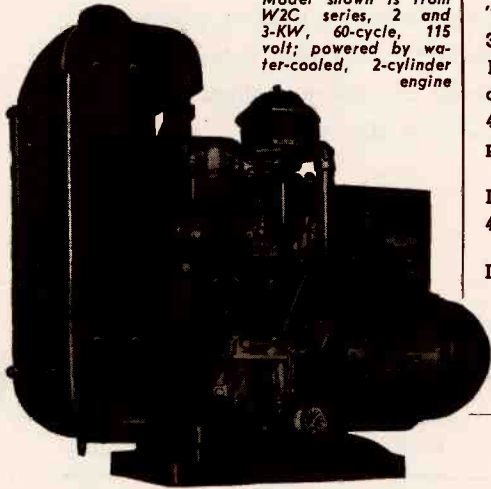

Model shown is from W2C series, 2 and 3-KW, 60-cycle, 115 volt; powered by water-cooled, 2-cylinder engine



"Models range from 350 to 35,000 watts. A.C. types from 115 to 660 volts; 50, 60, 180 cycles, single or three-phase; 400, 500, and 800 cycle, single phase; also special frequencies.

D. C. types range from 6 to 4000 volts.

Dual voltage types available. Write for engineering assistance or detailed literature".

**D. W. ONAN & SONS** — 3286 Royalston Ave. Minneapolis 5, Minn.

## Radio-Electronic Materials

• Try us for those items you need in a hurry. Our stocks are big—our service, extra-fast!

We've been at it since 1925 —and we know how!

*Just Try Us*

**F. I. ALLEN, INC.**

Wholesale Distributors  
RADIO-ELECTRONIC SUPPLIES & PARTS  
17 Union Square  
NEW YORK 3, N. Y.

Phones ALgonquin 4-8112-3-4-5-6-7

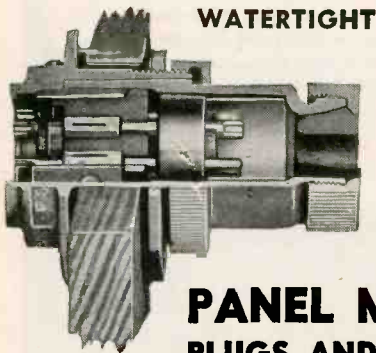

WATERTIGHT

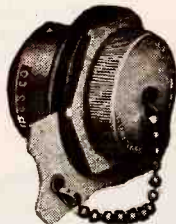

### PANEL MOUNTING PLUGS AND RECEPTACLES VIBRATION-PROOF ASSEMBLIES

For locknut or bolted style mounting to panels 1/16" to 5/8" thick. Precision built housings — light weight, ample wiring space.

Contacts fully machined, self wiping and free floating. All terminals identified. Polarized, grounded and shielded.

Interior moulded bakelite. Moulded rubber gaskets on watertight style.

Thousands in use for vital war service.

Since 1902

Please address Dept. No. H



### RUSSELL & STOLL COMPANY

EXPLOSION-PROOF, WATER-TIGHT, INDUSTRIAL LIGHTING FIXTURES AND EQUIPMENT. AUTOMATIC LOCKING "EVER-LOK" CONNECTORS  
125 BARCLAY STREET · NEW YORK 7, N. Y.

**EVERLOK**  
AUTOMATIC LOCKING

- FOR PORTABLE SOUND AND SIGNAL SYSTEMS 2 to 12 POLE
- FOR POWER 10 to 200 AMP. 2, 3 & 4 POLE

## The IMPROVED KELNOR electric SOLDERING IRON

REG. U. S. PAT. OFF.

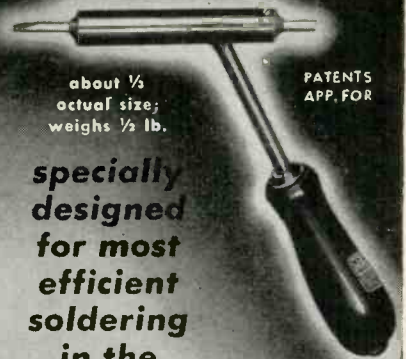

about 1/3 actual size; weighs 1/2 lb.

PATENTS APP. FOR

specially designed for most efficient soldering in the

**ELECTRONIC, RADIO AND INSTRUMENT manufacturing and repairing fields**

Easily solders hard-to-reach connections. Cuts down fatigue, increases accuracy.

ORDER FROM YOUR JOBBER, OR DIRECT. GENERAL OFFICES: CENTRAL TOWER, SAN FRANCISCO 3

**KELNOR MANUFACTURING COMPANY**

"When Ordering Please Mention Electronics"

# What do you need in metals



## ECONOMY

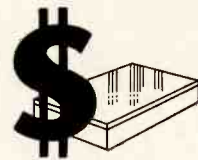

## CORROSION RESISTANCE

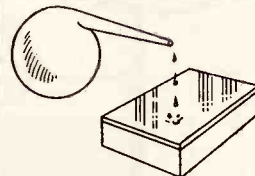

## EASE OF FABRICATION

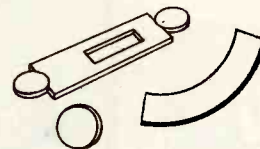

## EASY SOLDERING



## ELECTRICAL CONDUCTIVITY

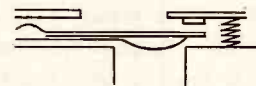

## SHEET, WIRE, TUBE

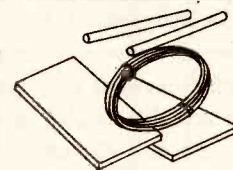

## *You'll find the answer in General Plate Laminated Metals*

The versatility of General Plate Laminated Metals makes possible the fabrication of parts with exceptional electrical performance . . . corrosion resistance . . . mechanical and structural properties . . . long wearing life . . . and economy.

By permanently bonding precious metals to base metals, General Plate Laminated Metals give you solid precious metal performance at a cost slightly higher than the base metal. Base to base metal combinations provide special performance requirements not found in single base metals.

No matter what your metal requirements in such appli-

cations as electronic devices, electrical products, signal control apparatus, chemical equipment . . . anything from peanut radar tubes to giant turbines, it will pay you to investigate General Plate Laminated Metals for present and post-war products.

They are available in sheet, wire and tube form . . . in-laid or wholly covered . . . or as fabricated parts. Many new clad combinations, developed since the war, are also now available. Our engineers are available for consultation. Write for their services.

### **General Plate Division** **of Metals & Controls Corporation**

50 Church St., New York, N. Y.; 205 W. Wacker Drive, Chicago, Ill.; 2635 Page Drive, Altadena, California; Grant Bldg., Pittsburgh, Pa.  
**ATTLEBORO, MASSACHUSETTS**

**New in Principle!  
Revolutionary in Range!**

## CML MODEL 1200 STROBOSCOPE

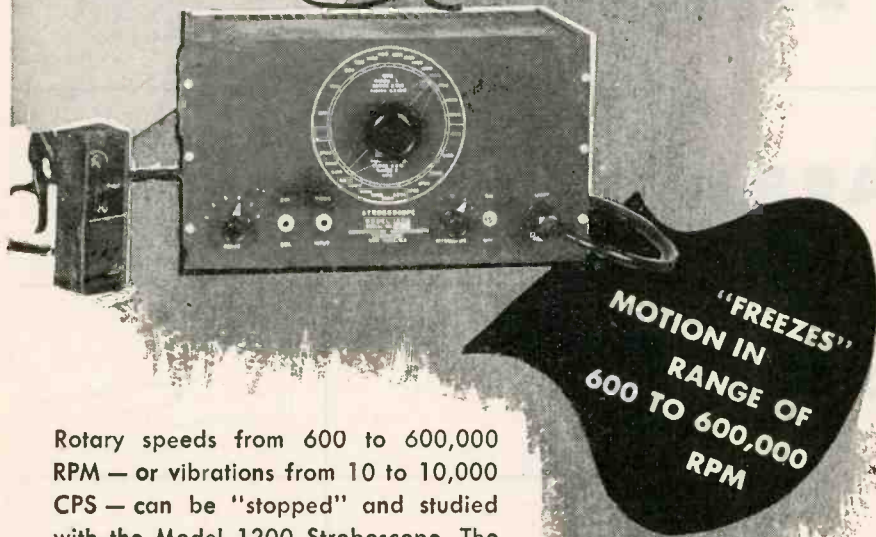

**"FREEZES"  
MOTION IN  
RANGE OF  
600 TO 600,000  
RPM**

Rotary speeds from 600 to 600,000 RPM — or vibrations from 10 to 10,000 CPS — can be "stopped" and studied with the Model 1200 Stroboscope. The light source is mounted in a small probe at the end of a five-foot flexible cable.

This makes it easy to examine small objects at close range. Provision is made to operate the unit from external tuning fork or crystal standards, where extreme accuracy is required. The motion of objects moving at irregular speeds may also be "stopped" with the Model 1200. An accurate repetitive pulse rate is obtained, as the pulses are derived from a stable audio oscillator.

Not only does this eliminate the necessity for constant readjustment of the repetitive rate, but it also insures clearly defined images at high speeds.

For greater flexibility, a light intensity control switch is also provided. This enables the user to control both the intensity of the light and the duration of the pulse length.

**WRITE FOR  
DESCRIPTIVE  
BULLETIN**

## COMMUNICATION MEASUREMENTS LABORATORY

Rotobridge • Electronic Generators • Power Supply Units  
120 GREENWICH ST., NEW YORK 6, N. Y.

- — — — —  
Massena, N. Y. Construct a new station to operate on 1340 kc, 250 w, unlimited time, contingent on WPB authorization.
- — — — —  
Santa Maria, Calif. Construct a new station to operate on 1450 kc, 250 w, unlimited time, contingent on WPB authorization.
- KINY  
Juneau, Alaska Operate with increase in power, newly installed transmitter, and changes of antenna.
- — — — —  
Columbis, Ohio Construct a new relay broadcast station to operate with WOSU.  
W7XTE Extend completion date of new developmental broadcast station to Dec. 30, 1945.  
Portland, Ore.
- W3XPA, W3XPC, Increase power to 40 w, add A3  
W3XP emission; change antenna and transmitter; and change area to Philadelphia, Pa. Washington, Philadelphia and New York.
- W3XPD, W3XPE, Change power to 40-w (peak)  
W3XPF, W3XPG visual, 40-w aural, change type of transmitter and antenna, extend commencement and completion dates of experimental relay station to 60 and 180 days, respectively, change areas to Central Maryland, N. E. Maryland, S. E. Pennsylvania and District of Columbia.  
W3XPH, W3XPI, W3XPK  
W3XPK Portable-mobile
- W3XPR Modify construction of new experimental television broadcast station to increase power to 40 w, add A3 emission, change area to Washington, Philadelphia and New York, change transmitter and extend commencement and completion dates to 60 and 180 days, respectively.  
New York, N. Y. Construct new experimental television relay broadcast station to be used with WPTZ.
- — — — —  
Portable-mobile
- WGY Operate with decrease in power and changes in transmitting equipment of auxiliary.  
Schenectady, N. Y.
- WMAZ Operate auxiliary transmitter and move to site of main transmitter with increase in power to 1 kw and use of DA for day and night operation.  
Macon, Ga.
- WEHS Extend completion date of new f-m broadcast station to July 8, 1945.  
Chicago, Ill.
- KOB Extend for 6 mo. operation on 770 kc, 25 kw night, 50 kw-ls, unlimited time.  
Albuquerque, N. M.  
KVSO Increase nighttime power from 100 to 250 w.  
Ardmore, Okla.

### BUSINESS NEWS

JEFFERSON-TRAVIS RADIO MFG. CORP., makers of communications equipment, and Fonda Corp., manufacturers of continuous sound recording equipment, are merged into the Jefferson-Travis Corp.

RAYTHEON MFG. Co. moves the New York offices of its radio receiving tube division from 420 Lexington Ave. to 60 East 42nd St.—the Lincoln Building, New York, N. Y.

BELMONT RADIO CORP., as agent of Defense Supplies Corp., takes over a plant containing 72,000 sq ft. of floor space to serve as a regional redistribution center for surplus military electronic and radio material.

PHILCO RADIO AND TELEVISION CORP. has formed a new television broadcasting division which brings together all Philco telecasting activities including operation of

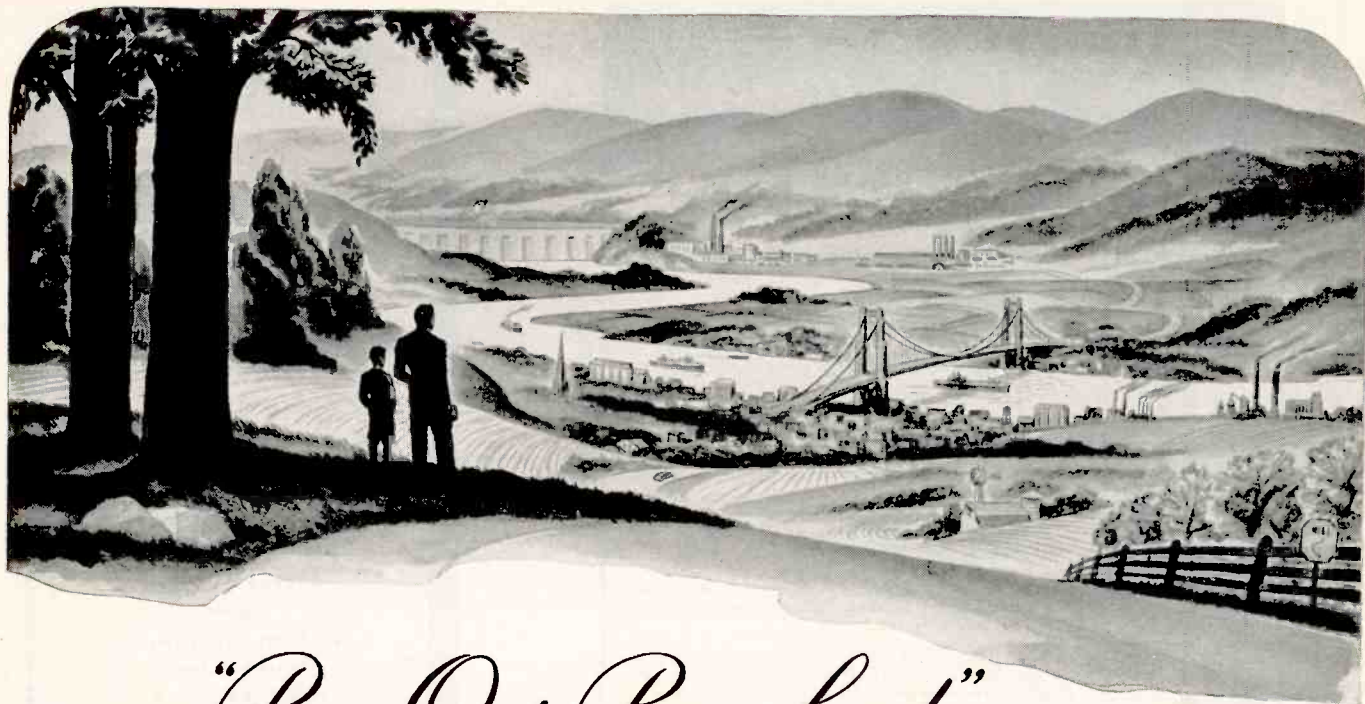

## "Ring Out, Brave Land"

### ...LET'S CREATE NEW MARKETS

Only by the creation of new markets, can we, as a nation, keep a high standard of living.

No longer is it sufficient to exploit only the existing markets, many of which are already worn thin. To create new markets should be the goal of all Industry—not only from a sense of duty to the peoples of this country, but from a plain common-sense dollars and cents viewpoint.

One of the best and surest ways to accomplish the most good for the nation—and more sales for the electric appliance industry—is the intensive development of our natural resources.

#### THE TVA PLAN HAS SHOWN THE WAY

It's hard to put TVA into words. It is not just the generation of electric power, nor flood control alone, or merely soil conservation. All these are a part of TVA—but basically it is the growth of a people and the growth of the soil they live on. It has metamorphosed a stunted region and backward people into a new economy—profitable both from a humane as well as a commercial standpoint.

Cheap electricity, a prime result of TVA, has been one of the important elements that have enabled the people of the TVA region to become prosperous and to lead a life more in keeping with the American way. And inevitably, it *created an entirely new market* for the sale of electrical appliances and machinery.

A market, for instance, that showed a 374% increase in the sale of electric ranges over the preceding year; water heaters by 774%, refrigerators by 329%! This, from a former undeveloped "poor market" area!

Every one of the electric farm machines, washers, refrigerators, ranges, radios and other appliances that went into the Tennessee Valley provided work and income for the dealers, distributors and service men who sold, installed and maintained them; jobs and profits for the workmen and manufacturers who produced them—Yes and for you and us.

#### ESTABLISH A MISSOURI VALLEY AUTHORITY

Now that TVA has shown the way, what is more logical than to follow up with an MVA? The Missouri River Basin, about one-sixth of the land area of the nation, has problems similar to the Tennessee Valley. It presents a definite challenge to a forward-looking nation. *And an unprecedented profit opportunity for the manufacturers of electric machinery and appliances!*

So let us urge Congress to set up a Missouri Valley Authority to develop all the resources of this vast region for the benefit of all the nation. Let us urge Congress to act immediately, so that when the war is over, the plans will have been made, and we can go forward. For further information, send for free booklet.

*First of a series of advertisements designed to encourage the creation of new markets.*



**GENERAL TRANSFORMER CORPORATION**

1250 West Van Buren Street

Chicago 7, Illinois

FOR BETTER WIRE INSULATION

## Specify Walsco Flexitube

This high grade synthetic tubing has many special qualities which recommend it for all types of electrical insulation

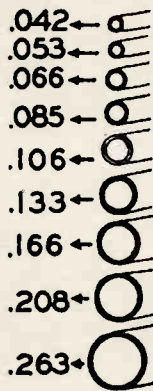

### WALSCO FLEXITUBE FEATURES

1. Extremely flexible.
2. Resistant to abrasion.
3. High dielectric strength.  
At room temperature Walsco Flexitube averages 15,000 volts, with a guaranteed minimum of 12,000 volts for all sizes.
4. Temperature resistant.  
Will not become hard or brittle under temperatures ranging from minus 35°C to plus 75°C.
5. Specification colors.  
Flexitube comes in stock colors of red, black, green and clear. Any other color can be supplied on very short notice.
6. Chemical and oil resistance.  
Flexitube is practically impervious to water, oils, grease, alcohol, hydro-carbons, alkalis and acids.

Superior Insulation for All Electrical Wiring—Radio, Radar, Electronic Controls, Electric Appliances, Automotive.

Actual Standard Sizes, other sizes made to order. Packaged in handy boxes or on long length spools. Also furnished in cut lengths, 1' up.

Write today for FREE WALSCO Catalog listing and illustrating over 500 other Walsco products, and for FREE Flexitube Sample Kit—Dept. E-1.

## WALSCO FLEXITUBE

Mfd. by WALTER L. SCHOTT CO.  
9306 Santa Monica Blvd. • Beverly Hills, California

## TERMINALS FOR ELECTRIC WIRES

Condenser Plates  
Small Metal Stampings  
in accordance with  
Customer's Prints

- ACCURACY
- PRECISION
- REASONABLE DIE CHARGES

Modern Equipment and Factory  
NO SCREW MACHINE PARTS

## PATTON-MACGUYER COMPANY

17 VIRGINIA AVE.  
PROVIDENCE, R. I.



THERMOSTATIC METAL-TYPE

## DELAY RELAYS

PROVIDE DELAYS RANGING FROM 1 TO 120 SECONDS

Other important features include:—

1. Compensated for ambient temperature changes from -40° to 110°F.
2. Contact ratings up to 115V-10a AC.
3. Hermetically sealed — not affected by altitude, moisture or other climate changes . . . Explosion-proof.
4. Octal radio base for easy replacement.
5. Compact, light, rugged, inexpensive.
6. Circuits available: SPST Normally Open; SPST Normally Closed.

WHAT'S YOUR PROBLEM? Send for "Special Problem Sheet" and Descriptive Bulletin.

**AMPERITE CO.** 561 BROADWAY, NEW YORK 12, N. Y.

In Canada: Atlas Radio Corp., Ltd.  
560 King St. W., Toronto



Need WIRE Now?  
**COLUMBIA**  
Has It!

INSULATED ELECTRICAL WIRE

GAUGES

#22 TO #12



IMMEDIATE DELIVERY FROM LARGE STOCK

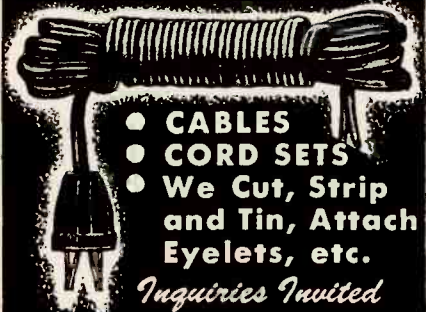

- CABLES
- CORD SETS
- We Cut, Strip and Tin, Attach Eyelets, etc.

Inquiries Invited

**COLUMBIA WIRE & SUPPLY CO.**  
4110 N. PULASKI ROAD  
CHICAGO 41, ILLINOIS





HERMETICALLY  
SEALED  
WEIGHT: 1¼ OUNCES  
MOUNTS IN A  
1" PANEL OPENING

## MB MAKES THEM . . .

the smallest millivoltmeters — voltmeters — ammeters  
milliammeters and microammeters

*for Aircraft and  
Portable Equipment*

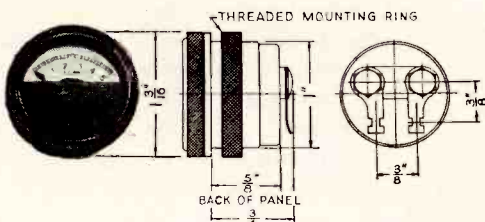

Mounting Dimensions — model 100

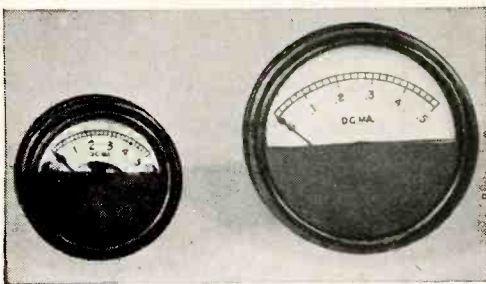

MB Miniature Ammeters  
—at left, 1 inch diameter, model 100;  
—at right, 1½ inch diameter, model 150.

**T**INY ENOUGH to fit into the smallest space, this unusual new MB series of electrical indicating instruments, will meet most exacting, rigid tests for accuracy, performance and durability. They are hermetically sealed in a rugged anodized aluminum case which, in turn, can be sealed to the mounting panel itself. Wherever space and weight in electrical indicating instruments are at a premium, this new MB series is the answer.

In addition to the one inch meter, MB also makes a one and one half inch meter, weighing one and one half ounces, with the same type of construction and offering the same advantages.

Write for new catalog to Dep't. E, The MB Manufacturing Company, Inc., Instrument Division, 250 Dodge Avenue, East Haven 12, Connecticut.

**THE MB MANUFACTURING COMPANY, INC.**

INSTRUMENT DIVISION

250 DODGE AVENUE, EAST HAVEN 12, CONN.

*Better  
and Better*

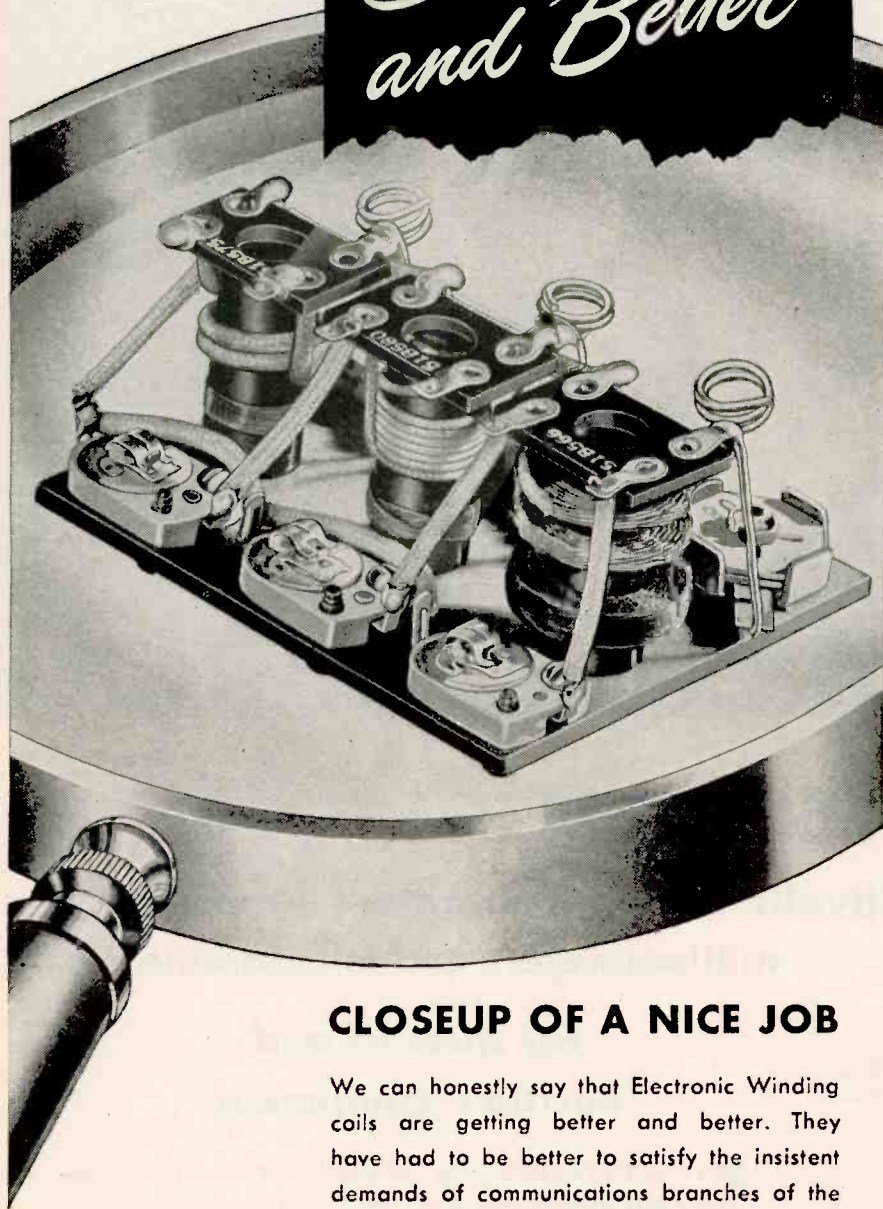

### CLOSEUP OF A NICE JOB

We can honestly say that Electronic Winding coils are getting better and better. They have had to be better to satisfy the insistent demands of communications branches of the armed services and to contribute to the dependability of rugged radio equipment that is helping to save lives all around the world. This closeup of a nice job of coil winding shows a complete RF assembly — just one of the many precise jobs we can do. If specifications call for a coil of extra quality call on Electronic Winding.

# Electronic Winding Co.

5031 BROADWAY  
CHICAGO 40, ILL.

★ ★ MANUFACTURERS OF EXTRA  
QUALITY COILS FOR PRECISION  
COMMUNICATIONS EQUIPMENT

Station WPTZ and the new television network between Washington and Philadelphia.

RADIO CORP. OF AMERICA is working under a unique manpower sharing plan with Prudential Insurance Co. at Newark, N. J. RCA has installed a production operation on the premises of the insurance company and employs a group of the



company's personnel for part-time operation. The illustration shows a view of the 40 Prudential girl typists and clerks who are working in two shifts of four hours each on a simple assembly operation for miniature electron tubes.

### PERSONNEL

HARRY C. INGLES, major general, Chief Signal Officer of the Army, was presented with an honorary degree of doctor of engineering by the trustees of the University of Nebraska for his outstanding accomplishments in the field of communications engineering.

RALPH R. BEAL, assistant to the vice president in charge of RCA Laboratories and for nine years research director of RCA, becomes vice-president of RCA Communications Inc. in charge of engineering.

GEORGE T. BROWNELL, signal officer and lieutenant colonel in the 11th armored division, is made chief engineer of the Majestic



YOU CAN PROFIT FROM OUR KNOW-HOW ON  
**MICROPHONES**

NOISE CANCEL  
DIFFERENTIAL MICROPHONES  
BOOM LIP MICROPHONES  
CRYSTAL MICROPHONES  
MAGNETIC MICROPHONES  
DYNAMIC MICROPHONES  
CARBON MICROPHONES

NO REJECTS WITH COMPONENTS BY AVIOMETER

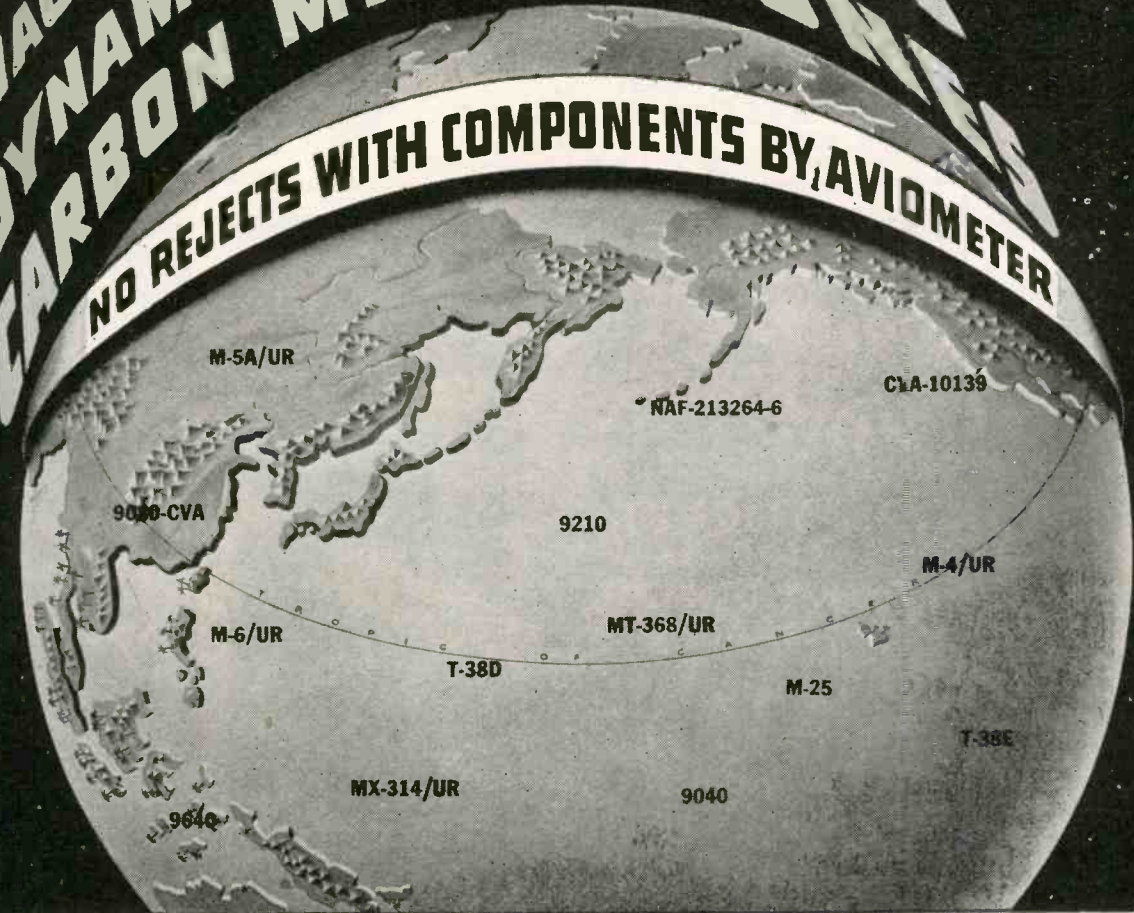

**AVIOMETER**

COMMUNICATION AND CONTROL INSTRUMENTS  
370 WEST 35TH STREET NEW YORK 1, N. Y.



SO SMALL YOU CAN HARDLY SEE THEM  
yet PERFECT IN EVERY DETAIL

Invaluable in the fields of electronics, radio and fine instruments, are these "UNBRAKO" SELF-LOCKING SOCKET SET SCREWS—now made in such extremely small sizes that you can hardly see them.

The knurled cup—point of this unique "Unbrako" Socket Set Screw digs-in, holds tight, and makes it a *Self-Locker*. Vibration positively will not loosen it, yet it is easily removed with a wrench and may be used over and over again. Sizes from #0 to 1" diameter—all commercial lengths.

Knurling of Socket Screws originated with "Unbrako" years ago.

Where the Knurled Cup Point "Unbrako" cannot be used, use our Knurled Thread "Unbrako"—also a Self-Locker regardless of the style of point.

Write for the Catalog of "Unbrako" Socket Screw Products.  
OVER 40 YEARS IN BUSINESS

**STANDARD PRESSED STEEL CO.**  
JENKINTOWN, PENNA. BOX 596  
Boston • Detroit • Indianapolis • Chicago • St. Louis • San Francisco



**UNBRAKO**

Reg. U.S. Pat. Off.  
SELF-LOCKING  
HOLLOW SET SCREW



**KIRKLAND Pioneer**  
INDICATING LAMPS

WHERE QUALITY IS THE  
FOREMOST CONSIDERATION



**THE #659 D/E DELUXE-UNIT  
OF SUPERIOR DESIGN  
AND CONSTRUCTION**

*Extremely Shallow in Depth  
1 1/4" Behind Front of Panel*

Heavy walled glass lens in a screw type lens-cap, 1/8" thickness hex holding lip, 1 3/8" mounting hole, molded socket with 6/32 screw terminals. For 56 lamps up to 120 volts, lamp easily removed from the front without tool. List Price (less bulb) \$2.20.

WRITE FOR CATALOGUE

**THE H. R. KIRKLAND CO.**  
MORRISTOWN, N. J.

**INVESTIGATE**

*Franklin's* **39**

**RADIO SOCKET**

*The favorite yesterday, the favorite for tomorrow*

**NORMAN H.**

**LAWTON**

Engineering • Sales • Service  
1775 Broadway, New York City, 19  
Phone Circle 6-0867



Note—Ground Tab

Illustrating the "U" shaped low action contacts, 3/4" and 1/2" in Franklin's series 39 Sockets.

Low spring action maintains resiliency even after installation of wire pins.

Direction of metal grain prevents breaking of soldering tab and permits rough handling in production.



"U" shaped contact provides separate soldering tab which prevents solder from flowing into contact body.



The 3/90 contact has a soldering tab to eliminate wiring to ground. Can be inserted in any position where grounding is desired.

MADE BY  
*Engineers*  
FOR *Engineers*

it won't  
be long  
**NOW**

**WIRES**

**cornish**  
WIRE COMPANY, INC.

**CORWICO**

15 Park Row,  
New York City



## Save Chassis Space with MALLORY "WB" CAPACITORS

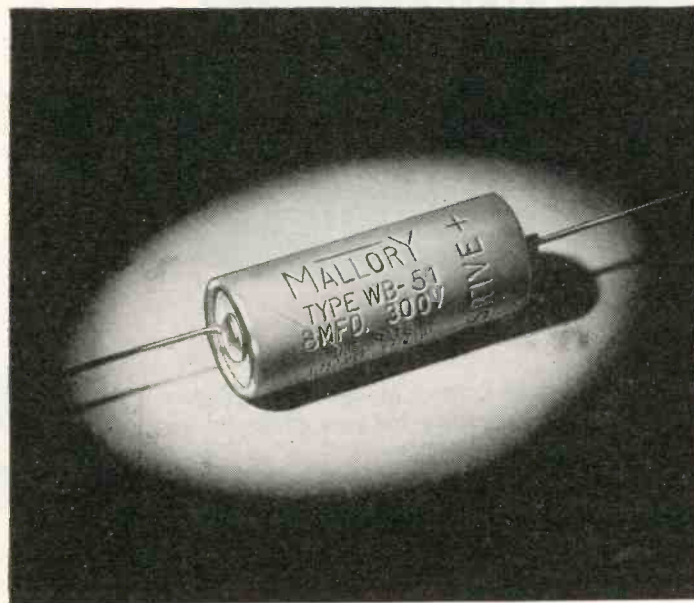

**W**HEREVER chassis space has to be figured in fractions of an inch... in small AC/DC receivers, for instance . . . you'll be wise to specify Mallory "WB" Capacitors. These dry electrolytics are designed and built to combine top efficiency with minimum size for their capacity rating.

To prevent moisture absorption, loss of electrolytic, and to withstand destructive temperature changes, each "WB" capacitor is hermetically sealed in an aluminum case and is covered with a waxed cardboard tube that avoids shorting in crowded installations.

End-sealing wax has been eliminated to reduce the length still further.

Mallory "WB" Capacitors are available from stock in rated capacities from 10 mfd. at 25 volts to 16 mfd. at 450 volts.

The Mallory catalog, listing characteristics of "WB's" and other Mallory precision capacitors, variable and fixed resistors, switches, vibrators, rectifiers and other electronic parts, is available *free* from your nearest Mallory Distributor. Ask him for a copy, or write us today.

**P. R. MALLORY & CO., Inc., INDIANAPOLIS 6, INDIANA**



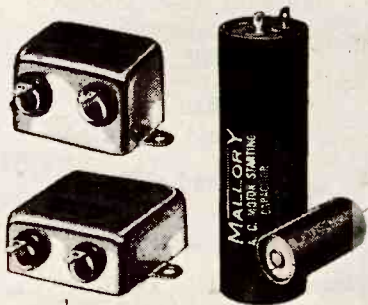

P. R. MALLORY & CO. Inc.

# MALLORY

## Electrolytic, Film and Paper CAPACITORS

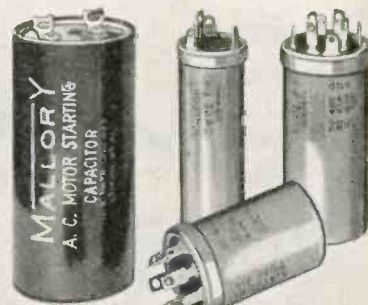



## SOLID AND LAMINATED PRECIOUS METALS FOR NEW INDUSTRIAL USES

Radio and Radar... antenna tuners, wave guides and stabilizers... function at new high levels of efficiency because of laminated precious metal tubing and solid coin silver tubing.

The entire Electrical Industry has been quick to recognize the fact that laminated precious metal tubing maintains delicate electrical properties without variance under any climatic or atmospheric conditions. It is therefore ideal for electronic applications, high frequency radio parts and delicate instrument assemblies.

Gold, silver, platinum and palladium or special precious metal alloys laminated to base metal have made these things possible...

- The desirable electrical, mechanical or chemical qualities of the precious metals have been added to the strength or other desirable properties of base metals, precisely where and as required.
- Precious metal properties of corrosion resistance, electrical superiority, and durability are obtained without solid precious metal costs.
- Uniform maintenance of lamination ratios with no porosity, pit marks or defects.
- Finer, more lasting finishes than are otherwise obtainable in base metals.

Almost every conceivable shape of tubing may be had. Rings, sleeves and jackets are quickly and economically cut from laminated tubes. Machining and forming operations can often be eliminated or reduced by the use of specially shaped tubing.

To assist you in the application of our products to your products we are maintaining a staff of thoroughly experienced metallurgists, chemists, designers and consultants... an up-to-date research and testing laboratory... and a splendidly equipped tool room. These are all at your service to cooperate with your own staff to the full extent of our facilities.

Your inquiries are cordially invited. Ask, too, for a copy of our new descriptive folder.



*Makepeace* PRODUCTS

SHEETS • WIRE • TUBING • SOLDERS  
FABRICATED PARTS AND ASSEMBLIES

**D. E. MAKEPEACE COMPANY**

Main Office and Plant, ATTLEBORO, MASS.

New York Office, 30 Church St.

Radio & Television Corp., St. Charles, Ill.

HARVEY W. SMITH, electrical engineer specializing in transformer design, joins the engineering staff of Glenn-Roberts Co., Oakland, Calif. He will head the research and development activities of the company.

STANFORD C. HOOPER, father of navy radio and consulting engineer for Automatic Electric Co., Chicago, Ill., receives the Franklin Institute's Elliott Cresson Medal for 1945. Admiral Hooper was selected for his pioneering leadership in the field of radio for the United States Navy. In the accompanying illus-



tration he is receiving the award from Charles S. Pelling, president of Franklin Institute, center, who presented at the same ceremony the Franklin Medal to Dr. Harlow Shapley, director of Harvard College Observatories and professor of astronomy, for his work in that science.

### AWARDS

Workers of the following concerns in the electronics field have been awarded Army-Navy burgees for excellence in production:

Induction Heating Co.  
New York, N. Y.

International Detrola Corp.  
Detrola Radio Div.  
Detroit, Mich.

Machlett Laboratories,  
Power Tube Division  
Norwalk, Conn.

Pilot Radio Corp.  
Long Island City, N. Y.

Rauland Corp.  
Plants No. 1, 2, 3, and 4  
Chicago, Ill.

Sylvania Electric Products, Inc.  
Wakefield, Mass.

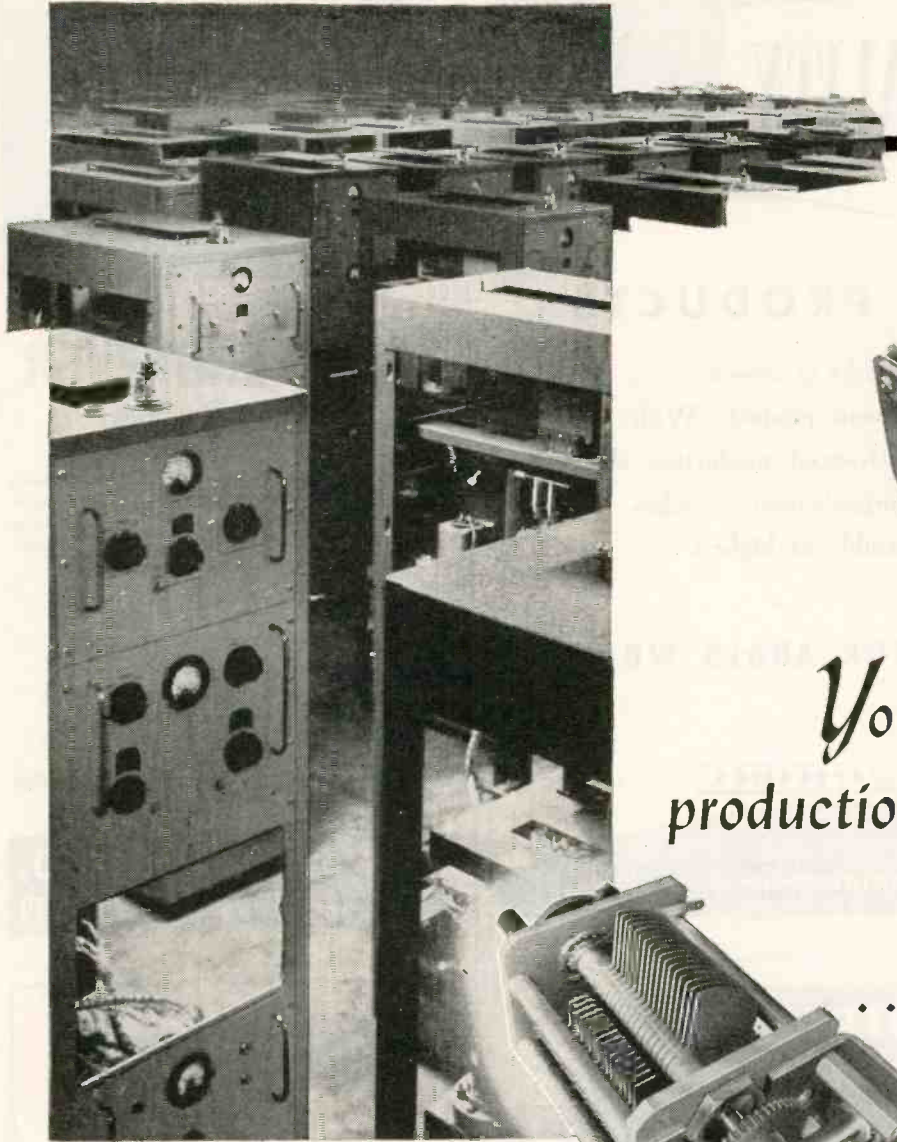

**ONE- TO FOUR-SECTION FIXED CAPACITORS.** Designed for the output section of a pi-network, this compact, multiple capacitor eliminates the need for mica-type units. Typical capacities are 20, 40, 120 and 230 mmf. It has mycalex insulation throughout and all sections are common on one side. Complete tooling makes fast delivery possible.



*You can break  
production bottlenecks with  
these components  
... Techrad designed  
and built  
them for that  
specific purpose*

**VARIABLE CONDENSER.** To fill a need for precision variable condensers, Techrad designed and built one with the following features: ball bearings, pyrex glass insulation, sodered plates, .030" spacing, worm, anti-backlash drive assembly and lead-screw stop arrangement.

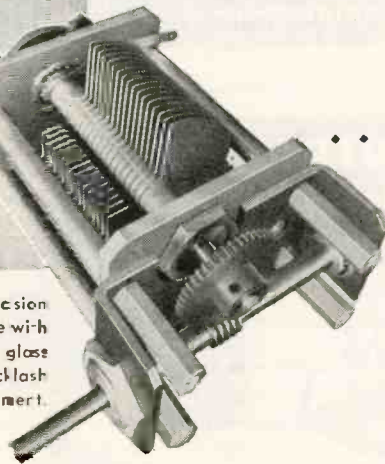

**technical radio company**

275 NINTH STREET • SAN FRANCISCO 3, CALIFORNIA

EXPORT AGENTS: FRAZAR & HANSEN, 301 CLAY STREET, SAN FRANCISCO 11, CALIFORNIA, U. S. A.

*Over a decade of continuous experience*

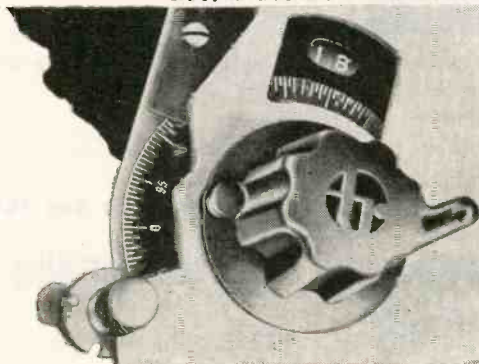

**INTERPOLATING COUNTERDIAL.** Swift, sure and accurate calibration. By giving an accurate log of any position it makes possible the exact return to any previously established setting. Mechanically simple, there are no parts to get out of adjustment; no back-lash because the dial is coupled directly to the driven apparatus. Standard stock counters have two digit number (0 to 99). Used by Techrad on variable condensers and roller inductors.

**DIAL LOCK,** for use with flat disc dials of various thicknesses. Simply constructed, it employs the established right-hand, left-hand thread principle. No dragging or scraping when dial is disengaged. It is impossible to distort or bend the dial scale when locked. Hairline accuracy of setting is maintained when dial is locked because the two locking discs do not rotate.

WRITE FOR COMPLETE INFORMATION AND DATA ON TECHRAD COMPONENTS

FOR **QUALITY**

## RADELL-BUILT PRODUCTS

• It is easy to recognize the marks of superior craftsmanship in Radell-built electronic products. With a broad basic knowledge and advanced production skill, Radell Corporation is a versatile organization specializing in the assembly and sub-assembly of highest quality electronic products.

COMPLETE FACILITIES FOR AUDIO WORK

# RADELL CORPORATION

6323-37 Guilford Avenue, Indianapolis 5, Indiana

## EISLER EQUIPMENT

..complete and diversified for every phase of electronic\* manufacture!



(A) No. 600-KC3P, 50 KVA Press Type Spot Welder, 3 Spots, Air Operated, 18" Throat—a high production unit.

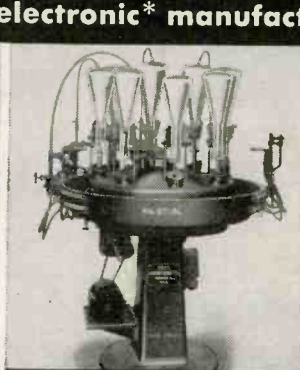

(B) No. 57-8L New Eisler 8 head type Tipless Sealing Machine. Adaptable for all types and sizes of bulbs.

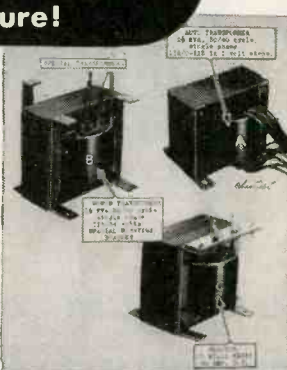

(C) EISLER Special Transformers and Reactors—high or low voltage; air cooled, oil immersed or uncased.

The CHAS. EISLER line of specialized electronic tools, machines and devices is complete and diversified. Included are innumerable types of welders—spot, seam, butt, rocker, arm, pneumatic and special types. Also included are hundreds

of devices for vacuum tube manufacture—glass tube cutters, slicers, stem and sealing machines as well as an all-inclusive line of transformers for every industrial and general need.

\* EISLER serves 99% of American vacuum tube producers today. Write for completely illustrated catalog now—you incur no obligation.

Chas. Eisler  
**Eisler**

**ENGINEERING COMPANY**

751 SO. 13th STREET NEWARK 3, NEW JERSEY

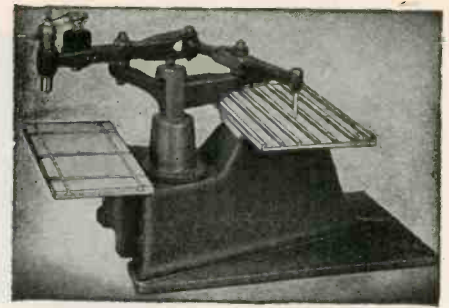

DUPLICATING and PROFILING

## AUTO ENGRAVER

*Accurate Engraving  
with Unskilled Operators*

Unskilled operators will profile or accurately reproduce in smooth lines any design, number, letter, emblem, signature; on iron, brass, copper, aluminum, soft steels and all plastics. Here are some of its other uses . . .

- Drills a series of holes, or profiles small parts.
- Cuts an even channel for wiring on panels. Increases accuracy and production.
- Works from original drawing or templates.
- Etches glass and similar items.
- Will not cause distortion.

For complete information on this and other models and prices write Dept. K

**AUTO ENGRAVER CO.**  
1776 BROADWAY, NEW YORK 19

## ACOUSTIC ENGINEER

## TO DEVELOP LOUD SPEAKERS

Familiar with laboratory and measurement devices for checking loud speaker characteristics.

Right hand man to chief engineer. Permanent, post-war position with rapidly-growing loud speaker manufacturer located in New York City

Salary commensurate with qualifications

*Submit complete resume*

**Write to Box 354**

**Cromwell Advertising Agency**  
INCORPORATED

122 E. 42d St., New York 17



# 106-A SERIES

# Amplifiers

WITH MOUNTING ACCESSORIES

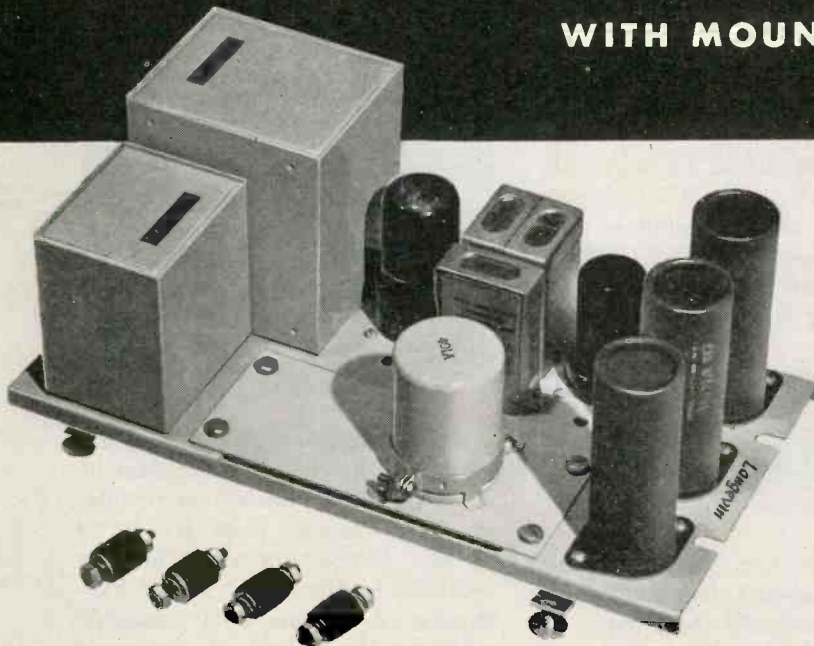

The TYPE 106-A AMPLIFIER is a two-stage medium fixed gain preamplifier, designed for use in high quality broadcast-speech-input or sound systems. The low noise level generated within the amplifier and its excellent frequency response make it particularly desirable. It is small in size. Three 106 amplifiers can be mounted in a 10½" rack space. It requires an external power supply such as the Langevin 201-B.

## ELECTRICAL CHARACTERISTICS

GAIN—Approximately 39 db with provisions for decreasing to 29 or 19 db maximum.

OPERATES FROM—Source impedance of 30/250/600 Ohms.

OPERATES INTO—Load impedance of 600 Ohms.

OUTPUT POWER—+16 dbm with less than 1% total R.M.S. harmonic distortion at 400 cycles single frequency.

OUTPUT NOISE—The unweighted noise generated within the 106-A amplifier is equivalent to an input signal of -119 dbm (db below .001 Watts) over a band width of 20,000 cycles.

FREQUENCY CHARACTERISTIC—Production run  $\pm .5$  to 1 db over the range 30-15000 c.p.s.

METERING CIRCUITS—Designed for plate current reading on a percentage type meter.

POWER REQUIREMENTS—FILAMENT 6.3 Volts, .6 Amperes. PLATE 275 Volts, 8 Milliamperes.

The type 3A mounting frame, requiring 10½ inches rack space, will accommodate up to THREE 106 Series Amplifiers and is suitable for wall mounting cabinet or rack and panel installations.

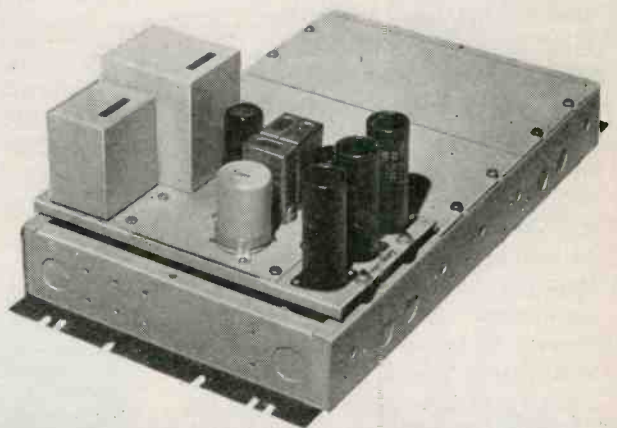

# The Langevin Company

INCORPORATED

SOUND REINFORCEMENT AND REPRODUCTION ENGINEERING

NEW YORK

37 W. 65 St., 23

SAN FRANCISCO

1050 Howard St., 3

LOS ANGELES

1000 N. Seward St., 38

# NEW PRODUCTS

Month after month, manufacturers develop new materials, new components, new assemblies, new measuring equipment; issue new technical bulletins, and new catalogs

## High-Sensitivity Resistors

G. M. GIANNINI & Company (161 E. California St., Pasadena, Calif.) state that their autoflight high-sensitivity resistors are the first of their kind to be built in the United States. Overall dimensions of the components are  $1\frac{1}{4} \times 1\frac{1}{8}$  in. diameter and they are capable of producing from a low-torque rotational movement a variable electric resistance. They can be connected directly to sensitive low-torque apparatus such as aircraft flight test

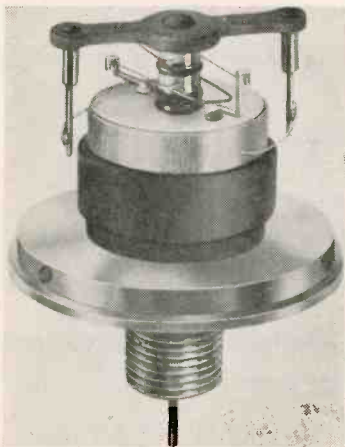

recording instruments and will operate relays or recording systems without the use of amplifiers, and from a simple d-c source. The manufacturer also states that their development is a step forward toward the simplification of delicate circuit measurements, particularly in laboratory or industrial applications where photoelectric cells and amplifiers are required. Units come in various sizes from 100 to 1500 ohms, and from 4 to 15 watts. Only 2 gram-millimeters input torque to overcome friction is required. This low value is secured by use of a jewel-supported shaft, the contact mechanism being made with the accuracy of a fine watch.

## Metal Tube-Shield

MODEL J-583 shield, for 5-in. cathode-ray tubes, meets Navy requirements for shock resistance. The shield is constructed of 0.025-in. Mu-metal and is hydrogen annealed at 1100 deg C to achieve magnetic

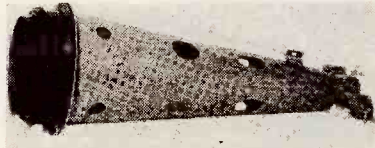

shielding. A rear clamp grips both the tube base and the socket of the tube so as to hold them firmly together at all times. For added shock protection the shields have sponge-rubber linings on the clamp and between the shield hood and the tube face. The shield is easily removed from tubes, when necessary. Metallic Arts Co., 243 Broadway, Cambridge 39, Mass.

## Signal Generators

TWO NEW signal generators (Types SG-2A and SG-3A) and a new multi-range measuring instrument (Type UM-4) have been announced by the Specialty Div., General Electric Company's Electronics Department, Schenectady, N. Y. Type SG-2A generator provides a signal source only, the other (SG-3A) gives calibrated output readings. On fundamental frequencies SG-2A covers a range of 100 kc to 32



Mc in five bands which are selected on the front panel. Modulation of the unit (30 percent in accordance with IRE recommendations for receiver testing) is effected by the constant-current method on the plate of the oscillator tube. Changes in line voltage and attenuator settings do not affect the frequency of the instrument. Type SG-3A gives

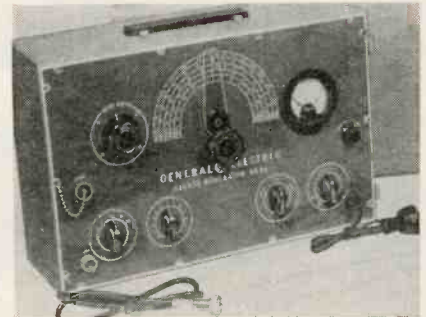

directly calibrated readings of r-f output, with subdivided readings of signals of 0.5 to 100,000 microvolts, at all frequencies from 100 kc to 32 Mc. Signals up to 64 Mc are available by the use of second harmonics. A vacuum tube voltmeter monitors the output of the modulated oscillator to the attenuator while a panel control is used to maintain a constant level. Five complete reading scales are possible.

Type UM-4 Unimeter can be used



in cathode-ray tube and television high voltage uses, as well as in industrial and radio maintenance where voltage, current and resistance measurements are required. Safety protection on the meter is provided for the operator. On d.c. the unit operates from zero to 10,000 volts at 20,000 ohms per volt. On a-c ranges it operates from zero to 10,000 volts at approximately 5000 ohms per volt. Direct-current ranges extend from 100 microamp

*Meet*  
**TWO LITTLE METERS**  
**THAT DO A GREAT BIG JOB!**



**EXTERNAL PIVOT INSTRUMENTS**

**1½" Square Model 112**

Measuring only 1¾" square by 25/32" deep, the 112 is capable of performing a full-scale task in a variety of applications. Made with the precision of all DeJUR larger instruments. It can be immersed in water at a depth of 30 feet for seven days without harm to mechanism. Movement built to forthcoming JAN-I-6 specification for 1½ inch instruments. Quickly and easily installed. Additional information upon request.

**1½" Round Model 120**

Another good friend to know. It also is capable of doing a man-sized job in many applications where space is at a minimum. Performs with high efficiency. Uses basically the same carefully designed components as large DeJUR instruments. Built with fine precision. Entirely self-contained, with built-in resistors and shunts. Also, immersion-proof throughout. Conforms to forthcoming JAN-I-6 specifications for 1½ inch instruments. Write for catalog.

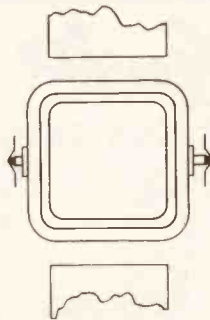

External Pivots

**EXTERNAL PIVOTS**—used in the design of DeJUR 1½ inch Meters provide greater accuracy in mounting the moving element between the jewel bearings. For this reason internal pivots are not used in DeJur instruments.

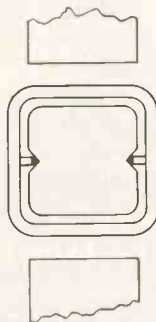

Internal Pivots

DeJUR engineers are prepared to work with you on special models of DeJUR Products for your present and postwar applications.



**DeJUR** AMSCO CORPORATION

GENERAL OFFICE: NORTHERN BLVD. AT 45th STREET, LONG ISLAND CITY 1, N. Y

## The "All-Weather" Resistors

**TYPE 65X**

Actual Size  
Other types available in  
the lower values

**RESISTOR BULLETIN 4505  
GIVES FULL DETAILS . . .**

It shows illustrations of the different types of S. S. White Molded Resistors and gives details about construction, dimensions, etc. A copy, with Price List will be mailed on request. Write for it—today.

**S.S. WHITE**

THE S. S. WHITE DENTAL MFG. CO.



**WIDELY FAVORED** because of  
**NOISELESS** operation, **DURABILITY**  
and fine **PERFORMANCE** in  
all climates . . .

**STANDARD RANGE**  
1000 ohms to 10 megohms  
**NOISE TESTED**

At slight additional cost, resistors in the Standard Range are supplied with each resistor noise tested to the following standard: "For the complete audio frequency range, resistor shall have less noise than corresponds to a change of resistance of 1 part in 1,000,000."

**HIGH VALUES**

15 megohms to  
1,000,000 megohms

**INDUSTRIAL DIVISION**

DEPT. 10, 10 EAST 40th ST., NEW YORK 18, N. Y.  
FLEXIBLE SHAPES      AIRCRAFT ACCESSORIES  
MOLDED RESISTORS      FLEXIBLE SHAPES

One of America's AAA Industrial Enterprises

**Immediate Delivery!**

**WIDE RANGE  
VACUUM TUBE  
VOLTMETERS**

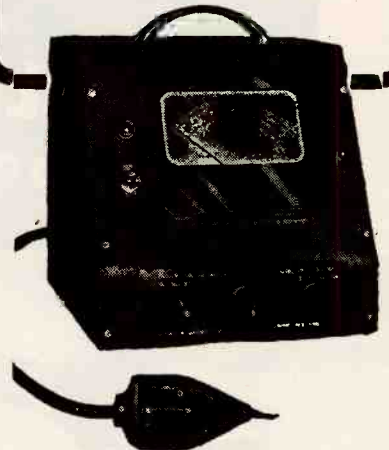

- High input impedance for both AC and DC measurements.
- Convenient, low capacity "Probe," especially adapted to high frequency radio use—100 megacycles and over.
- Self-regulating operation from power line; no batteries.
- Multiple voltage ranges—accurate and stable.

**BULLETIN ON REQUEST**

**ALFRED W. BARBER  
LABORATORIES**

34-06 Francis Lewis Blvd. Flushing, N. Y.



LONG LIFE

**The Extra Value  
is in the Extra Life**

Yes, PERMOPIVOTS last lots longer. They multiply the accurate life of precision instruments! It's the precious metals (osmium alloy) tip that does it.

PERMOPIVOTS, wear resistant . . . non-abrasive . . . non-corrosive . . . non-magnetic. PERMOPIVOTS: perfect!

Write for literature

For  
Precision  
Instruments

**PERMO** INCORPORATED

Manufacturing Metallurgists

6427 Ravenswood Ave., Chicago 26

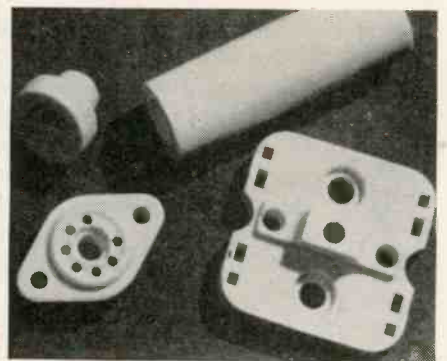

**Lavite** STEATITE  
CERAMIC

Properties and Characteristics of Our  
LAVITE S1-5 Steatite Ceramic Body

Compressive Strength . . . . .	95,000 lbs. per square inch
Tensile Strength . . . . .	7,200 lbs. per square inch
Flexural Strength . . . . .	10,500 lbs. per square inch
Modulus of Rupture . . . . .	20,000 lbs. per square inch
Dielectric Strength . . . . .	235 volts per mil

Dielectric Constant . . . . .	6.42	} Frequency of
Loss Factor . . . . .	2.90	
Power Factor . . . . .	4.46	

Bulk Specific Gravity . . . . .	2.664%
Density (from above gravity) . . . . .	0.096 lbs. per cubic inch
Hardness (Mohr scale) . . . . .	7.0
Softening Temperature . . . . .	2,350°F.
Linear Coefficient of Expansion . . . . .	5.13x10 <sup>-6</sup>
Moisture Absorption (ASTM D-116-42-A) . . . . .	0.009%

Makers of electrical and radio apparatus destined for war service are finding in LAVITE the precise qualities called for in their specifications . . . high compressive and dielectric strength, low moisture absorption and resistance to rot, fumes, acids, and high heat. The exceedingly low loss-factor of LAVITE plus its excellent workability makes it ideal for all high frequency applications.

We will gladly supply samples for testing.

**D. M. STEWARD MFG. COMPANY**

Main Office & Works Chattanooga, Tenn.  
Needham, Mass. Chicago Los Angeles

# FOR QUICK VISUAL INDICATION

Investigate the Unique Characteristics of G-E Neon Glow Lamps

● The unique characteristics of General Electric Neon Glow Lamps recommend them for a variety of uses in radios and electronic devices . . . as indicators, voltage regulators, pilot lights and test lamps.

The uses described at right are typical. If you think G-E Neon Glow Lamps can be useful to you, write or phone the address below. Experienced General Electric Lamp Engineers will be glad to discuss your problems with you.

## CONSIDER THESE ADVANTAGES

1. Distinctive orange-red glow—no colored cover glass needed.
2. Dependable performance and long life—rated at 3,000 hours.
3. Very low current consumption—less than 1/2 milliamperes for smallest lamp.
4. Variety of sizes and wattages.
5. High resistance to vibration, shock.
6. Normally usable on a-c or d-c.
7. Screw base lamps for 105-125 v. circuits; similar lamps available with bayonet bases, but external resistance required.
8. Produce practically no heat.
9. Nearly flat volt-ampere characteristics.
10. Insensitive to voltage variations above critical value.



**NE-51** For general indication, such as showing existence of potential across various parts of electrical circuits.

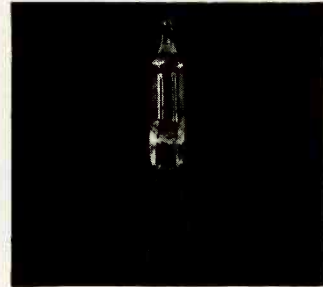

**NE-2** One of the most widely used indicator and test lamps—popular because of compactness and small size. Nominal wattage is only 1/25 watt. This lamp is unbased—has wire terminals.



**NE-48** (also NE-16). Indicator lamps. Special volt-ampere characteristics of these lamps indicate use as voltage regulators. Screw base lamp available as NE-45.\*



**NE-17** Indicator and pilot light lamp that flashes to show condition of B-battery in portable radios. Frequency of flashes decreases as battery runs down.

\*NE-16 meets JAN-1A specifications for 991. Special marking JCG-991 supplied for small extra charge.

ORDER NO.	NE-2	NE-51	NE-17	NE-48	NE-18	NE-45	NE-30	NE-32	NE-34	NE-36	NE-40	NE-42
Watts, Nominal	1/25	1/25	⊙	1/4	1/4	1/4	1	1	2	2	3	3
Volts (Circuit)	105-125	105-125	⊙	105-125	105-125	105-125	105-125	105-125	105-125	105-125	105-125	105-125
Starting Voltage ⊙	85 90	85 90	⊙	85 90	⊖	85 90	60 85	60 85	60 85	60 85	60 85	60 85
Base	★Unbased (Wire Terminals)	★S. C. Bay. Min.	★D. C. Bay. Cand.	★D. C. Bay. Cand.	★D. C. Bay. Cand.	Cand. Screw	Medium Screw	★D. C. Bay. Cand.	Medium Screw	★Sk. D. C. Bay. Cand.	Medium Screw	★Sk. D. C. Bay. Cand.
Maximum Overall Length	⊙ 1 1/16"	1 1/4"	1 1/2"	1 1/2"	1 1/2"	1 3/4"	2 1/4"	2"	3 1/4"	3 3/4"	3 3/4"	3 3/4"
List Price (plus tax)	\$ .08	\$ .10	\$ .45	\$ .35	\$ .42	\$ .40	\$ .40	\$ .45	\$ .50	\$ .55	\$ .60	\$ .65

⊙ Applies to lamp when new.

⊙ Glass part; wire terminals extend additional 1/16".

⊙ Designed for DC flashing operation in RC circuit.

⊙ Meets JAN-1A specifications for 991. Special marking JCG-991 supplied at small extra charge.

⊙ Designed for 67-87 Volts D.C. (D.C. operating voltage at 1.5 milliamperes, 53-85 volts).

★ All Bayonet Base Lamps Need External Resistance.

For further information, write address below for Bulletin 7100

NELA SPECIALTY DIVISION LAMP DEPARTMENT

# GENERAL ELECTRIC

1 Newark Street, Hoboken, N. J.

**ASK OUR ENGINEERS  
ABOUT  
POWER**

**GET THE EQUIPMENT  
BEST ADAPTED TO  
YOUR NEEDS**

**I**NDUSTRIAL Electronic Power is a familiar subject to our long experienced power engineers. They are eminently qualified to suggest the installations best suited to your needs. So . . . don't take chances. Submit your power supply problems to W. J. Complete lines of constant voltage transformers, power supplies, inverters, converters, power plants, and variacs are kept in stock always! You can therefore depend upon us not only for speedier deliveries, but also for the type of installation that will prove most practical and efficient for you. The coupon below, mailed today, will quickly bring you interesting additional information.



to 10 amp in 6 steps, and resistance measurements are provided from 3000 ohms to 10 megohms in 5 steps.

**Thermostatic Switch**

THIS NEW DUAL cam-adjusted thermostatic switch (rated at 1500 watts, 115-230 volts) can be used for either or both a thermostat and a manual switch. It eliminates the necessity of an additional on and off switch and permits instant adjustment of the thermostat. It is designed for mounting on the bottom of electrically-heated equipment such as glue pots, hot plates,

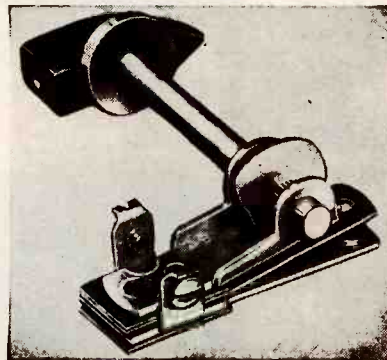

etc., where a manual on and off knob is desired. The knob which controls the temperature setting can be located any distance from the thermostatic element by lengthening the cam shaft. The unit is available in three adjustable temperature brackets: 50 to 300, 50 to 450, and 50 to 700 deg. F. George Ulanet Company, 88 E. Kinney Street, Newark, N. J.

**Open Blade Switch**

ILLUSTRATED below is a single-pole open-blade switch which is made of beryllium rolling springs. It is rated 15 amp, 115 volts a.c. Overall dimensions are 2 1/32 x 10/16 x 23/64 inches. Contact arrangements are for normally open, normally closed or double throw circuits. Standard operating pressure

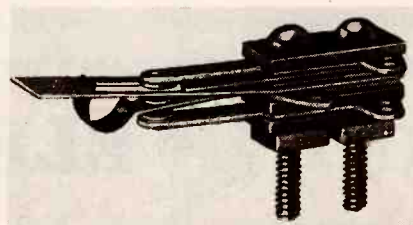

**BROADCASTING STATIONS!  
RECORDING STUDIOS!  
SCHOOLS!**

*You Can Get Them  
Without Delay!*



**GOULD-MOODY  
"Black Seal"  
GLASS BASE  
INSTANTANEOUS  
RECORDING BLANKS**

The tributes paid to "Black Seal" discs by many leading engineers have been earned by distinguished service on the turntable. Your ears will recognize the difference in quality of reproduction, and the longer play-back life will prove the superiority of "Black Seal" construction. Choice of two weights — thin, flexible, interchangeable with aluminum, or medium weight — both with four holes.

An AA-2X rating is automatically available to broadcasting stations, recording studios and schools. Enclosure of your priority rating will facilitate delivery. Old Aluminum Blanks Re-coated with "Black Seal" Formula on Short Notice.

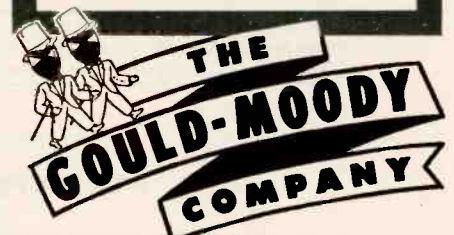

**RECORDING BLANK DIVISION  
395 BROADWAY • NEW YORK 13, N. Y.**

**EXPORT DEPT. ROYAL NATIONAL COMPANY, INC.  
89 BROAD STREET, N. Y.**

Please mail me free copies of voltage supply and control brochure and your new catalog.

NAME \_\_\_\_\_  
COMPANY \_\_\_\_\_  
CITY \_\_\_\_\_ ZONE \_\_\_\_\_ STATE \_\_\_\_\_

**WALKER-JIMIESON, INC.**  
311 SOUTH WESTERN AVE., CHICAGO 12, ILL.  
Phone CANal 2525

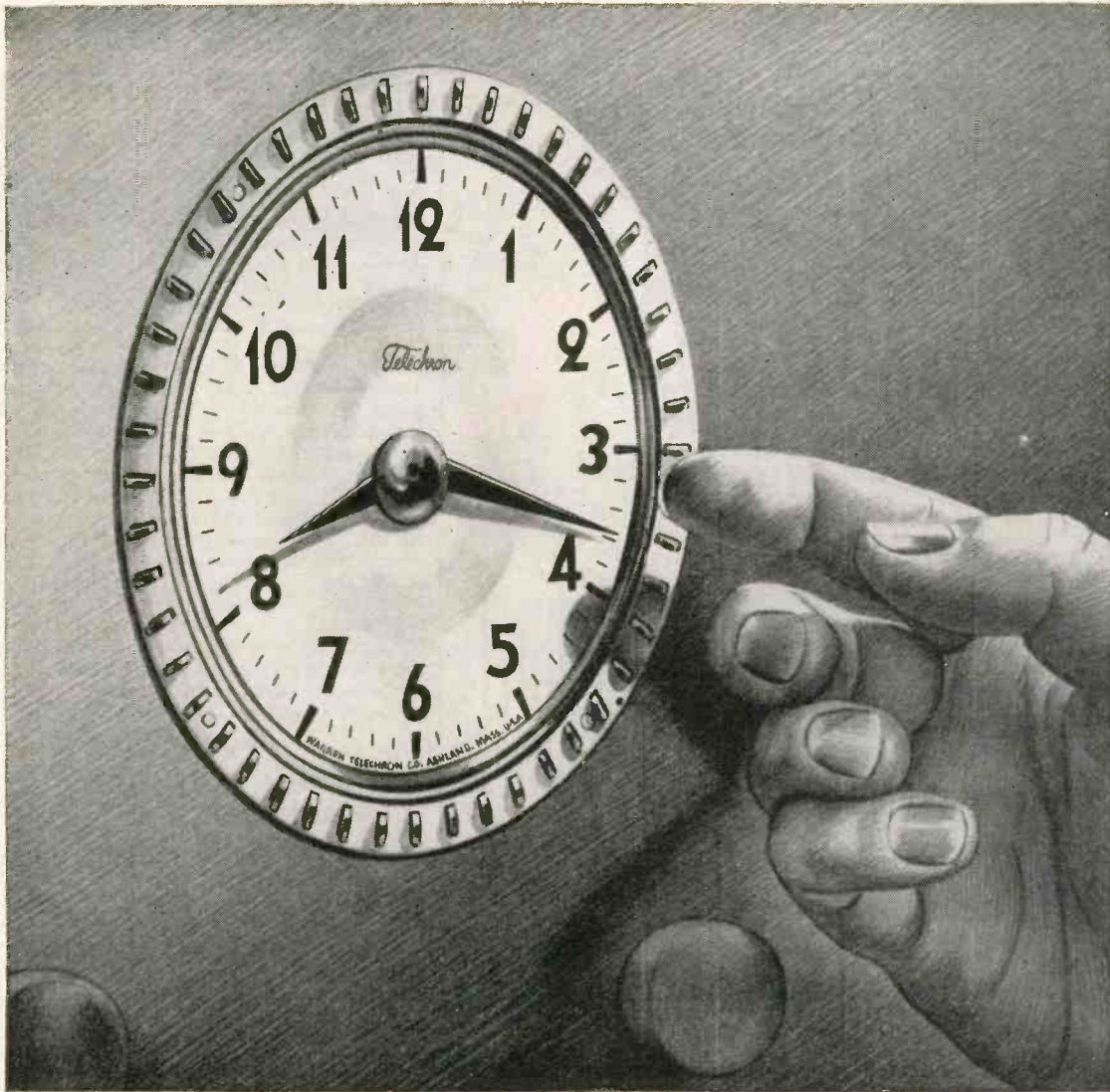

## A TELECHRON SELECTOR FOR POST-WAR RADIOS

**T**HIS carefully engineered timer gives radio receivers dramatic two-way sales appeal. It's a dependable electric clock that provides the accurate time listeners need. *But it's much more.* It turns on the set automatically at any preselected time in the morning to waken a member of the family—or the whole household—with music. It switches the set on for favorite programs during the day and evening and shuts it off at bedtime.

Set buyers will like the easy finger-tip control of this built-in Selector. There are no knobs to turn, no complicated settings, no difficult calculations. All that's needed to set the timer for any 15-minute period is to flip one of the 48 keys around the large, legible Telechron clock dial. Fifteen minutes after the set has been turned on, it will switch off unless the next key is also pulled. Keys are automatically reset to "off" position after timing periods are passed. Programs can be selected as far ahead as 10 hours.

The cost to radio set builders will be surprisingly low—less than \$4. That recommends the Selector for moderate-price receivers.

The Telechron Selector is only one of the full line of automatic timing and control devices we can supply for post-war appliances. All use famous Telechron movements and self-starting synchronous motors.

For full information about this and other Telechron timers, wire or write Automatic Control Division, Dept. K.

WARREN TELECHRON CO. • ASHLAND, MASSACHUSETTS

*Telechron*

REG. U. S. PAT. OFF.

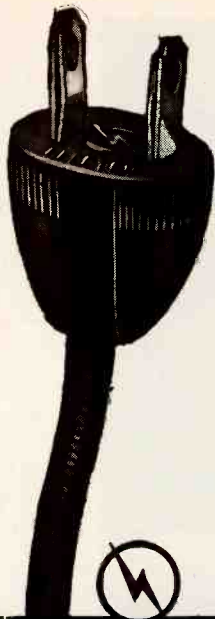

*Streamlined*

... in appearance  
... in assembly

**ELECTRIX  
PLUGS offer**

- ⚡ Superior features of mechanical design
- ⚡ Quick, easy assembly
- ⚡ Lowest cost per finished unit

**ELECTRIX**  
*Corporation*

140-158 MIDDLE STREET  
PAWTUCKET • RHODE ISLAND

UNITED STATES RUBBER COMPANY  
Exclusive Selling Agents

**ALDEN**

SHIELDED PLUGS & SOCKETS

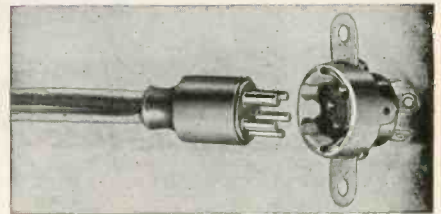

The new automobile set or any commercial requirement for shield grounding socket is going to demand this quality patented socket. Here's what it is and does. It's a metal seal socket that has a rounded edge entrance that grounds the plug upon insertion. The plug has long insulated protection for each lead and was designed to meet all the cable manufacturers' problems of efficient use, as to ease of cutting leads, preparing ends, soldering shield, and applying overbraids. The shield cover seals the plug dust, fungus and moisture tight. Quality—but again, by meeting our design standards, inexpensive with appreciable assembly saving whether supplied by us with the cable or cable is made by others.

Write for the

**ALDEN "BLUE-BOOK"**  
of Electrical Components

**ALDEN PRODUCTS COMPANY**  
BROCKTON (64E) MASS.

MODEL 200-B

**POWER SUPPLY**



continuously  
variable  
voltage  
plus  
regulation

**0-325 VOLTS D.C. at  
125 MA. Without Switching**

Due to its flexibility and ease of operation the Model 200-B Power Supply has a wide variety of applications in the laboratory and on the production line. Write for descriptive technical bulletin.

**VOLTAGES:** From 0-325 Volts D.C. at 125 Ma. continuously variable.

6.3 Volts A.C. at 6 Amps. center tapped  
**REGULATION:** Within 1% for voltages between 20-325 volts from no load to full load.

Within 2% at 10 volts from no load to full load.

**HUM VOLTAGE:** Less than 10 millivolts including noise.

**METERED OUTPUT:** Voltmeter and Milliammeter included to read output voltage and current.



**ELECTRONIC MEASUREMENTS COMPANY**  
RED BANK • NEW JERSEY

**ENGINEERS**

**MECHANICAL  
and  
ELECTRICAL**

*Experienced in*

**ELECTRONICS,**

Chassis Design

*and*

**DEVELOPMENT,**

**VARIABLE CONDENSERS**

*and*

**TRANSFORMER DESIGN**

**TOP FLIGHT SALARY**

*For Interview.*

*Apply or Write*

**HUDSON AMERICAN CORP.**

25 West 43rd St., New York 18, N. Y.



# Looking for Trouble-Free Control or Protection



## Investigate **KLIXON** Disc-Operated **CONTROLS**

Designers and manufacturers seeking accuracy and efficiency of operation in control or protection devices rely more and more on Klixon Disc-operated Controls.

The Spencer snap-acting thermostatic disc . . . the fool-proof actuating element of Klixon Controls . . . always snaps to a quick, clean break or solid make assuring accurate and dependable operation no matter how often it operates.

Small, compact, light in weight, Klixon controls meet design and exacting performance requirements in such applications as transformer overheat protection, electrical circuit overload protection, thermal time delays and temperature control for radio equipment. Their reliable operation is unaffected by motion, vibration, shock or altitude.

If you need control or protection, investigate Klixon snap-acting controls. They are available in many standard types to meet most requirements. Write for information, today.



Type RT Thermostat. Adjustable Temperature Control.

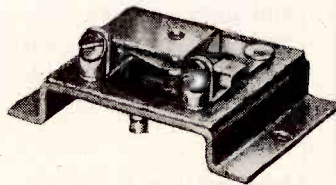

Type C-4351 Thermostat. Used for Tube Warming, Tube Cooling, High Limit Controls, etc.

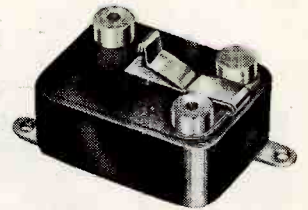

Type C-7220 Precision Snap Switch 12 amps, 30 Volts D. C., 125 Volts A. C.

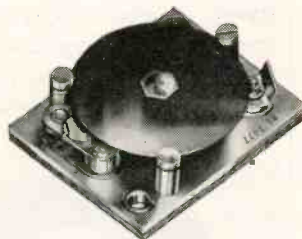

Type B-3120 Thermostat and Heater, Crystal Dew Point Control



Type C-2851 Thermostat. For such use as Roughing Controls on Outer Crystal Ovens.



Type PM (NAF-1131) Circuit Breaker.



Type ER Series. Ambient Compensated Time Delay Relays.



SPENCER THERMOSTAT CO., ATTLEBORO, MASSACHUSETTS

*Designed for*



*Application*

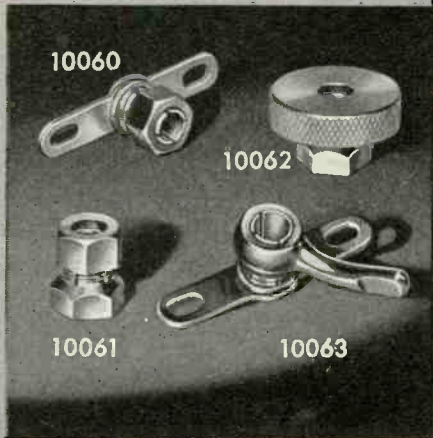

### SHAFT LOCKS

In addition to the original No. 10060 and No. 10061 "DESIGNED FOR APPLICATION" shaft locks, we can also furnish such variations as the No. 10062 and No. 10063 for easy thumb operation as illustrated above. All types are available in bright nickel finish to meet Signal Corps requirements or black oxide to meet Navy specifications.

**JAMES MILLEN  
MFG. CO., INC.**

MAIN OFFICE AND FACTORY  
**MALDEN  
MASSACHUSETTS**



at the end of the blade is from 3 to 6 oz. The manufacturer states that tests of these switches show a mechanical life expectancy of more than ten million operations. Acro Electric Co., 1316 Superior Ave., Cleveland 14, Ohio.

### Output Transformers

A NEW SERIES of hermetically-sealed aluminum-case output transformers has been designed by The Acme Electric & Mfg. Company of Cuba, N. Y. The manufacturer states the use of annealed steel cores and special vacuum-impregnated coils improves the operating efficiency and over-all performance. Terminals of Pyrex glass with Kovar electrodes and metal collars form a hermetic seal that complies with standards established for 5-cycle immersion tests.

### Indicating Instruments

HICKOK ELECTRICAL Instrument Co., 10527 Dupont Ave., Cleveland 8, Ohio, announces new hermetically-sealed electrical indicating instruments with internal pivot construction in 2½, 3½ and 4-inch round styles. Dimensions are in accordance with AWS specifications. The 4-inch types are for radio service equipment where several scale arcs

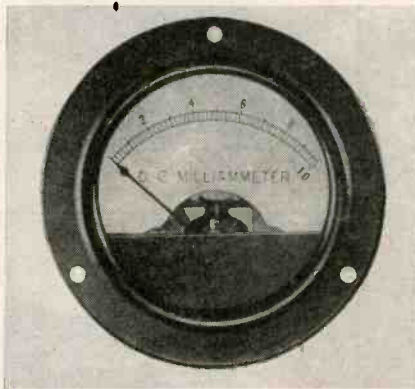

are required. All three styles include voltmeters, ammeters, milliammeters and microammeters, for both ac and dc. Units can also be sealed with dry air at sea level pressure or inert gas. Glass on the case will withstand 25 lb pressure per sq in. The instruments are vacuum and pressure tested under water. Terminals are special glass soldered-in type using a direct bond of glass to metal.

**SUN**  
**BEATING  
A PATH  
TO SUN  
RADIO**

**OVER 10,000  
ITEMS IN STOCK**  
**RADIO PARTS  
TUBES**

**Electronic Equipment**

TO MEET  
URGENT PRIORITY  
REQUIREMENTS

Everything in  
**TUBES · METERS · CONDENSERS  
RESISTORS · TRANSFORMERS  
TEST INSTRUMENTS · WIRE  
AMPLIFIERS · SOUND SYSTEMS, etc.**

★  
SUPPLIERS TO

Industrial Manufacturers · Research  
Laboratories · Schools · Colleges  
Government Agencies · Railroads  
Public Utilities · Broadcast Stations  
Hospitals · Shipyards · Police Depts.

**PURCHASING AGENTS!  
ENGINEERS!**

Send for this  
**FREE 800 PAGE CATALOG!**

Write today on your company letterhead for this massive 800 page Buying Guide containing everything in radio-electronics. Complete listings of all standard nationally known products in one handy, bound volume! Sent free on request by addressing Box "U.C."



**SUN RADIO  
& ELECTRONICS CO.**  
212 Fulton Street, New York 7, N. Y.

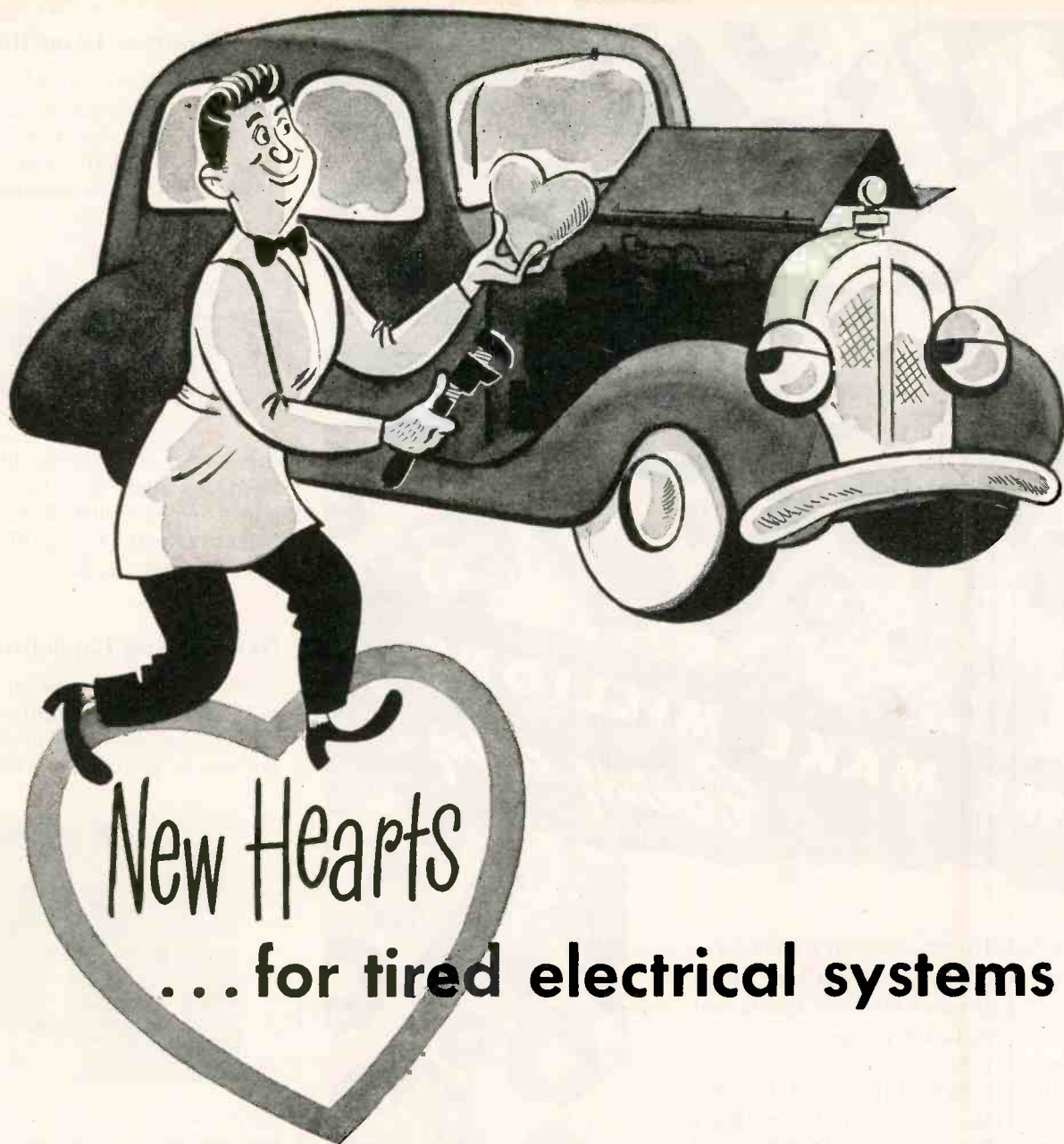

New Hearts

... for tired electrical systems



Keeping America's aging automobiles, trucks, tractors, and buses rolling is a vital wartime task.

Part of this task is performed by General Products Corporation, of Union Springs, N. Y.

They produce what are often called the heart of the electrical system—replacement ignition coils for many makes and models of vehicles.

Thus, when aging electrical systems develop heart trouble, General Products steps in with coils to give them new leases on life—to keep America rolling.

General Products coils are good coils—fully up to their tough jobs. That's why we at Wheeler Insulated Wire Company are proud to

supply the coil windings that go into them.

For the 35 years of its existence, Wheeler Insulated Wire Company has devoted its talents and experience to the manufacture of high-quality windings and other wire specialties.

Our entire capacity has been

bought by a comparatively few customers—mighty *good* customers!

After the war, we hope to have many additional customers—for our manufacturing facilities have been greatly expanded in the interest of the war effort.

When that time comes—*Remember Wheeler for Windings!*

**The Wheeler Insulated Wire Co., Inc.**

BRIDGEPORT 4, CONN.

*Manufacturers of Magnet Wire...Litz Wire...Coil Windings  
Transformers...Ballasts for Fluorescent Lighting*

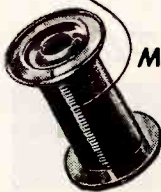



● This isn't an unusual statement at all—not when you're talking about punched parts made of Laminated INSUROK! For in the electrical insulation field Richardson precision plastics have long been favorite materials . . . used by the millions in all shapes, sizes and thicknesses.

This outstanding preference is easy to understand, for Laminated INSUROK is an easy-to-handle product whose physical characteristics remain commercially uniform. It can be drilled, punched, sawed, turned, planed or milled in your own shop—without special tools—or Richardson Plasticians will do it for you. Write today for the full story about INSUROK . . . laminated and molded.

# INSUROK *Precision Plastics*

*The* RICHARDSON COMPANY

MELROSE PARK ILL. NEW BRUNSWICK N. J. FOUNDED 1868 INDIANAPOLIS I. IND. LOCKLAND CINCINNATI 15 OHIO  
 DETROIT OFFICE 6-252 G. M. BUILDING DETROIT 2, MICHIGAN NEW YORK OFFICE 75 WEST STREET NEW YORK 6 N. Y.  
 CLEVELAND OFFICE 328-7 PLYMOUTH BLDG. CLEVELAND 15 OHIO

## Air-Trimmer Capacitor

UNITS ARE available either single or dual, in capacitance ranges from 5 to 140 mmf, with standard air gaps of 0.012, 0.015, 0.019, 0.030 or 0.045. Units have ceramic mount-

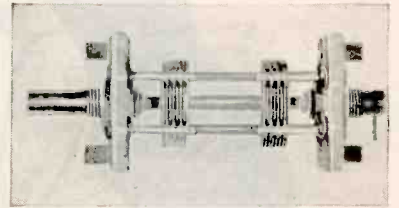

ing bases, with brass plates and mounting studs of either cadmium, silver or nickel plated, as required. Comar Electric Co., 2701 Belmont Ave., Chicago 18, Ill.

## Neutralizing Capacitor

TYPE TN capacitor is an addition to the type N line manufactured by E. F. Johnson Co., Waseca, Minn. for use in neutralizing circuits of

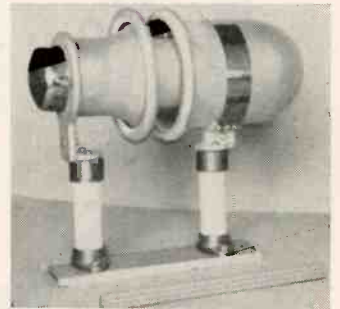

radio transmitters. Two sizes available are rated at 45,000 volts and 35,000 volts peak breakdown, respectively.

## Portable X-Ray Tube

A NEW X-RAY UNIT, using a shockproof tube (approximately 3 in. in diameter) examines internal structure of welds, rivets and other points of stress in confined spaces (such as airplane wings, fuel tanks, etc.) The tube is coupled to the generator by means of a shockproof cable and two small water hoses. The high-loading anode tubes are available with targets of copper, cobalt, iron, or molybdenum. Ratings range from 10 to 20 milliamp at potentials up to 50 kv, depending on the target material. North American Philips Co., 100 East 42nd St., New York 17, N. Y.

# PRECISION to 0.000070 Inch!

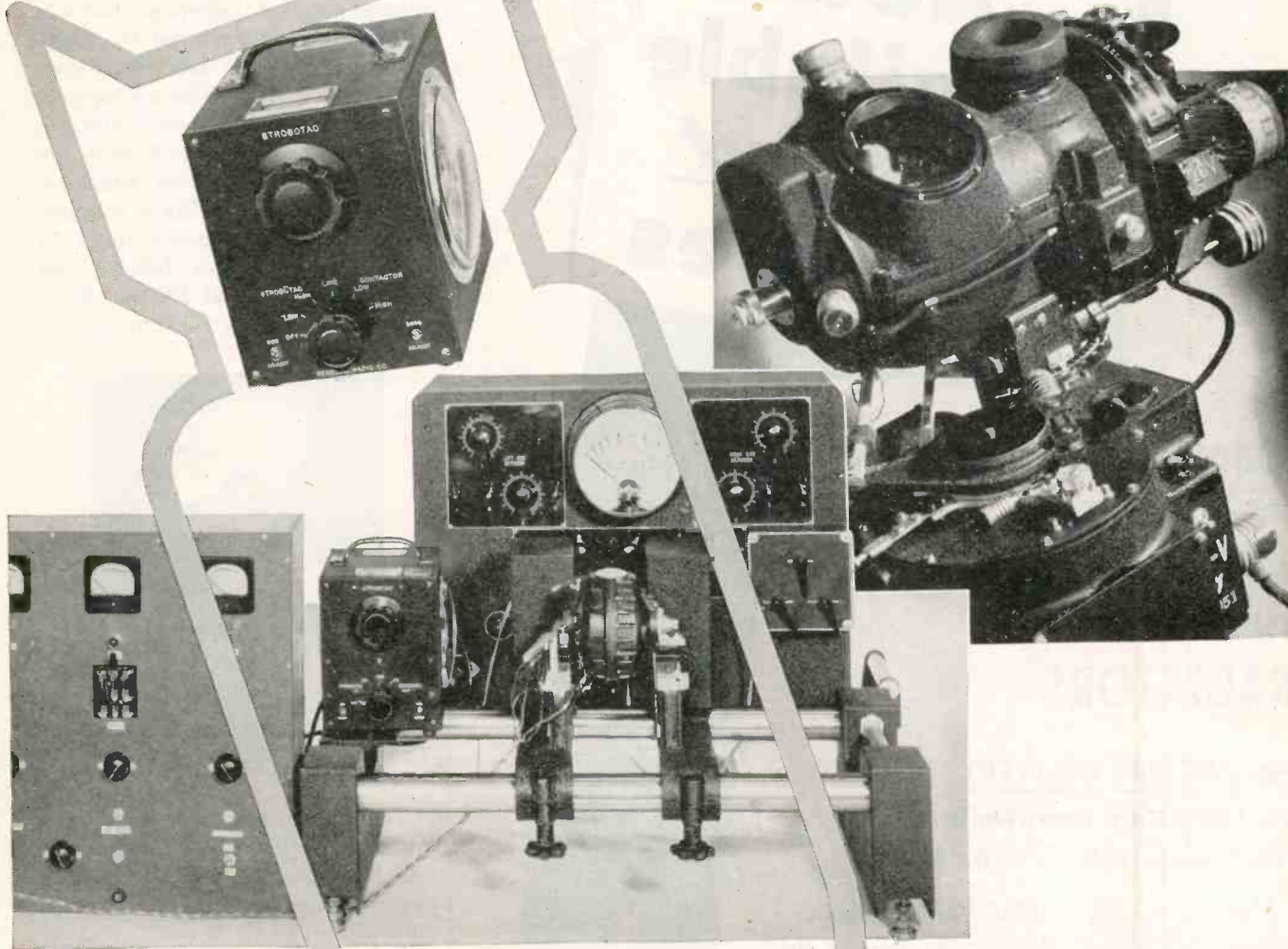

● One of the mechanical marvels of the war is the famed Norden Bombsight, until recently one of the most secret of military devices. Information on some of its general features has now been released by the Army.

This bombsight is probably the most precise instrument in the world, yet it is being built in mass production by the Victor Adding Machine Company and several other manufacturers.

The heart of the bombsight and its associated stabilizer are two gyros which have to be balanced to almost unheard-of accuracy. When inspected, the rotor must be centered to *70 millionths of an inch*.

To obtain this accuracy, each gyro is carefully adjusted on the balancing machine shown in the illustration. This portable unit is manufactured by the Gisholt Machine Company. General Radio's STROBOTAC is a part of this machine.

The control equipment at the left includes an electronic speed regulator which maintains the gyro at the speed selected by the STROBOTAC. The equipment behind the gyro measures the amount of weight to be removed from the gyro rotor to give balance, while the STROBOTAC again is used to point out the angular position at which unbalance should be removed.

Gradually as the requirements of military security are relaxed, we hope that we can tell you of many other war uses for General Radio equipment.

In the meantime, possibly your interest in the STROBOTAC is associated with the war effort. STROBOTACS are available for top-priority war work. If you'd like detailed information about the STROBOTAC, ask for Bulletin 962

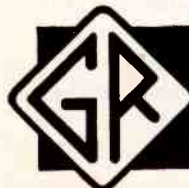

## GENERAL RADIO COMPANY

Cambridge 39,  
Massachusetts

90 West St., New York 6    920 S. Michigan Ave., Chicago 5    1000 N. Seward St., Los Angeles 38

**FLASH!**  
**Now**  
**Available**  
**Without**  
**Priorities**

**Place Your Order Now**  
**for**  
**LINGO VERTICAL**  
**TUBULAR STEEL**  
**RADIATORS**

→ **PROMPT DELIVERY**  
**on radiators manufactured**  
**from materials now on hand**

Now, you can buy a LINGO Vertical Radiator without the use of priorities. Because of the limited amount of materials and components available, orders will have to be filled on a first-come, first-served basis. Until such materials are made available in greater quantities, production will have to be concentrated on radiators not exceeding 250 feet in height. If you are not ready to have the radiator installed at this time, we can arrange to manufacture and deliver the radiator to you with your option to have it installed and erected by us when you are ready. We urge you to act immediately and thus be assured of having your radiator on hand when you want it.

*Please include in your inquiries the radiator height required and approximate site so that complete quotations can be immediately made covering the radiator itself and its subsequent erection when so desired.*

**JOHN E. LINGO & SON, INC.**  
**CAMDEN, NEW JERSEY** Est. 1897

**Submersion-Proof Micro-  
phone and Headset**

"WATER BUFFALO" is the name of a new submersion-proof lip microphone and headset combination developed by Bell Telephone Laboratories and manufactured by Western Electric Co., 195 Broadway, New York 7, N. Y. The microphone is equipped with an especially designed gland which will pass air but exclude water, and which is capable of withstanding a submersion cycle of 25 minutes under 10 inches of sea water followed by baking in an oven at 125 deg F repeated five consecutive times with-



out damage to the instrument. Not much larger than a half-dollar and less than one-half inch thick, the mike employs the differential principle of operation. When it is properly adjusted before the lips of the user, noise enters from the front and rear in phase and cancels out, thereby making the mike relatively unresponsive to unwanted sounds, yet sensitive to speech. Thus the mike and headset can deliver and receive articulate speech under the most adverse noise conditions. The headset, also submersion-proof, is of a flat-response type. It is fitted with soft neoprene ear-cushions to assure high transmission quality.

**Interpolating Counterdial**

THESE INTERPOLATING counterdials have the dial coupled directly to the driven apparatus to prevent their getting out of adjustment. The scale graduations run from zero to 100 for each revolution of the dial. Each graduation has two marked divisions, making a total of 200 readable parts on the dial, with the

# NEW SPECIAL PLASTIC SHAPES BY PLAX



Molding and continuous extruding by Plax, of special shapes in hitherto impossible sizes, open up a whole new realm of plastics applications.

While these applications have been restricted to wartime necessities, and for the most part may not be revealed, the mere indication of the shapes and sizes themselves will excite engineering minds to the visualization of their full possibilities.

The pieces shown in the photograph at the left range from a two-inch-thick slab of polystyrene to a six-inch-diameter cylinder and a four-and-one-half-inch diameter tubing with three-eighths-inch walls. These, the fluted tubing, the piece with varying cross-section, and many other special shapes can be produced in all colors, from crystal clear through jet black, in polystyrene and other thermoplastic materials.

Subsequent machining, with which Plax is thoroughly familiar, can produce unusual structural combinations with superior insulating and other desirable characteristics common to polystyrene and other plastics.

## LITERATURE IS AVAILABLE AS FOLLOWS:

Several bulletins on Plax polystyrene products and how to machine them.

A technical article on Plax blown products.

Bulletins on Plax cellulose acetate, cellulose acetate butyrate, methacrylate, and polyethylene products.

Styramic and ethyl cellulose are among the other materials offered by Plax in various forms. In cooperation with the Shaw Insulator Company, Irvington 11, N. J., Plax can give you help covering nearly all plastic materials and methods. For such help, or for any of the literature listed above . . . write Plax.



NOT SUBSTITUTES...IMPROVEMENTS

133 WALNUT STREET ★ HARTFORD 5, CONNECTICUT

# WAR RESTRICTED DEVELOPMENTS

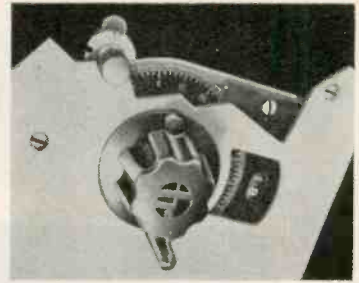

possibility of estimating accurately at least 200 more settings. An additional counting mechanism records each dial revolution, either forward or backward, thereby giving an accurate log of the setting in revolutions and fractions of a revolution. Standard stock units have two digit numbers (from zero to 99) but three digit numbers are available on special order. Technical Radio Co., 275 Ninth St., San Francisco, Calif.

## Now Available

in TELEVISO Series 200A  
Vacuum Tube Voltmeter

TELEVISO, pioneering in the production of measuring apparatus for the SONIC to UHF SPECTRUM, has specialized in building dependable Vacuum Tube Voltmeters.

A necessity wherever dependable voltage measurements within the range of 7 cps to 500 megacycles are required—the Televiso Series 200A VT Voltmeter is highly accurate and stable.

### FEATURES:

**SUPERSENSITIVE RANGE**—the lowest readable voltage is .05 volts on a maximum scale range of .5 volt.

**FIVE VOLTAGE RANGES**—5, 2, 15, 50, 150—spread full scale on a 4½" meter dial for easy reading. Accuracy of readings are 2% full scale; middle scale accuracy is 5% or better.

**PROBE CONSTRUCTION**—detachable probe to eliminate cable wear; easily dismantled for tube replacement or for soldering to tube terminals for measurements in the 250-500 MC region; flat ½" wide brass terminals connect to input to make easy soldering to test or work piece; for low frequency work up to 100 MC, removable banana plugs are spaced ¾" center to center for use with standard jacks.

**MECHANICAL CONSTRUCTION**—of aluminum throughout; panel and cabinet are ¼" thick (cabinet is dural.); sub-chassis is ⅛" and spaced off the panel by studs to simplify servicing; all components are fastened to sub-chassis.

**ELECTRICAL CONSTRUCTION AND CIRCUIT**—Series 200A utilizes the finest components throughout and carries a two year guarantee. The circuit is a stable plate circuit rectifier. No diode input tube is used. The plate circuit rectifier type makes available higher input impedance at all frequencies. No shortening of input probe is required for zero adjustments. All zero adjustments are made once and remain constant. A panel adjuster is available to make the unit usable without heating up time. All filament and plate voltages are transformer and tube regulated.

**BUILT-IN CALIBRATION VOLTAGE**—All units have a jack which produces a constant 6.3 volts for standardizing. This is the regulated filament voltage. The sensitivity can be adjusted without tools in the event tubes are replaced in the field. The Series 200A will operate satisfactorily from any source of voltage from 95 to 130 volts ac. Line voltage surges are not observable during use.

**SIZE**—14"H x 9½"W x 7½"D. Guaranteed 2 years. Price \$170.00 F.O.B. Chicago.

## Televiso Products Inc.

7466 IRVING PARK ROAD

CHICAGO 34, ILLINOIS

### Capacitors

THREE MANUFACTURERS announce new capacitors. The first of these is a non-resonant capacitor called "Hypass" which does not show

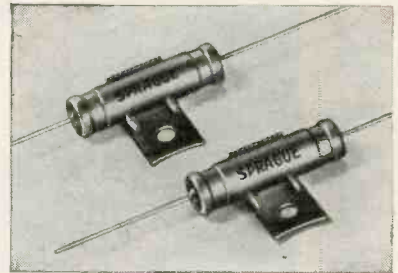

resonance at frequencies as high as 50 Mc, and in instances even up to 300 Mc. Sprague Electric Co., North Adams, Mass.

Technical Radio Co., 275 Ninth St., San Francisco, Calif. has added to their line capacitors with from 1 to 4 sections (20, 40, 120 and 230

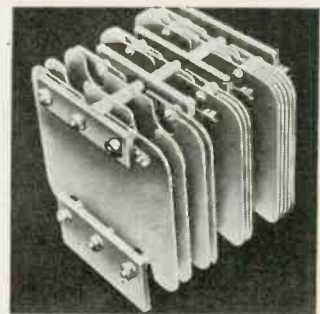

μf). Over-all dimensions of this capacitor are 5½ x 5¼ in. It is designed for the output sections of a pi-network.



# Continental-Diamond

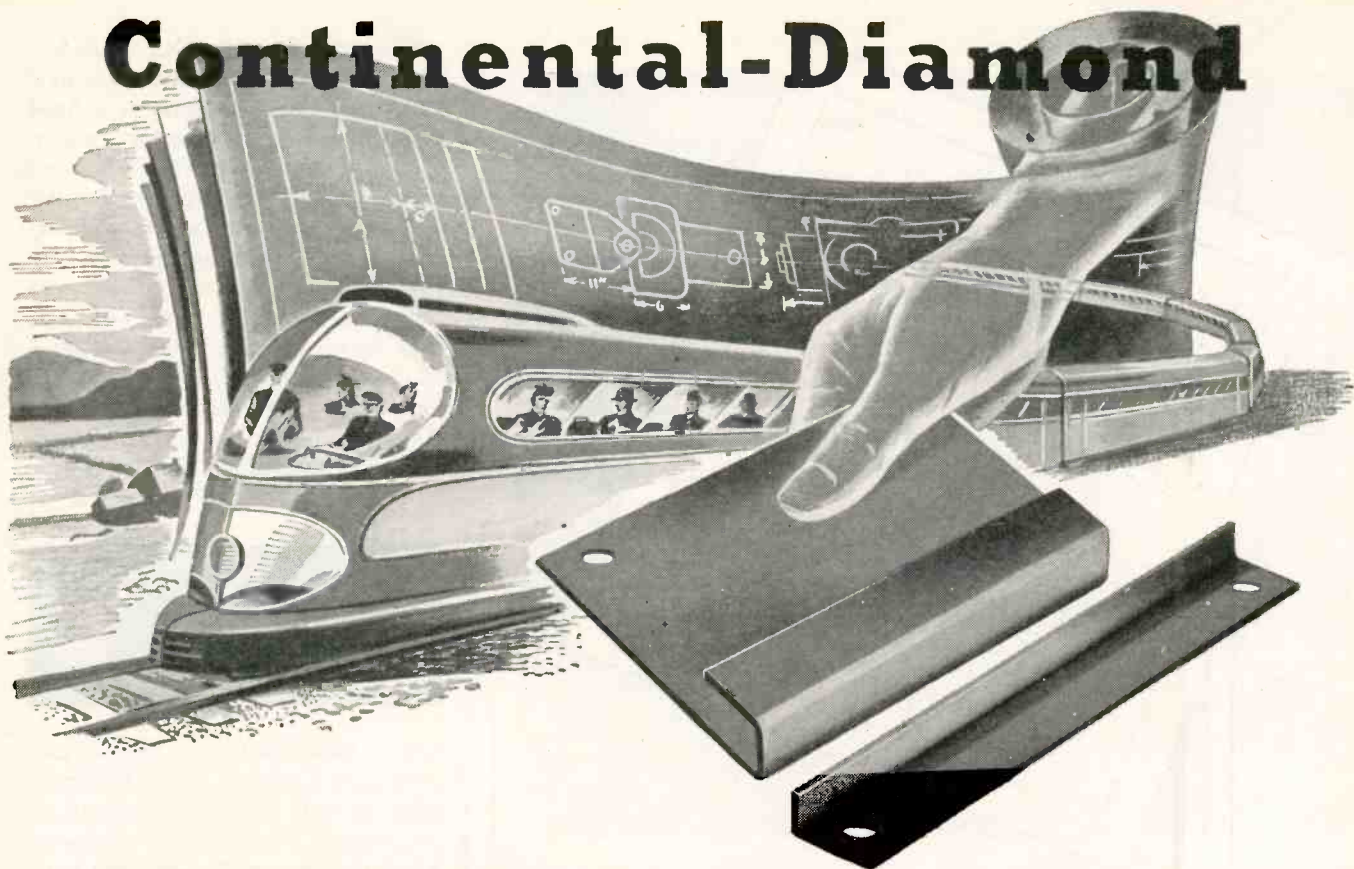

## fabricated NON-metallic parts that fit

*Pictured are two C-D DIAMOND Vulcanized FIBRE parts that were made from sheet stock... blanked out, smooth shaved, drilled and formed... to customers' blueprint.*

ON modern assembly lines, parts must fit! Economical production depends on rapid assembly of units. C-D fabrication methods are engineered to maintain dimensional accuracy just as all C-D products are engineered to meet specific electrical, mechanical and thermal problems.

Manufacturers who demand high standards in needed properties to insure unflinching product performance... and who also must have accurately fabricated parts to meet assembly line production problems... will want to investigate C-D NON-metallics.

KS-45

**C-D PRODUCTS**

**The Plastics**  
**DILECTO**—A Laminated Phenolic.  
**CELORON**—A Molded Phenolic.  
**DILECTENE**—A Pure Resin Plastic Especially Suited to U-H-F Insulation.  
**HAVEG**—Plastic Chemical Equipment, Pipe, Valves and Fittings.

**The NON-Metallics**  
**DIAMOND Vulcanized FIBRE**  
**VULCOID**—Resin Impregnated Vulcanized Fibre.

**MICABOND**—Built-Up Mica Electrical Insulation.

**Standard and Special Forms**  
 Available in Standard Sheets, Rods and Tubes; and Parts Fabricated, Formed or Molded to Specifications.

**Descriptive Literature**  
 Bulletin GF gives Comprehensive Data on all C-D Products. Individual Catalogs are also Available.

#### DISTRICT OFFICES

NEW YORK 17 • CLEVELAND 14 • CHICAGO 11  
 SPARTANBURG, S. C. • SALES OFFICES IN PRINCIPAL CITIES

WEST COAST REPRESENTATIVES  
 MARWOOD LTD., SAN FRANCISCO 3

IN CANADA:  
 DIAMOND STATE FIBRE CO. OF CANADA, LTD., TORONTO 8

**Continental - Diamond** FIBRE COMPANY

Established 1895.. Manufacturers of Laminated Plastics since 1911—NEWARK 16 • DELAWARE

*an Invitation  
to Peacetime  
Product Planners  
from the  
Valpey Crystal  
Corporation*



CBC-0

Where utmost in stability requires constant temperature control.



CM-1

A design for normal frequency control applications.



VP-3

Developed for use in limited space... in mobile equipment.

## Let Valpey engineers help you plan the "heartbeat" of your postwar product

Experienced in volume production of vital crystals for wartime communications needs, Valpey engineers and craftsmen are well equipped to solve any commercial crystal problem. Insure the success of your future products by planning to use Valpey Crystals in every "Vital Spot." Valpey's never vary.

Write today for complete "Crystionics" data

# VALPEY

## Crystal Corp.

CRAFTSMANSHIP IN CRYSTALS SINCE 1931  
HOLLISTON, MASSACHUSETTS

General Electric Co., Schenectady 5, N. Y. announces two new types. The first of these is a fixed paper-dielectric capacitor which comes in case style No. CP-70 and is for electronic equipment for d-c applications. There are 268 standard ratings, ranging from 0.1 to 15 microfarad, for circuit voltages from 600 to 12,500 volts. All ratings have a capacitance tolerance of plus or minus 10 percent. Complete data is contained in Bulletin No. GEA-4357. The second capacitor types available from G. E. are case styles CP-60, CP-62 and CP-64



fixed paper-dielectric capacitors with glass terminal seals. The glass seals provide resistance to humidity, fungus growths, and termites. All three case styles are available in both single-section and two-section construction. Capacitance values range from 0.05 to 0.50 microfarad, for voltages of 600, 1000 or 1500 volts.

### Current and Voltage Unit

MODEL No. 601 voltammeter consists of an ammeter and a voltmeter which comes in a single case measuring 12½ x 9½ x 10 inches. The ammeter measures from 0.2 to 500 amp in 8 current ranges. The voltmeter measures from 30 to 600 volts in 3 ranges. An inserted primary current transformer with



8-ft secondary leads facilitates measurement of current on 0-100, 0-250 and 0-500 amp scales without subjecting the meter to stray magnetic fields. Scales of the units can be easily and quickly read. Associated Research, Inc., 231 S. Green St., Chicago 7, Ill.



# What!... Voluntarily lower the price on a contract already awarded?

## Don't be silly!

To lower the price on a contract involving a *new* part is one thing. But when you "bid in" at a lower price than anyone else on a contract covering a device that's already history—and still reduce the figure after the deal is closed—it's something altogether different.

Specifically . . . a contract to turn out a special aluminum part for a major company making automatic pilots for Uncle Sam's fighter planes.

### We Cut Our Original Bid to Less Than Half . . And On Top of It Broke a Bottleneck

We bid low, at \$38.10 per unit. Up until then, each part required 54 inches of intricate welding—and there had been a shortage of welders capable of doing it. Rejects at testing had been 40%. It had been possible to make only 500 a week.

To boost the output, we looked for a better way of doing it. The answer turned out to be "impact

extrusion". Heretofore, manufacturers had used it only for small parts, limited to 2 inch diameter and 3 inch draw. In the process, we eliminated all but approximately 9 inches of welding—plus the need for critical aluminum tubing. Rejections dropped to about 2%. Production jumped to 500 a day, instead of 500 a week.

Our contract price \$38.10—but we billed \$18.85.

So, Uncle Sam gets the automatic pilots he needs . . . the prime contractor cuts his costs (on top of our original low bid)—and we're feeling very good about it.

Perhaps the fact that we have been in the sub-contracting business for over 50 years has something to do with our ability to improve part designs, cut production corners and lower costs.



Write on your business stationery for 48-page book, "Let Lewyt Do It"—the story of the Lewyt organization in pictures. Lewyt Corporation, 60 Broadway, Brooklyn, N. Y.



# Lewyt

A CONTRACT MANUFACTURER—EXPERTLY STAFFED TO PRODUCE COMPLETE ELECTRONIC AND MECHANICAL ASSEMBLIES, COMPONENT PARTS AND SUB-ASSEMBLIES, TO THE MOST EXACTING REQUIREMENTS

CONTINUE BUYING WAR BONDS

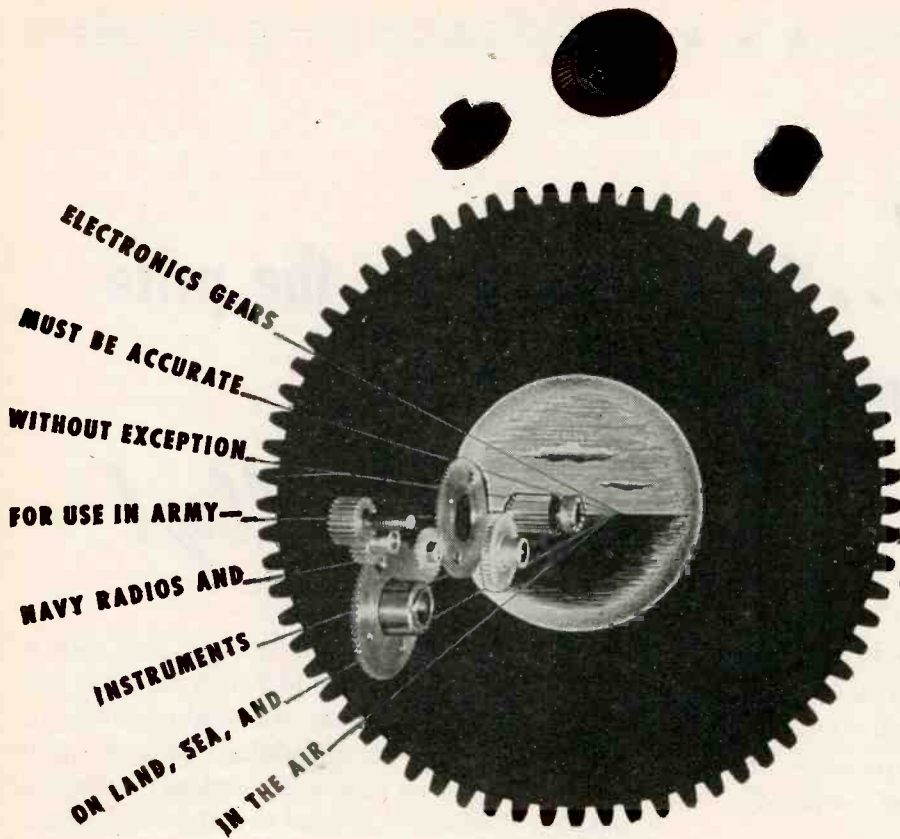

**ACCURACY CANNOT BE COM-  
 PROMISED WITH IN THESE WAR  
 DAYS OF LIGHTNING SPEEDS AND  
 WORLD WIDE COMMUNICATIONS,  
 ALL TUNED INTO OUR PRESENT  
 TEMPO BY PRECISION GEARS.**

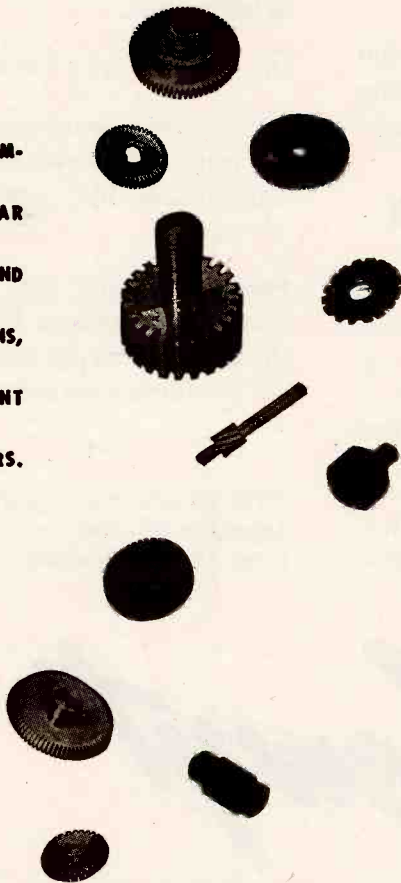

# Quaker City Gear Works

INCORPORATED  
 1910-32 North Front Street, Philadelphia, Pennsylvania

## Circuit Tester

THIS NEW multi-purpose circuit tester audibly tests continuity and insulation between wires, or from wires to ground. With a special indicator attachment it also determines visually the polarity of wires.



Operation is accomplished by a regulated hand-cranked generator which develops 500-volts d.c. Great American Industries, Inc., Connecticut Telephone & Electric Div., Meriden, Conn.

## Multimeter

THIS MULTIMETER, designated as Model PB-200 Speed-O-Meter, has a sensitivity of 2000 ohms per volt on both a.c. and d.c. It measures a-c or d-c voltages up to 1500 volts;



d-c current to 1.5 amp; capacitance to 30 mfd; decibels to plus 58; and resistance to 2 megohms. Superior Instruments Co., Dept. W, 227 Fulton St., New York 7, N. Y.

## Snap-Action Switch

A SMALL, push-button, snap-action switch called Snapit operates on a 0.0625-in. movement of the push button and carries a current rating of 10 amps at 115-volts a-c., and 2 amp at 115-volts d.c. The fixed contacts are of silver overlay on phosphor bronze. The contact gap is 0.040 in. on each contact. The

Kovar, the alloy that seals to glass, available as wire, rod, tubing, strip or foil

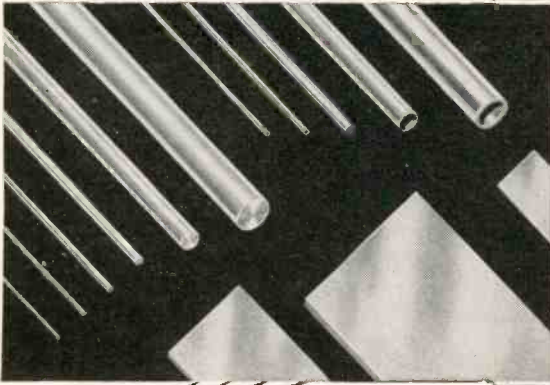

# Solve Your Sealing Problems...

## with KOVAR\*-Glass Hermetic Seals

**I**LLUSTRATED are some of the various forms in which Kovar—the alloy that seals to glass—are available from STUPAKOFF. Kovar—a cobalt, nickel, iron alloy, was developed specifically for sealing to hard glass and has been used commercially for that purpose since 1936.

Kovar forms a seal to hard glass through a heating process, in which the oxide of Kovar is dissolved into the glass. The result is a pressure and vacuum tight seal, effective under all atmospheric conditions.

To manufacturers equipped for glass working, STUPAKOFF supplies Kovar as wire, rod, tubing, strip or fabricated into cups, eyelets, leads or special shapes.

Completed seals are available as terminals with single or multiple, solid or hollow electrodes which can be quickly and easily soldered to a metal container. STUPAKOFF also manufactures meter windows, gauge glasses, graded seals and seals for special applications.

STUPAKOFF engineers will be glad to assist in developing Kovar-glass hermetic seals for your product. The booklet, "Kovar—The Ideal Alloy for Sealing to Glass," will be sent on request.

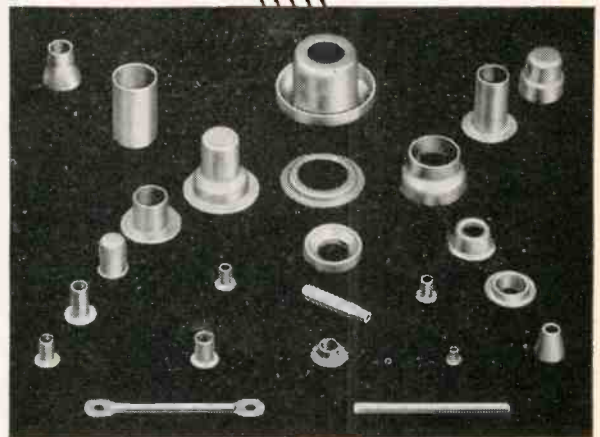

Kovar fabricated into cups, eyelets and special shapes

★ ★ Buy More Bonds ★ ★

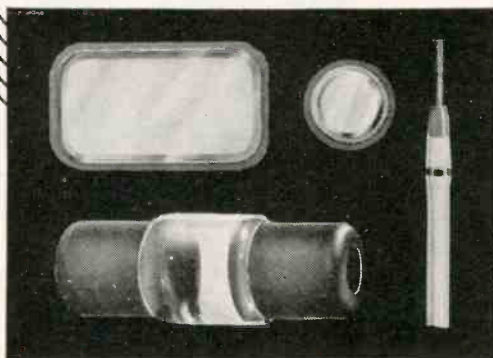

Kovar-Glass meter windows, gauge glasses, and special seals

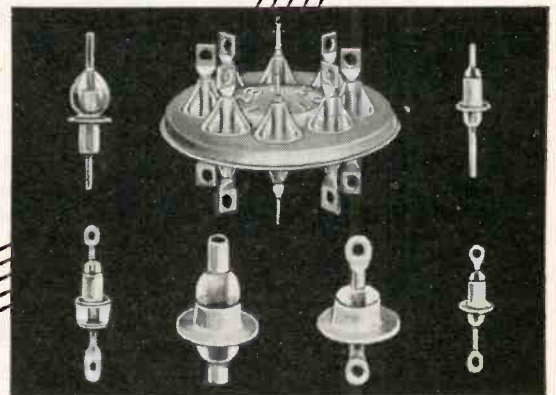

Complete Kovar-Glass terminals with single or multiple, solid or hollow electrodes

\* TRADE MARK 337962 REGISTERED IN U. S. PATENT



STUPAKOFF CERAMIC AND MANUFACTURING CO., LATROBE, PA.

*Products for the World of Electronics*





**The  
"Chin-Up"  
Girls are in the  
fight to the finish  
with . . .**

**KESTER  
CORED  
SOLDERS**

● Salute! To our American Women of Industry—for their amazing skill, their stout-hearted stick-to-it-iveness! They are in the fight to the finish—and Kester Cored Solders are smoothing the way in hundreds of war plants throughout the nation.

● These uniform, high quality, flux-cored solders are fast, easy to apply, and always permanent—a "must" for speedier production. And like the "Chin-up" girls, Kester Cored Solders are right on the job 'til Victory.

**KESTER SOLDER COMPANY**

4204 WRIGHTWOOD AVE., CHICAGO 39, ILLINOIS  
Eastern Plant: Newark, N. J. ● Canadian Plant: Brantford, Ont.



**KESTER**  
*Cored Solders*  
**STANDARD FOR INDUSTRY**

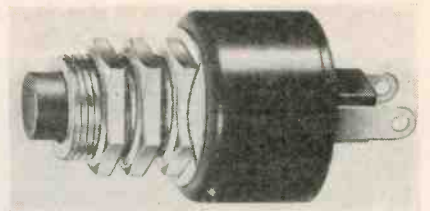

switch has a phenolic body which is round and which measures  $\frac{3}{4}$ -in. diameter x  $1\frac{1}{4}$ -in. high. Grayhill, 1 N. Pulaski Road, Chicago 24, Ill.

**Adapters for Solderless Wiring**

KNIFE-DISCONNECT component parts are manufactured by Aircraft-Marine Products (1591B North Fourth St., Harrisburg, Pa.) for rapid, inexpensive conversion of any existing electrical assembly for use with their knife-disconnect splicing terminals. The adapter is installed in the assembly in the same way as the solder tab it replaces. Adapters for vertical or horizontal conversion for wire sizes from 22 to 10 are available.

**Steel Nut Latch**

NEW, SPRING-STEEL speed-nut latch, No. 1663, is for instant attachment and removal of box covers, access doors, panels and inspection plates. Three styles of ball studs are available—drilled and tapped for 6-32 screws, threaded shank (632 thread) and plain shank for riveting. These, as well as grooved stud, are provided in various lengths to

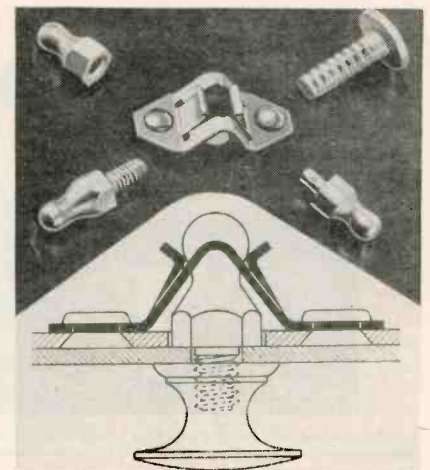

suit application requirements. Samples are available but it is necessary to specify pull-out tension required ( $3\frac{1}{2}$ , 8, 12, 18, or 30 lbs.); thickness

**THIS RADIO  
RECEIVER  
RACK...**

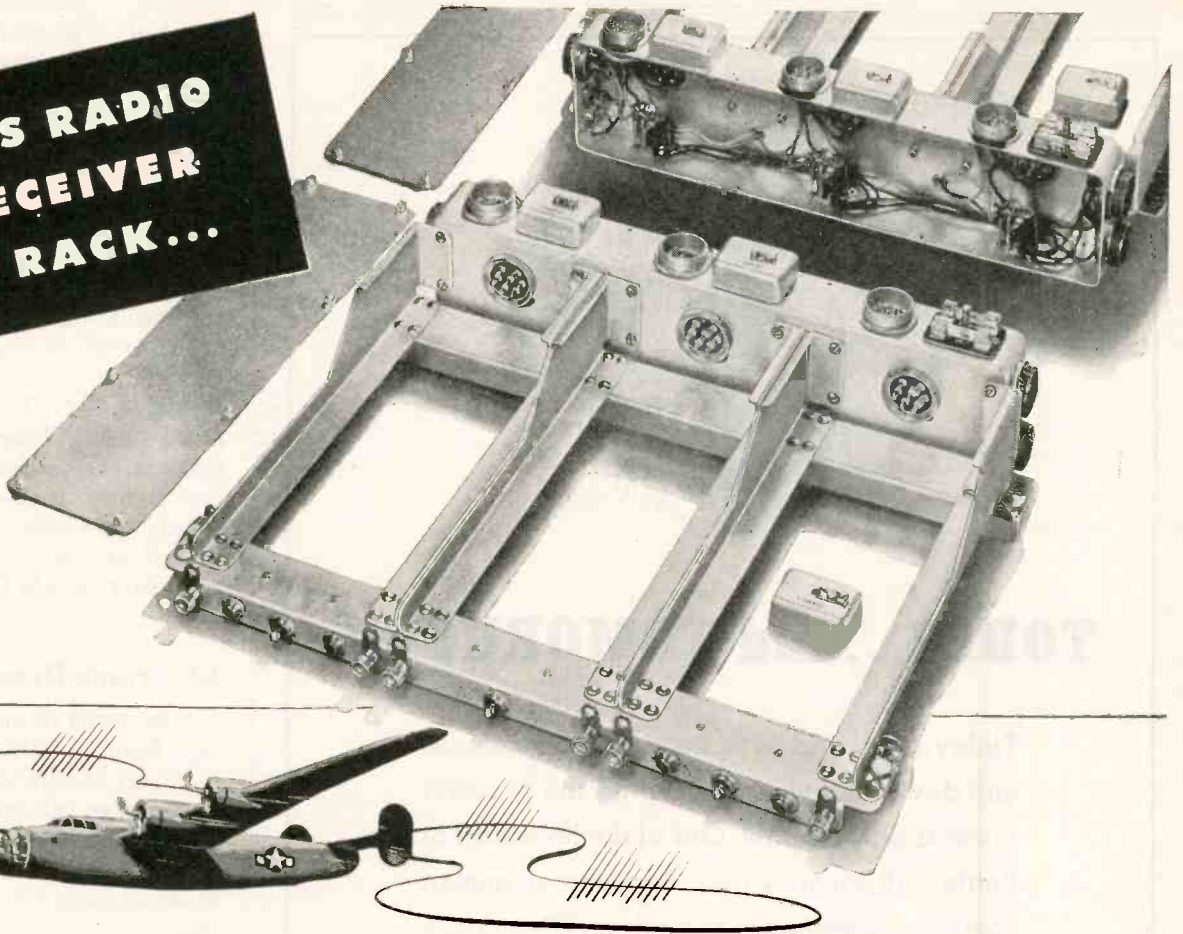

*contains more than 500 Electrōnents\*  
... all made and assembled by Scovill*

This three-position, high-frequency radio receiver rack for big bombers ... one of the most intricate manufacturing and assembling problems ever entrusted to Scovill ... shows how Scovill's versatile production facilities can meet requirements for electronic components or complete assemblies.

More than 500 individual parts are assembled in this rack. Materials used range from plastics to metal alloys in the form of sheet, rod, wire and tubing. Scovill makes all except glass and plastics components. Methods include

forging, stamping, drawing, heading, machining, and wire forming.

Even complicated wiring does not stump Scovill's production engineers. Every wire is cut to length, stripped and soldered into correct position. Relays are manufactured, tested and adjusted by Scovill technicians.

In other words, Scovill engineered the whole job for assembly-line production ... a service that can help you, too, save time, trouble and money on the production of small electronic components as well as large assem-

blies. For further details about the scope of Scovill's ingenuity and facilities, send for literature. Fill in coupon below and mail today. 

\*Electrōnents = Electronic Components



Please send me a free copy of "Masters of Metal" booklet describing your facilities. I am interested in the ELECTRONENT\* applications checked.

- |                                          |                                      |                                            |
|------------------------------------------|--------------------------------------|--------------------------------------------|
| <input type="checkbox"/> Batteries       | <input type="checkbox"/> Dials       | <input type="checkbox"/> Panels            |
| <input type="checkbox"/> Record Changers | <input type="checkbox"/> Escutcheons | <input type="checkbox"/> Sockets           |
| <input type="checkbox"/> Clips           | <input type="checkbox"/> Jacks       | <input type="checkbox"/> Stampings (misc.) |
| <input type="checkbox"/> Condensers      | <input type="checkbox"/> Lugs        | <input type="checkbox"/> Tubes             |

Other applications.....

**SCOVILL MANUFACTURING COMPANY**

Electronic Division  
22 Mill Street, Waterbury 91, Connecticut

Name .....

Company .....

Address .....

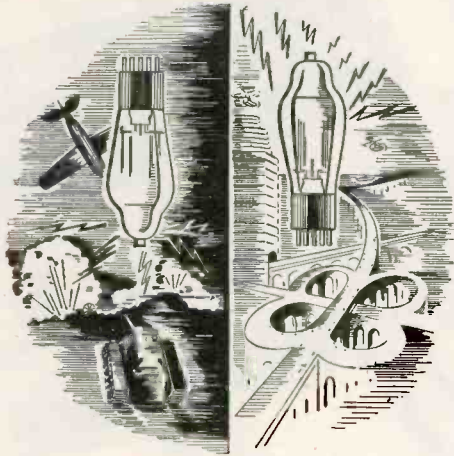

## TODAY...and TOMORROW!

Today, the world over, many of the machines and devices of war are shaping the peaceful pursuits of tomorrow. Out of the holocaust of battle will emerge new horizons of human comfort, convenience and safety. The science of electronics marches on!

Today, and every day, Temple engineers and technicians are toiling on new problems, developing new products, improving old ones—dedicated to the task of insuring final Victory—and inspired, as well, to anticipate the peacetime demands of tomorrow.



*Electronics Division*

**TEMPLE TONE**  
**RADIO MFG. CORP.**  
 New London, Conn.

of panel to which speed nut will be attached; type of stud; and length of plain or threaded shank, or length of grooved stud. Tinnerman Products, Inc., 2106 Fulton Road, Cleveland 13, Ohio.

### Insulating Grommets

FOUR NEW standard sizes of phenolic insulating grommets have been added to the line of Creative Plastics Corporation, 963 Kent Ave., Brooklyn 5, N. Y. These units are screw-type bushings which will not pop out of the chassis when wires are tightly packed through. For speedy assembly the collars are geared and matte finished. Hole sizes vary from  $\frac{3}{8}$  to  $\frac{1}{2}$ -in. clearance.

### Electronic Heater

A NEWCOMER TO the electronic-heating field is Climax Engineering Company of Clinton, Iowa, which is ready to go into production of Climax high-frequency heaters which are designed for quick, efficient, localized heat for surface hardening, annealing and brazing. The



equipment can also be used for such food applications as sterilization, pasteurization, deactivation of enzymes, cooking and heating, baking, destroying infestation, packaging and sealing. Climax expects to produce 12 different models of standard electronic heaters.

### Vacuum Indicator

FOR TUBE MANUFACTURERS there is a new type vacuum indicator (designated Tru-Vac) which operates from any 110-120-volt a-c outlet. It is scaled to read pressures of a vacuum system from 0.25 to 250 microns, and is accurate to  $\pm 2$  per-



# How G-E Mycalex keeps the Calrod dry

**AN IDEAL SEAL—IT'S MOISTURE PROOF—IT'S PERMANENT**

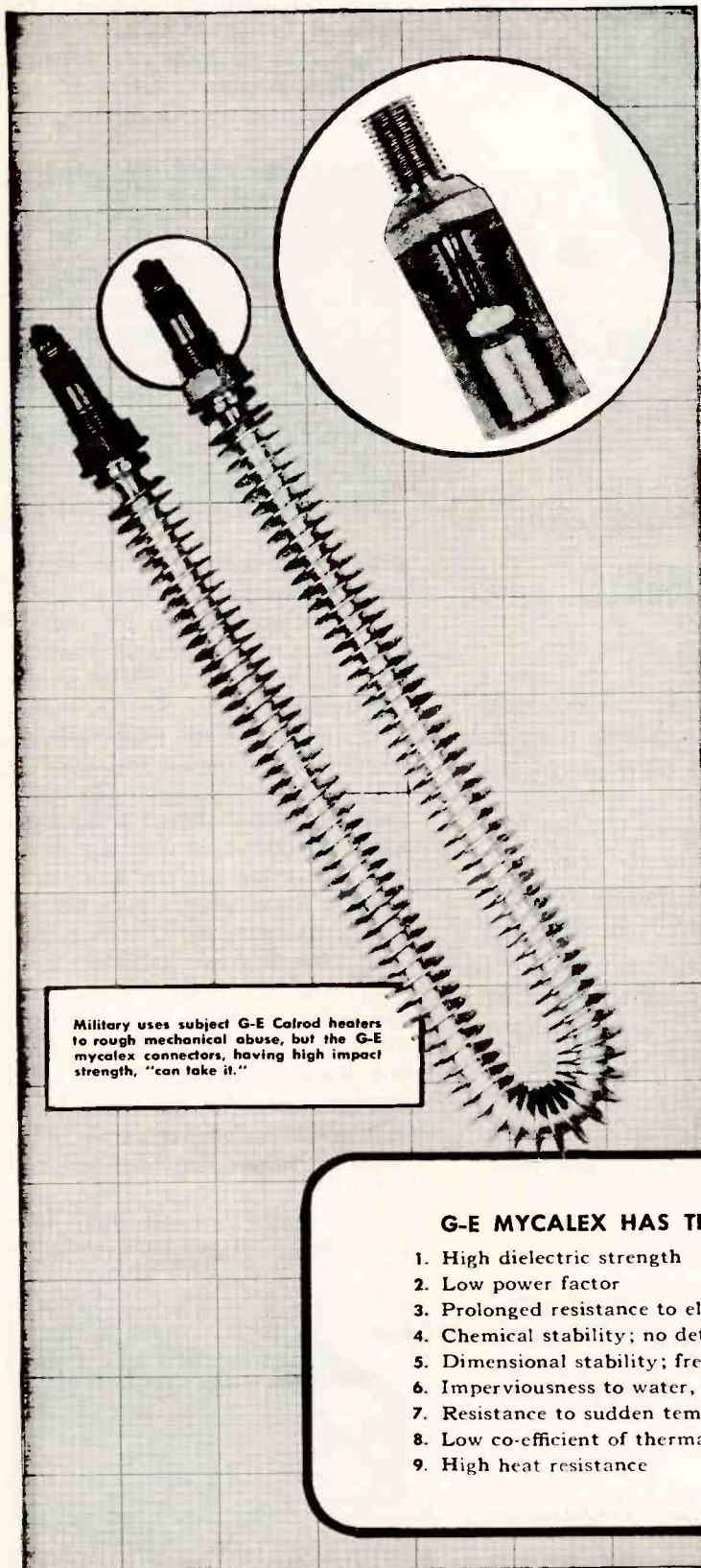

G-E MYCALEX utilizing metal inserts makes this sealed terminal connector for G-E Calrod heaters permanently moisture and oil proof.

## AND THE REASONS...

(1) Metal inserts can be combined with G-E mycalex during the molding process, and as a result, the metal and the G-E mycalex are fused into an unusually strong bond, locking out moisture, oil and gas.

(2) A permanent seal is assured because of G-E mycalex's unique properties. In this G-E Calrod application it is subjected to temperatures up to 375°C, constant exposure to water, oil and chemical fumes; yet G-E mycalex maintains its dimensional stability and the seal remains unbroken.

Only G-E mycalex was able to solve this tough insulation problem because it has a combination of features not found in any other insulation.

The General Electric Company solved this one and stands ready to put G-E mycalex to work in solving those "impossible" insulation problems of yours.

For further information, write section S-52, General Electric Company, 1 Plastics Avenue, Pittsfield, Mass.

Hear the General Electric radio programs: "The G-E All Girl Orchestra" Sunday 10 P.M. EWT, NBC. "The World Today" news every weekday 6:45 P.M. EWT, CBS. "G-E House Party" every weekday 4:00 P.M. EWT, CBS.

*Buy War Bonds*

**GENERAL  ELECTRIC**

PD-62

## G-E MYCALEX HAS THE FOLLOWING PROPERTIES:

1. High dielectric strength
2. Low power factor
3. Prolonged resistance to electric arcs
4. Chemical stability; no deterioration with age
5. Dimensional stability; freedom from warpage, shrinkage, etc.
6. Imperviousness to water, oil and gas
7. Resistance to sudden temperature change
8. Low co-efficient of thermal expansion
9. High heat resistance

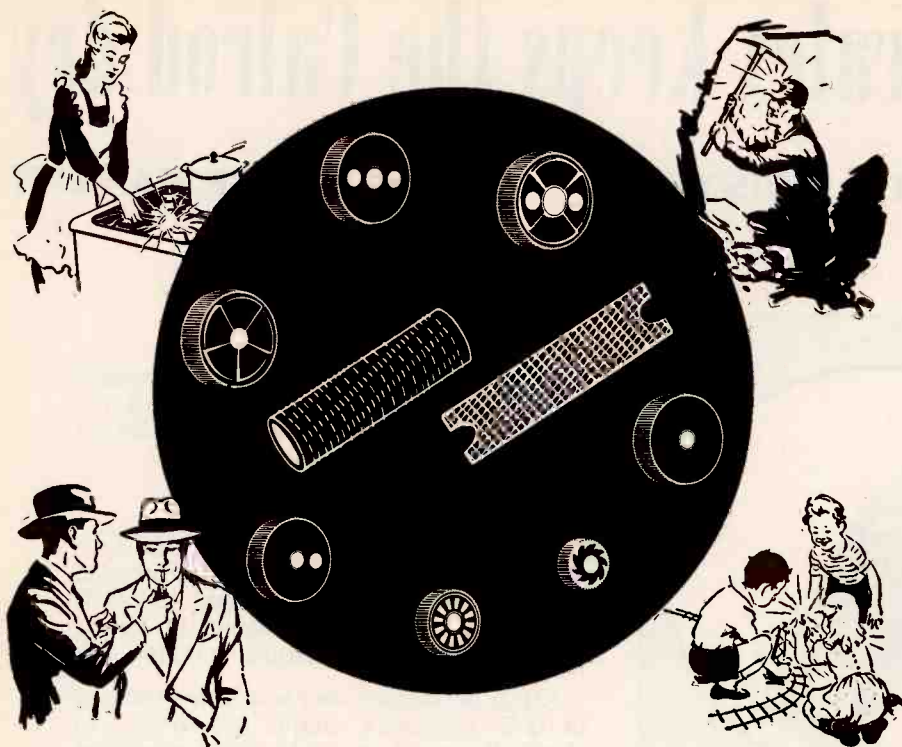

*There is no satisfactory substitute for*  
**BUCHMANN SPARK WHEELS**

**... IN THE WORLD'S FINEST SPARKING DEVICES**

For 33 years the universal standard of quality for all sparking devices, BUCHMANN SPARK WHEELS are available in stock sizes or made to your exact specifications for all manual and automatic sparking devices.

**... IN YOUR POST-WAR PRODUCTS**

Buchmann manufacturing facilities, greatly expanded to meet the needs of wartime, are today engaged wholly in essential production. But if you plan to manufacture cigarette lighters, gas lighters, mining lamps, sparking toys or other sparking devices, Buchmann Spark Wheel Corporation will gladly share the practical knowledge gained by 33 years of experience in this specialized field. As the world's largest manufacturer of spark wheels, Buchmann Spark Wheel Corporation gives your products the advantage of *recognized top quality in any price bracket*—a factor of first importance in the competitive years ahead.



**PRECISION SCREW MACHINE PRODUCTS**

Buchmann also manufactures special screw machine products and can assist you in the design and production of parts requiring machining to close tolerances. Inquiries are invited.

*There is no satisfactory substitute for precision*

**BUCHMANN SPARK WHEEL CORPORATION, 4-20 47th Avenue, Long Island City 1, N. Y.**

cent throughout the scale, with constant voltage. Meter may be read from a distance, if desired. Gage is unaffected by changes in barometric pressure. Continental Electric Co., Geneva, Ill.

**Resistors**

NEW TYPE RESISTORS have been announced by three manufacturers.

The first of these are Riteohm precision resistors, Series 82 and 83, announced by Ohmite Mfg. Co.,

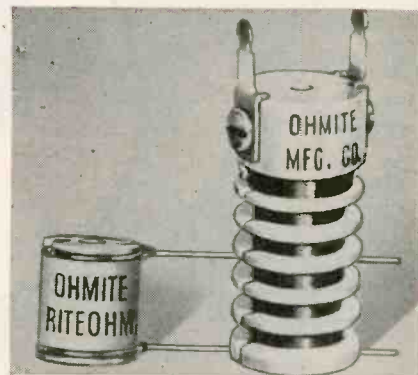

4835 Flournoy St., Chicago 44, Ill. Both types are pie wound to 1 percent accuracy and can be supplied with a fungus-resistant coating. Type 82 measures  $\frac{1}{8}$  inches in diameter, and  $1\frac{1}{2}$ , or  $1\frac{7}{8}$ , or  $1\frac{3}{4}$  inches long for the 2, 4 and 6-pie units respectively. Minimum resistance is 0.1 ohm for all units and the maximum is 400,000 ohms for the 2-pie unit, 750,000 ohms for the 4-pie, and 1 megohm for the 6-pie unit. Type 83 is available in three sizes— $\frac{1}{8}$  inch diameter x  $\frac{7}{16}$ ,  $\frac{3}{8}$  or 1 inch long. The first two units are 2-pie while the third is a 4-pie unit. Minimum resistance is 10 ohms for all units, and the maximum is 200,000 ohms for the small 2-pie unit, 400,000 ohms for the large 2-pie, and 800,000 for the 4-pie unit. Bulletin No. 125 describes units in detail.

Wire-wound "Sealed-Ohm" hermetically-sealed precision resistors

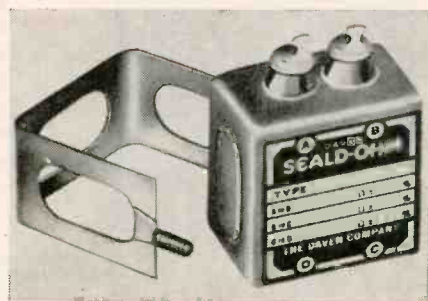



# A forward-looking American manufacturer offers Advanced Careers to a few qualified engineers and scientists



*Top salaries plus high royalty earnings*



*Excellent laboratory in fine building  
located in beautiful Southern New England community*

IN order to carry out a highly developed program of growth and expansion, we seek to augment the staff of our creative engineering laboratories with outstanding talent...and are prepared to do the things necessary to obtain it.

Applications are therefore invited from key engineers, research men and physicists experienced in industrial electronics, industrial control equipment, the design of automatic machines and allied fields. There are openings to satisfy the chief engineer, department head, project engineer, research engineer and the basic research scientist.

Salaries will at least equal those paid by other leading companies in the field, *but in addition, each candidate will receive a graduated percentage royalty on the sale of all products he develops. A portion of this royalty continues even if he later leaves the company.*

The conditions under which you will work are ideal. Our laboratory—housed in a splendid building—is well-equipped. You will be furnished with everything necessary to carry out the projects under your direction. The laboratory is located in one of the most charming residential communities of southern New England within commuting dis-

tance of New York—fine homes, excellent schools, modern shops and stores.

In order to receive fullest possible consideration, your application should present a detailed and comprehensive account of your experience and accomplishments, with particular emphasis on patents you may have obtained and contributions you have made to the origin or improvement of devices or techniques in your field.

The engagement of any candidate, of course, must be in accordance with War Manpower Commission and wage and salary regulations. If your present status precludes a change in position at this particular time, contractual arrangements can be made for you to join the staff at a later date.

We choose not to reveal the name of this corporation in this advertisement but every candidate interviewed will have the fullest opportunity of learning everything he wants to know about us. Further, your letter of application will be seen only by principals and will be held in the strictest confidence. All our staff knows of this advertisement.

Please address your letter to P-860, Electronics, 330 West 42nd St., New York 18, N. Y.



*Immediate  
Delivery*

## CO-AXIAL CONNECTORS

FOR  
50 AND 70 OHM LINES

# KINGS

*Electronics*

MANUFACTURERS OF  
**ELECTRONIC  
EQUIPMENT PARTS**

- **TERMINAL STRIP  
ASSEMBLIES**
- **ANTENNAE**
- **TRANSMISSION  
LINES**
- **RADAR  
ASSEMBLIES**
- **ALIGNMENT  
TOOLS**
- **SPECIAL  
EQUIPMENT**
- **WAVE GUIDES**

*For Complete Details  
Write for Catalog.*



**KINGS ELECTRONICS Co.**

372 CLASSON AVE.  
BROOKLYN 5, N. Y.

are announced by Daven Co., 191 Central Ave., Newark 4, N. J. These resistors may be employed as secondary standards, resistor elements in bridge networks, in voltage divider circuits and in attenuation networks. Resistor windings are non-inductively wound—in spool or mica-card types. Resistance range—any desired value, maximum 1,600,000 ohms. Four types of resistance wire of different temperature characteristics are available. Accuracy is rated plus or minus 0.1 percent to plus or minus 10.0 percent.

Five new types of hermetically-sealed resistors are available from Instrument Resistors Co., 25 Amity

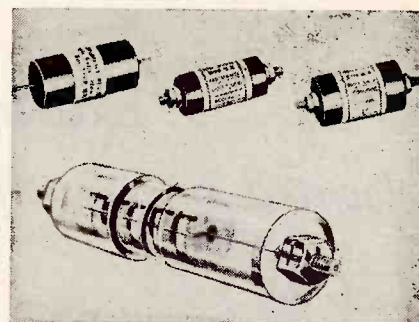

St., Little Falls, N. J. These types are: RX, SX, WX, CX and BX. CX and BX units have 2-inch No. 18 copper axial leads while the others are equipped with 8-32 threaded studs capable of mounting several lugs, wires or mounting brackets. All units are tropicalized. They provide a range to 1 megohm maximum, and 2 watts maximum. Tolerance is rated 1 percent.

### Dielectric Heater

A NEW DIELECTRIC heater, "Heat-master" for heating plastics, dehydration, sterilization and other purposes has been introduced by the Thermatron Division of the Radio Receptor Co., Inc., 251 West



# QUICK FACTS FOR ELECTRONIC ENGINEERS ABOUT S.S. WHITE FLEXIBLE SHAFTS

**S. S. WHITE FLEXIBLE SHAFTS** are made in two classes—power drive and remote control—each class specially engineered for its particular type of duty.

**POWER DRIVE SHAFTS** come in diameters from .043" to .750", with a selection of physical characteristics in the various sizes.

**REMOTE CONTROL SHAFTS** in diameters from .117" to .437", also with a selection of characteristics in the different diameters.

**APPLICATIONS** of both classes in radio and other electronic equipment, total millions of feet annually.

**A FLEXIBLE CASING** is needed with practically every flexible shaft to serve as a runway to prevent "helixing", to protect the shaft and to retain lubricant. S.S.White's comprehensive selection of metallic, fabric-covered and rubber-covered casings, includes a suitable companion casing for every S.S.White shaft and service condition.

**S. S. WHITE END FITTINGS** for connecting shafts and casings are available in many designs originally developed for numerous actual applications. Hence, they include designs suited to most applications. There is economy in using these standard fittings when practicable.

## S. S. WHITE FLEXIBLE SHAFT AND CASING COMBINATIONS

Combinations of selected shafts, casings and end fittings can be supplied in any required length. Although some S.S.White Combinations, such as the tachometer drive, are standard, no combinations are stocked. They are all made to user's specifications. The majority of power drive combinations have been under 10 feet, but many 30-foot combinations, and some up to 50 feet, have operated successfully. Remote control combinations have run up to 80 feet.

## COMPLETE FACTS IN THIS 256-PAGE HANDBOOK

This standard handbook-size volume completely covers the subject of flexible shafts. It gives all essential technical data and explains how to select and apply shafts for specific requirements. A copy will be sent free, if you will write for it direct to us on your business letterhead and mention your position.



**S.S. WHITE INDUSTRIAL DIVISION**  
THE S. S. WHITE DENTAL MFG. CO. DEPT. E 10 EAST 40th ST., NEW YORK 16, N. Y.



FLEXIBLE SHAFTS      AIRCRAFT ACCESSORIES  
MOLDED PLASTICS  
MOLDED RESISTORS      FLEXIBLE SHAFT TOOLS

*One of America's AAAA Industrial Enterprises*

# A COMPLETE RADIO STATION all in one package!

Typical of ERCO'S engineering ability to build completely coordinated Radio Stations is the unit illustrated. Built for Sperry Gyroscope Company, Inc., this equipment unifies a 200-watt radio telephone and telegraph transmitter, three 32-D fixed frequency receivers, one variable frequency receiver, speaker panels and operating position.

Variations of the illustrated console, in any combination of equipment, are available for your own needs. Panel assemblies can be interchanged to any arrangement. Each is replaceable to eliminate obsolescence.

ERCO'S specialized knowledge and technique is reflected in custom-built equipment for such varied users as Pan American Airways, American Airlines, General Motors, Eastman-Kodak, Grumman, Sperry, National Carbon, Westinghouse, and the Hudson's Bay Company.

Whatever your requirements . . . police, airline or industrial; mobile, ground to air, base to branch, office to field . . . ERCO provides complete service in the design, manufacture and installation of equipment that is engineered specifically to meet YOUR needs. We invite your inquiry.

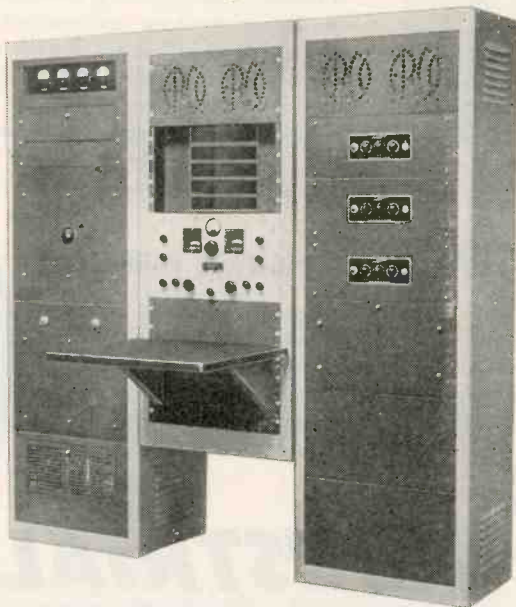

19th St., New York 11, N. Y. The unit is completely self-contained, and is designed particularly for heavy-duty preheating of plastic molded parts. It is capable of heating a 3.3-lb preform in 1 minute or a 5-lb preform in 90 seconds. Output is rated 5 kw plus; input—approximately 8 kva; line voltage—220 volt, 60 cycle, 3 phase; frequency—30, 15 or 5 Mc; size—24 x 28 x 59 inches high; weight—approximately 1000 lb.

Other Thermatron units are available over a range suitable for almost any purpose. These units are rated at output and include Types K-500, K-1, K-3, K-8, K-15 and K-30.

## Durez Molding Compound

THE HARRY DAVIS Molding Company has an extensive line of control knobs molded from Durez plastics and suitable for all standard

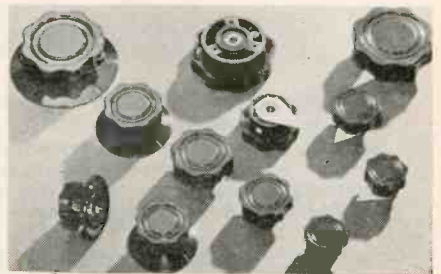

requirements. Available in a wide range of styles, the knobs are fluted to permit positive grip for critical calibrations. The Durez plastic used is unaffected by perspiration, greases or oils, is self-insulating, and will not chip or break easily. Illustrated below are National Fabricated Products octal radio sock-

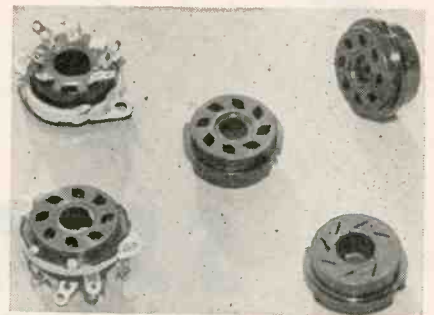

ets, designed to use a minimum of chassis space. Self-aligning contacts float in the Durez plastic insulation and provide the necessary safeguards against fracture of the glass seal of the tube resulting

## ERCO RADIO LABORATORIES INC

HEMPSTEAD, NEW YORK

Manufacturers of CUSTOM BUILT RADIO APPARATUS

# AVAILABLE

PROMPT DELIVERIES

ON 3 B 24 TUBES

IN QUANTITY



Lewis 3B24 tubes have been proved by grueling tests on the battlefields of the world . . . for ruggedness, reliability and soundness of design. Immediate deliveries can now be made . . . in quantity.

**Furnished to JAN-1A specifications**

**TANTALUM PLATE · THORIATED  
TUNGSTEN FILAMENT · CRYSTAL  
CLEAR HARD GLASS (NONEX)  
BULB · LOW-LOSS PHENOLIC BASE**

*Peak Voltage 20,000*

*Peak Current 300 Ma.*

*Filament Voltage 5.0*

*Filament Current 3.0*

Licensed under RCA patents

*Other type tubes  
in production at  
Lewis Electronics:*

3C24 - 3C28 - 4E27 - 878

217A - 217C - 833A

## **Lewis Electronics**

are pioneers in the field of Electronics. All types of water and air-cooled transmitting tubes and rectifiers . . . backed by 20 years engineering experience. In the electronics field, it pays to think of LEWIS!

For immediate action, write, wire or telephone

**Lewis** ★

**ELECTRONICS**  
LOS GATOS · CALIFORNIA

"KURMAN SENSITIVE" OF 1930 - STILL THE BEST

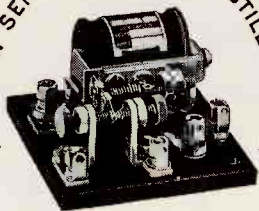

*New Features*  
added to  
**KURMAN RELAYS**

*The Well-Known*  
**KURMAN SENSITIVE RELAY**

the first to demonstrate the superior magnetic properties of hydrogen-annealed nickel alloy 15 years ago—again introduces an outstanding new feature:—

**CHATTERLESS OPERATION**

— obtained through cushioning of contacts in an energy absorbing material. This feature enables keying up to 150 words p. m. Mica insulation of the armature makes the relay suitable for keying 50 m. c. RF signals.

**25 YEARS' EXPERIENCE,**

a thoroughly competent staff of Development and Design Engineers, and complete manufacturing facilities are at your service when you submit your Relay problems to us.

Write for details on:

- KURMAN LINE OF RELAYS
- KURMAN VIBRATOR CONVERTERS
- KURMAN MICROPHONE HUMMERS

**KURMAN ELECTRIC CO.**

35-18 37th STREET • LONG ISLAND CITY 1, N. Y.



For trouble-free operation in any climate and at any desired altitude,

**HERMETICALLY SEALED**

relays are available, either of plug-in type or equipped with solder lugs. Some of these relays take as little space as 2" x 1 1/4" dia., and have up to 10 amps current capacity due to the special atmosphere introduced into the container under pressure.



**FOR ANY  
ROTATING  
SHAFT**

Specially engineered for many electronic applications where dependability is vital, "Sealol" seals fluids, including gases, with minimum friction and power loss. Atmospheric pressure or moisture may be sealed *out*, or lubricant retained *within*. "Sealol" is available in many constructions—non-corrosive for use at sea; carbon-faced for self-lubrication; with or without retainer,—engineered for efficient sealing at any desired pressure.

Send  
for  
Bulletin

**SEALOL CORPORATION**

45 Willard Ave., Providence 5, R. I.

Baltimore • Chicago • Cleveland  
Detroit • Los Angeles • New York

**CHASSIS • CABINETS • PANELS • RACKS**



*Skill in* **METAL**

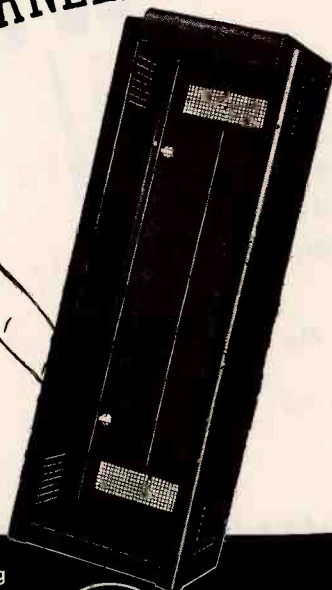

PAR-METAL . . . a specialized manufacturing plant employing modern high-speed methods. Nevertheless, Par-Metal products have a definite quality of Craftsmanship—a "handmade" quality born of genuine skill and long experience. Write for Catalogue.



Serving the  
Electronics  
Field  
Exclusively

**PAR-METAL PRODUCTS CORPORATION**

32-62—49th STREET . . . LONG ISLAND CITY, N. Y.

Export Dept.

100 Varick St., N. Y. C.



from possible misalignment of tube pins. Durez Plastics & Chemicals, Inc., North Tonawanda, N. Y.

### Synthetic Insulation

NEW SYNTHETIC insulation called "Flexitube" meets exacting specifications and is suited for use on all wire insulation purposes in radio and communications assemblies. The material has high flexibility, is resistant to abrasion, and has high dielectric strength. At room temperature, Flexitube averages 15,000 volts, with a guaranteed minimum of 12,000 volts for all sizes. Forty-eight hours immersion in tap water results in a reduction of less than 10 percent of its original dielectric strength. The material will not become hard or brittle under temperatures ranging from minus 35 to plus 75 deg C. Walter L. Schott Co., 9306 Santa Monica Blvd., Beverly Hills, Calif.

### Speaker

TYPE NF-300 reproducer, originally developed as a talk-back unit in ship intercommunicating systems, is a special-purpose speaker for use in severe weather or difficult oper-



ating conditions. Voice coil impedance is 12 ohms, nominal value. Maximum handling capacity for speech is 10 watts. Jensen Radio Mfg. Co., 6601 S. Laramie Ave., Chicago 39, Ill.

### Relays

BOTH POTTER & Brumfield Mfg. Co. (Princeton, Ind.) and R-B-M Mfg. Co., (Division of Essex Wire Corp., Logansport, Ind.) announce new relays. The R-B-M is Type 20000 multi-contact relay for minimum operating currents. Contact spring

**When all operations  
are "In the Family"**

- Engineering-Design & Development
- Laboratory & Model Shop
- Tool & Die Making
- Coil Winding
- Impregnating
- Blanking & Annealing of Core Steel
- Fabrication of all Mounting Parts
- Complete Assembly
- Compound Filling
- Inspection & Testing

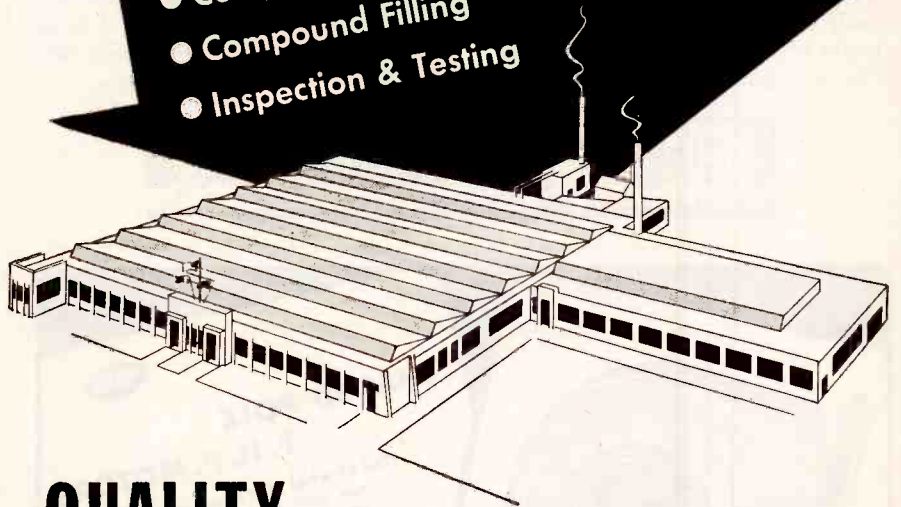

**QUALITY CONTROL** *is at its best*



Because they are in immediate touch with every step in manufacture, Chicago Transformer's engineering and inspecting departments make Quality Control truly effective. Smooth flowing production is facilitated, and dependability and accuracy become performance characteristics of the finished product.

**CHICAGO TRANSFORMER**

DIVISION OF ESSEX WIRE CORPORATION

3501 WEST ADDISON STREET

CHICAGO, 18



**RIVETS ARE A PRACTICAL and ECONOMICAL FORM OF**

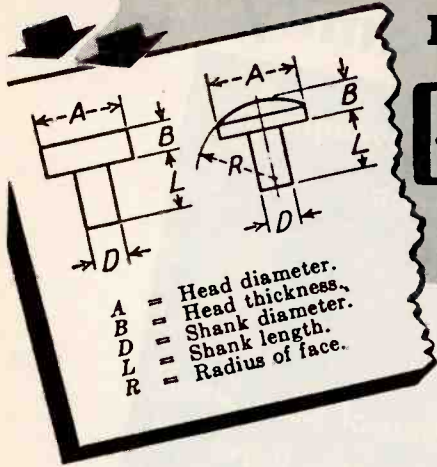

**Gibsiloy**  
ELECTRICAL CONTACTS

For small and medium sized apparatus requiring low or moderate current, one of the simplest, most convenient and economical forms of contacts to use is the solid contact rivet. It is also generally the least expensive form of contact to assemble. Gibson contact materials most generally used in this form

are Fine Silver, Coin Silver and Gibsiloy A, which is a product of powder metallurgy consisting of silver and nickel, possessing a combination of desirable electrical and mechanical properties not obtainable with alloys.

Because contact rivets are used in such large numbers in a wide range of sizes, manufacturers and users have developed a standard for sizes and shapes and recommend its adoption. A list of these standards will be sent on request and without obligation. Write today.



**NEW IMPROVED**

**"T"-PAD**

**ATTENUATORS BY TECH LAB**

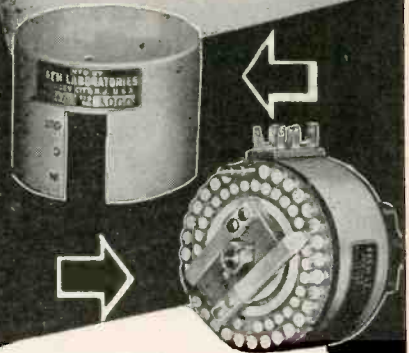

- Stainless Silver Alloy contacts and wiper arms.
- Rotor hub pinned to shaft prevents unauthorized tampering and keeps wiper arms in perfect adjustment.
- Can be furnished in any practical impedance and db. loss per step upon request.
- Write for our Bulletin No. 431.

**TECH LAB MICROHMMETER**



Direct and instantaneous resistance readings down to 5 microhms and up to 1,000,000 megohms. Write for Bulletin No. 432.



7 LINCOLN STREET  
JERSEY CITY 7, N. J.

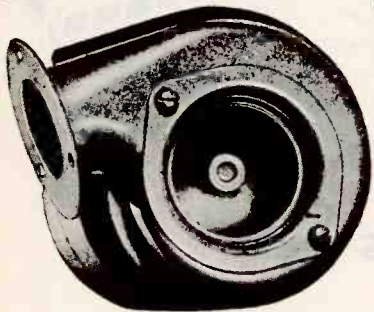

**BLOWERS for Electronic Equipment**

Easy-to-install . . . compact . . . quiet-running . . . economical . . . these are the features which make Pilot Blowers ideal for the important job of air circulation and ventilation in Radio Equipment. Available in standard models to move from 15 to 100 C.F.M. Write for Bulletin 507.

**SHADED POLE F. H. P. MOTORS**

Tell us what your requirements are and we will send you "fact sheets" giving complete specifications on these dependable, efficient, low-cost Motors. For continuous or intermittent duty with H.P. ratings ranging from 1/15 to 1/500 H.P. Plain round or with base or resilient mounting . . . open or

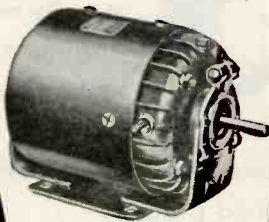

F. A. SMITH MFG. CO., INC.  
801 DAVIS ST., ROCHESTER 2, N. Y.

SHADED POLE MOTORS **Pilot** CENTRIFUGAL BLOWERS

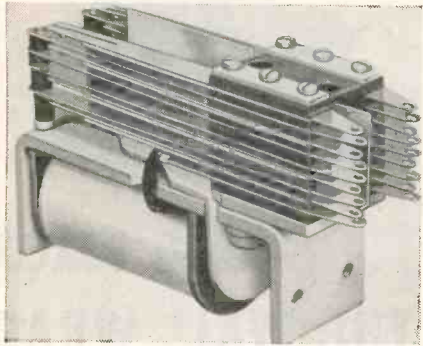

assemblies can be furnished in 1, 2 or 3 stacks, with various combinations, up to 16 springs. Coils are fungus treated and are available in voltage ranges from 1½ to 28 volts dc. Two sizes are available.

A miniature telephone-type relay known as the "MT" series is offered by Potter & Brumfield. The unit

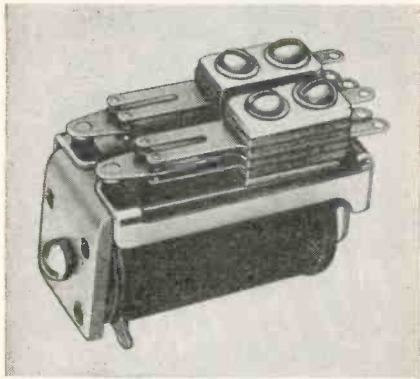

weighs 1½ oz, is compactly constructed for mounting in limited space, and is sensitive enough to operate on minute current. Twin contacts exert high contact pressure. Units are vibration-resistant.

### Record Carrier

THIS DEVICE consists of a specially-made spool for loading records on to an automatic phonograph. George Solkover of 2608 E. Marion St., Seattle 22, Wash., is the inventor. To load the records a flange is removed, and when the spool is loaded the flange is replaced. It is

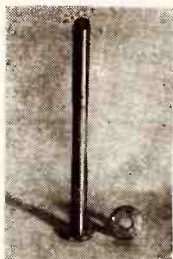

GET YOUR  
**FREE**  
COPY OF...

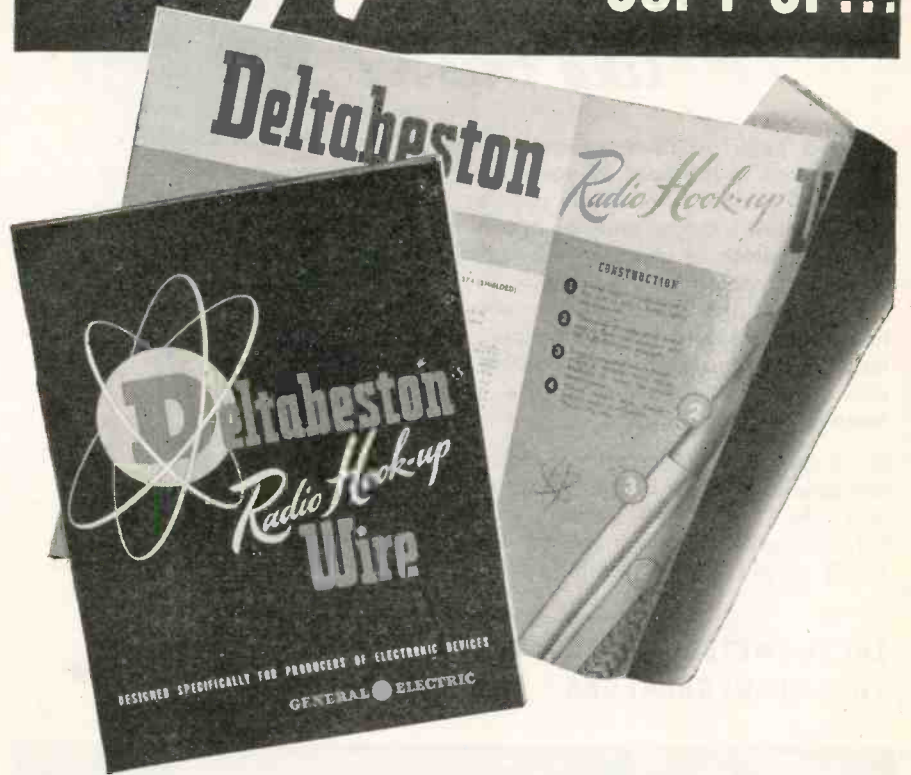

This attractive booklet is packed full of information, photographs and the latest specifications of G-E Deltabeston Radio Hook-up Wires. Complete specifications of low- and high-voltage types in braided and shielded constructions are presented in tabular form. Physical and electrical tests, braid patterns, shipping and packing information and other important data are included. Every purchasing agent, engineer and producer of electronic devices will find this booklet one of the most helpful references on Radio Hook-up Wires in the Electrical industry.

Deltabeston Radio Hook-up Wires are distributed nationally by Graybar Electric Company, G-E Supply Corp., and other G-E Merchandise Distributors.

FILL IN  
**THIS COUPON**  
We'll rush your  
copy to you

BUY WAR BONDS  
AND KEEP THEM

Section Y754-119  
Appliance and Merchandise Dept.  
General Electric Co.  
Bridgeport, Conn.

Please send me a Deltabeston Radio Hook-up Wire Booklet today.

Name.....

Company.....

Address.....

City.....State.....

**GENERAL**  **ELECTRIC**

## HOW CAN *you* USE AN INSTRUMENT *like this...?*



This H-B Red Top Thermo-Regulator has limitless applications in the field of accurate temperature control. It is used to eliminate guesswork, simplify supervision, increase the quantity or quality of production and aid in hundreds of other ways by holding, controlling or limiting temperatures—*automatically*. Ranges are from minus 35° to plus 350° F. and temperatures can be maintained to an accuracy of a fraction of a degree. Ranges may be set as specified or adjustable units may be set at any temperature point within the range and reset as frequently as desired.

Being specialists in temperature indication and control, we are able to give the benefit of our experience to anyone who asks—"What can I do with an instrument like this?" Why not write us today? H-B Instrument Company, 2524 North Broad Street, Philadelphia 32, Pennsylvania.

**THERMOMETERS · THERMOSTATS · RELAYS  
THERMO-REGULATORS · HYDROMETERS**



## MOVING AIR — 15 CUBIC FEET A MINUTE ONLY 2½" OF SPACE NEEDED

The blower illustrated, No. 1½", is one of many blower models manufactured by the L-R Mfg. Div. with C.F.M.'s at 8000 R.P.M. ranging from 15 to 270. These blowers will outperform many larger and heavier types formerly in use and where size and weight are factors, they are the answer to cooling problems presented by electronic tubes or circuit components in airborne communication units as well as in many industrial applications.

•WEIGHT: 2 oz.; CAPACITY: 15 C.F.M. at 8000 R.P.M.; CONSTRUCTION: Housing of high impact phenolic plastic. Wheel is turbo-type cadmium-plated steel; SIZE: 2½" long x 61/64" wide x 2½" high.

L-R MANUFACTURING DIVISION OF

The **RIPLY** Company

13 NEW LITCHFIELD STREET  
TORRINGTON, CONNECTICUT

THE  
**WESTERN  
UNION**  
TELEGRAPH CO.

... installs **SURCO**  
**THINWALL WRAP**  
*after Rigid Testing*

... the first uniformly  
high quality fine wire, plastic  
insulated with flame proofed  
yarn serving.

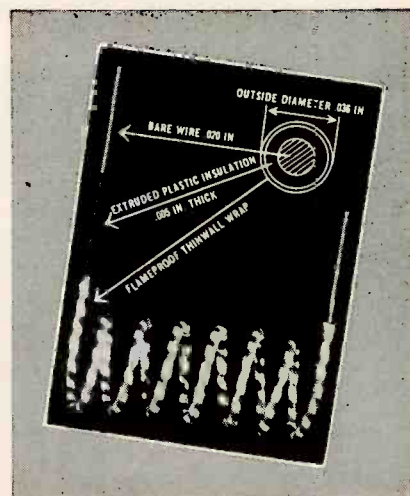

This photo of typical construction is absolutely unretouched

**Voltage Breakdown — 7000 Volts**  
(For spiraled section shown in photograph after 5 minutes in water)  
Insulation Resistance—30 Mcgs. Per 1000 Ft. at 60°F. (After 72 hrs. in water)

Here are Thinwall's Characteristics:  
High dielectric properties, Maximum saving in space and weight, Unlimited coding and identification, High temperature operation, Excellent abrasion resistance and toughness, Maximum protection against damage by soldering iron, Unusual flexibility at below freezing temperatures, Flameproof qualities, Good end and spot-stripping characteristics, Low cost.

Surco-American Thinwall Wrap is available in a wide variety of formulations finer sizes of wire and thinner insulations than shown above, for use where maximum performance under specific operating conditions is required.

**Surprenant**  
ELECTRICAL INSULATION CO.  
Dept. C 84 Purchase St., Boston 10, Mass.

then sleeved over the pin of the phonograph. The pin is slightly reduced in diameter to accommodate the spool. The device saves time in loading a phonograph; enables one to keep pre-selected records together as a unit; prevents marring or scratching of records; and prevents accidental dropping of a record. A special carrying case for extra groups of records (which are held together by the spool) is also available from Mr. Solkover.

### Milliohmmeter

MILLIOHMMETER No. 673-F is a new addition to a line of direct reading resistance measuring test

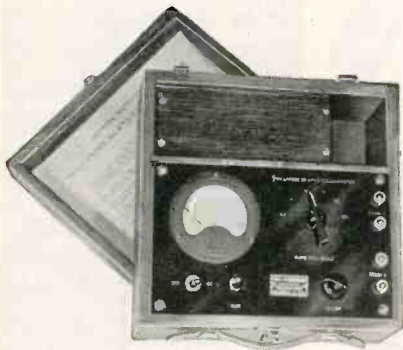

sets produced by the Shallcross Mfg. Co., Collingdale, Pa. The unit has linear scales. The six scales have ranges of: 0, 0.5, 1, 5, 10, 50 and 100 ohms full scale. This range bridges the gap between the regular Shallcross milliohmmeters used for low-resistance testing and the ordinary ohmmeters used for high-resistance measurements.

### Headphone Assembly

DESIGNED FOR comfort, efficiency and convenience is this assembly which consists of headphone (or headband) and a microphone. The lightweight, 100-ohm carbon-type microphone comes in a plastic clo-

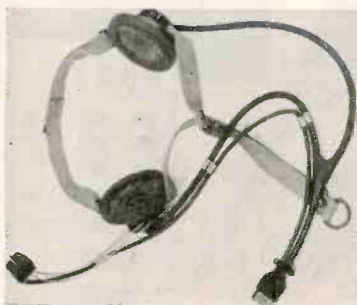

# AMPLIFIERS INTERCOMMS RECORDERS

## Write for This Important New CONCORD Presentation

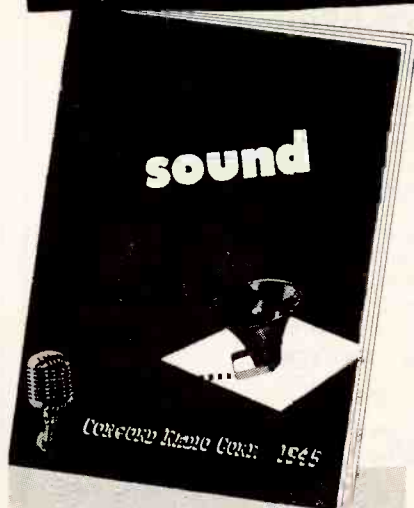

"Sound Equipment"—ready now—a new up-to-the-minute Concord folder illustrating and describing our complete line of Amplifiers, Intercomms and Recorders AVAILABLE FOR IMMEDIATE SHIPMENT.

*Amplifiers*—ranging in output ratings of 17 watts to 75 watts A.C.—also 6-volt units with and without built-in phonograph. Complete listing of speakers, microphones and essential equipment also included.

*Intercommunication Systems*—master and sub-station combinations for every purpose from 2 to 100 stations. Push button control, universal operation, "busy signal" and "call waiting light" features.

*Recording Equipment*—professional type for microphone recording, radio recording, transcriptions, public address.

*Engineering Service*—Our engineering service is at your command, without charge, to answer any and all "Sound Equipment" questions.

Mail the coupon below for your copy of "Sound Equipment" now.

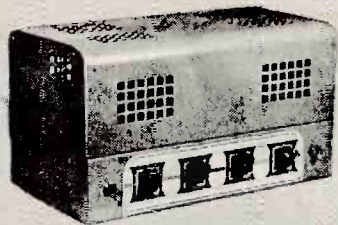

## CONCORD RADIO CORPORATION

Lafayette Radio Corporation

CHICAGO 7, ILL. ATLANTA 3, GA.

901 W. Jackson Blvd. 265 Peachtree Street

CONCORD RADIO CORP.

901 W. Jackson Blvd., Dept. G-75

Chicago 7, Illinois

Please send me at once copy of your new "Sound Equipment" folder.

Name.....

Address.....

City.....State.....



# THE NEW SPEED IRON

Patents Pending

THE SUCCESSOR TO THE  
ELECTRIC SOLDERING IRON

100 WATTS  
115 VOLTS  
60 CYCLE



IT'S REALLY  
**FAST!**  
SOLDERING HEAT  
IN 5 SECONDS!

It consists of a high amperage, low voltage transformer with its primary controlled by a trigger switch. To the secondary is connected the combination soldering tip and heating element. The tip is easily replaced and its flexibility permits forming into various shapes to reach difficult connections

This soldering tool is a must for your lab and for many special applications in the plant

Rugged, fast, powerful, built to give years of service

Write for descriptive literature

Prompt shipments being made on rated orders

PRICE \$12.95 F.O.B. EASTON

SEND ORDER TO

**WELLER MANUFACTURING CO.**

DEPT. E

EASTON, PA.

## SENSITIVE RELAYS BY SIGMA with MECHANICAL RUGGEDNESS and PHYSICAL ADAPTABILITY



\*HERMETICALLY SEALED

The Two basic Sigma Sensitive Relays, Series 4 and Series 5 are available in a wide choice of mounting styles. Type 5 relays have both exceptional sensitivity and extreme ruggedness (withstand 500g. shocks without damage).

Some advanced design features developed for wartime requirements may be unnecessary for peacetime applications. But the wealth of know-how accumulated during the development process will prove of inestimable value in solving your postwar control problems.

**Sigma Instruments, Inc.**

62 CEYLON ST., BOSTON 21, MASS.

SENSITIVE  
RELAYS

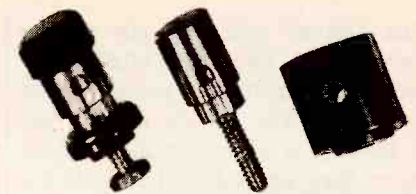

THERE IS NO  
SUBSTITUTE  
FOR EBY  
SPRING BINDING POSTS

From the product designer through to final assembly and use in the field, the Eby Spring Binding Post line offers top service based on dependability.

The spring binding post offers unique advantages that can't be duplicated:

1. No screw cap to tighten or come loose with vibration.
2. Constant, even pressure on the wire at all times in all positions.
3. Easy one-hand feeding of wire into the post.
4. Corrosion - resistant, long-life springs.
5. Complete range of sizes, stem lengths, and accessories for every application.

Replace with Eby Spring Binding Posts — Write today.

HUGH H.

**EBY**

INCORPORATED  
18 W. CHELTENAVE.  
PHILADELPHIA, PA.



sure and is assembled with a swivel boom. The complete assembly weighs less than 12 ounces. A chin slide clasp adjusts ear cushions. Aviometer Corp., 370 West 35th St., New York 1, N. Y.

### Driver Unit

THESE PERMANENT-MAGNET driver units feature molded diaphragm flexing surfaces, heatproof voice coil suspension, and hermetically-sealed dust covers. Covers are spun over the entire unit structure, resulting in permanent waterproof protection under all adverse conditions. The voice coil assembly is permanently rim-centered in the magnetic gap and neither shock nor vibration will shift its relative po-



sition with respect to the gap walls. The manufacturer states such positive positioning of the coil assembly permits using increased magnetic flux density in the gap. Two types of units available include Model PAH rated at 25 watts, 15 ohms impedance, frequency range 100 to 6000 cycles, dimensions 5½ x 5 in. and weight 9 lb. Model SAH differs only in that its dimensions are 4½ x 5 in. and weight is 5 lb. University Laboratories, 225 Varick St., New York 14, N. Y.

### Decade Circuit Components

THESE DECADE UNITS make immediately available almost any desired value or combination of values covering capacitance, inductance, resistance, transformer ratios, etc., over a wide range. The units will

# 150°

## BELOW ZERO

In a KOLD-HOLD electrical refrigeration cabinet you can process metal parts and tools consistently at closely controlled temperatures as low as 150 deg. below zero—much lower than can be attained by the use of dry ice and the lowest temperature yet commercially available. This unit is especially designed for hardening steel tools, making expansion fits on close tolerance assemblies, for experimental work, and for product research.

These cabinets are built in two sizes, one having a work capacity of 5 cu. ft. and the other a capacity of 11 cu. ft.

Write for further specifications and quotation.

**KOLD-HOLD MANUFACTURING COMPANY**  
446 NORTH GRAND AVE. • LANSING 4, MICH.

# KOLD-HOLD

★ **Now Available:**  
**CREI GROUP**  
**TRAINING**

**A Planned Program to  
 Modernize the Technical  
 Knowledge of Your  
 Employees Through  
 Training for Professional  
 Self-Improvement**

★ **Prepare your technical  
 staff to meet the challenge of  
 post-war radio-electronic  
 technological demands.**

If your organization plans engagement in post-war radio-electronics, your technical personnel must know FM—television—Ultra High Frequency Techniques, and all other phases of war-developed electronics technology; and, of course, a thorough and complete knowledge of the fundamentals of practical radio-electronics engineering.

**The CREI "Employers' Plan"  
 for group training will:**

1. Increase the technical abilities of your radio-electronics personnel.
2. Enable them to perform their duties more efficiently and in less time.
3. Increase the value of their services to your organization.

No company time is required for this training . . . it is accomplished by spare-time, home study.

The CREI "Employers' Plan" is useful for the up-grading of technical personnel in manufacturing, AM, FM, and television broadcasting, communications, industrial electronics, including the following:

Engineers	Testers
Engineering Aides	Technicians
Laboratory Assistants	Field Servicemen
Inspectors	Installers
	Maintenance Men

The CREI "employers' Plan" for group training is tailored to meet each individual organization's requirements.

Your request will promptly bring an outline of the plan, as now in use with other organizations, and intimate details will follow when your particular needs are known. No obligation or cost, of course.

**CAPITOL RADIO**  
**Engineering Institute**

E. H. RIETZKE, President

Home Study Courses in Practical Radio-Electronics Engineering for Professional Self-Improvement

Dept. E-7 3224—16th St., N.W.  
 WASHINGTON 10, D. C.

Contractors to the U. S. Navy—U. S. Coast Guard—Canadian Broadcasting Corp. Producers of Well-trained Technical Radiomen for Industry.



**ALDEN**  
 FOR GRAPHIC RECORDING OF ANY KIND

Our cumulative skills in designing and producing radio components are now applied to making equipment that covers the entire field of facsimile.

Practically all types and sizes of facsimile and impulse recording equipment of our manufacture are proving themselves in actual service such as found in war communications—service that has given Alden recorders a PRACTICAL quality that under ordinary conditions would not be obtained in years of engineering with limited application.

**Alden recorders use all the varied mediums:  
 Photographic paper, film, electrolytic paper,  
 teledeltos and ink.**

By covering the entire field we mean making equipment for:—

1. Photographic pictures of reasonably high resolution (such as war pictures now in news.)
2. Continuous recording—on a type of equipment whose value is proven on National and International news circuits—using Alfax paper.
3. High-Speed Signal Analysis.  
 Alfax paper has made this possible for various laboratories and government agencies. Other equipments have employed Teledeltos paper for message work and other purposes.
4. Outlying posts, where servicing equipment is impossible, or where radio or wire links are poor, through the use of Alden Tape Recorders (recording medium, ink). Recorders operate with a minimum of trouble and adjustment.

We do not want to miss the opportunity to discuss with you whatever interest you may have in facsimile. Write—or better still, visit us by appointment.

**ALDEN PRODUCTS COMPANY, BROCKTON (64E) MASS.**

Toroids..

by  
DX

Doughnut Coils for electronic and telephone purposes.  
 High Permeability Cores are hydrogen annealed and heat treated by a special process developed by DX engineers. Send us your "specs" today—ample production facilities for immediate delivery.

DX

COILS

"the heart of a good receiver"

DX RADIO PRODUCTS CO.

GENERAL OFFICES 1200 N. CLAREMONT AVE., CHICAGO 22, ILL., U.S.A.





dissipate heat and power and stand up indefinitely under actual operating conditions. The various components of this unit may be included in actual circuits necessary for testing various types of equipment. Harvey-Wells Electronics Inc., Southbridge, Mass.

### Slide-Rule

ALL THE VALUES of the regular slide rule, plus 8 mathematical tables, are included in a new slide-rule (designated Multi-Slide Rule) designed by Standard Transformer

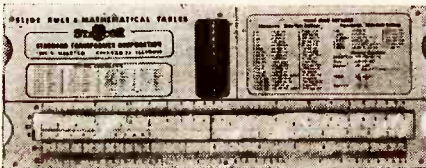

Corp. (1500 N. Halsted, Chicago 22, Ill.) who will sell the rule together with a carrying case at a cost of \$1.00. The rule is made of durable stock, clear print and has a transparent plastic indicator.

### Literature

**GE Literature.** Four separate pieces of literature from General Electric Company, Schenectady, N. Y., include: Bulletin GEA-4265 which describes voltmeters, milliammeters and microammeters (types DO-45, DO-46 and DO-55) which are 3½-inch a-c rectifier type electric instruments for panel mountings. Bulletin GEA-4363 describes thickness gages (types A, B and C) which are used to measure thickness of non-mag-



# Saving MAN HOURS in thousands of American plants

## in the DEBURRING AND FINISHING OF small PARTS

### FOREDOM FLEXIBLE SHAFT MACHINES

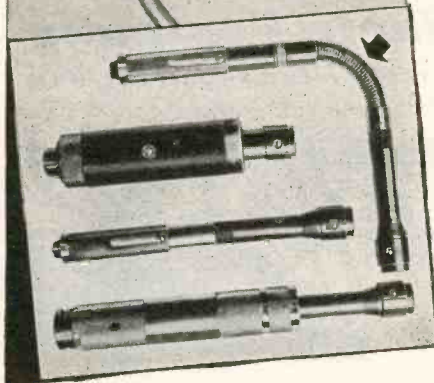
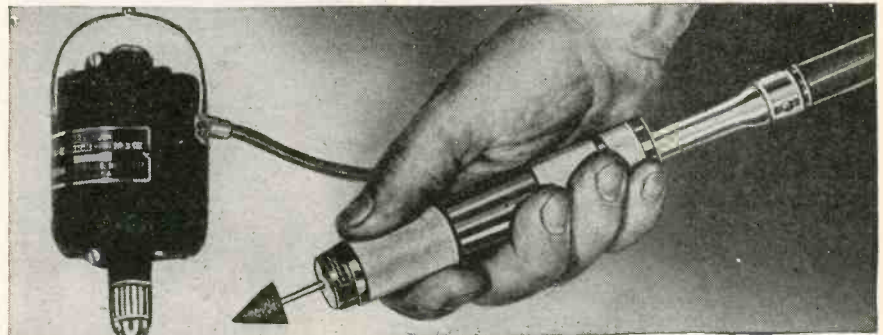

**4 Quickly interchangeable handpiece types—pencil sizes and larger—some with flexible wrist—see arrow.**



Another ForeDOM Time-Saver

### GRINDING KIT



Model 111

One of ForeDOM's complete line of versatile utility grinding kits preferred by so many plants for emergency and maintenance needs. You too will find it pays to spot them liberally about your plant. Pencil-size handpiece facilitates getting into tight corners for touching up production set-ups. Complete with accessories \$23.50.

**FOREDOM ELECTRIC CO.**  
27 Park Place, New York 7, N. Y.



Here's versatility plus in any man's language. Let ForeDOM solve your production problems too. Pencil-size handpieces for the hard-to-reach places. Larger, ball-bearing handpieces for the heavier jobs, all quickly interchangeable. Flexible shafts which really ARE FLEXIBLE.

### 3 WAYS Right!

- 1 For de-burring, grinding, finishing, polishing and other light production jobs—particularly valuable on irregularly shaped parts.
- 2 In tool and die departments, for grinding, finishing and touching up dies, molds, jigs, etc.
- 3 For maintenance and emergency needs—touching up set-ups without disassembly, removing high spots on gears, identification marking of equipment, etc.

THOUSANDS OF PLANTS USE FOREDOMS, including Ford, General Motors, Chrysler, Nash-Kelvinator, Jack & Heintz, Sperry Gyroscope, Bendix, Westinghouse, etc.

Models from \$17.50 to \$48.75. Catalog No. 59 shows complete line and many uses—may point the way to solving some of today's production and maintenance problems. Write for your copy.

Order from your regular Mill Supply House or direct

**FOREDOM ELECTRIC CO.**  
27 Park Place, New York 7, N. Y.  
Please send me your new catalog No. 59 showing the different uses of ForeDOM Flexible shaft Machines.

Name .....  
Address .....  
City ..... Zone .... State .....

Have you a High  
Temperature  
Capacitor  
Application?



**PLASTICONS\***  
Operate at **256° F.**

Plasticon Types AS are silicone impregnated plastic film dielectric capacitors. They will operate from  $-80^{\circ}\text{F.}$  to  $+256^{\circ}\text{F.}$  with less than 10% capacitance change. Plasticons are small in size as they are not "voltage derated."



**Condenser  
Products Company**

1375 NORTH BRANCH STREET • CHICAGO 22, ILLINOIS

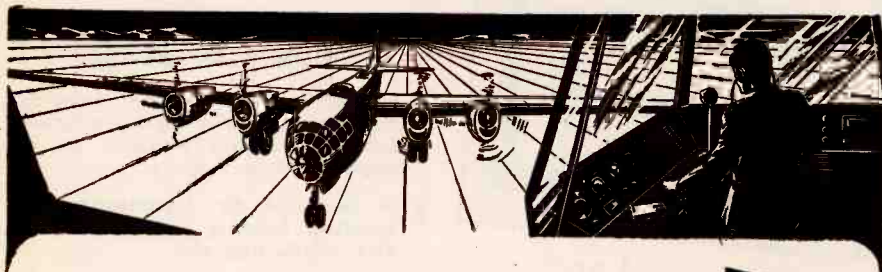

An Invitation to All Electrical Designers to  
**TRY SILVER GRAPHALLOY**

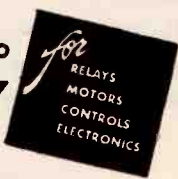

**FOR BRUSHES**

High current density, low contact drop, low electrical noise, and self-lubrication are characteristics of this silver-impregnated molded graphite that may be the answer to your electrical brush problems.

**FOR CONTACTS**

Low contact resistance and non-welding when breaking surge currents are inherent properties of this unique combination of conductive silver and self-lubricating graphite.

SAMPLES of Silver Graphalloy will be gladly furnished for test on your applications.

Silver Graphalloy is usually silver plated to permit easy soldering to leaf springs or holders. Why not WRITE NOW for your test samples?

**GRAPHITE METALLIZING CORPORATION**

1055 NEPPERHAN AVE • YONKERS, NEW YORK



SLIP-RING AND COMMUTATOR BRUSHES AND CONTACTS

**SUPREME**

TESTING INSTRUMENTS

**"WORTH  
WAITING  
FOR"**

● Though Supreme's total current production is still needed by and being sent to our Armed Forces, we are planning extensively in our engineering and production departments to bring you your post-war Supreme Testing Equipment at the earliest possible date. Instruments incorporating radical departures and improvements . . . the result of the experience and know-how gained through over sixteen years of producing instruments proved "Supreme by Comparison."

● These dependably accurate Supreme Testing Instruments will be worth waiting for.

**WATCH**

NEXT MONTH

for announcement of Supreme's new Model 565 Vacuum Tube Voltmeter.

SUPREME INSTRUMENTS CORP.  
Greenwood, Miss., U. S. A.

netic materials. Bulletin GEA-3682B is a 20-page booklet which illustrates and describes sintered-alnico magnets which are compact and permanently stable and are available in a variety of shapes and sizes. The fourth and last Bulletin GEA-4324 describes electric tachometers used to measure rotational speeds from 1 to 60,000 rpm, and linear speeds which can be measured in terms of rpm.

**Electronic Heaters.** Application of Allis-Chalmers vacuum-tube electronic heaters for both induction heating of metals and dielectric heating of non-metallic materials is explained in a 4-page bulletin, No. B6372, issued by Allis-Chalmers Mfg. Co., Milwaukee 1, Wis.

**House Organ.** Westinghouse Newsfront is the title of a new monthly report on the highlights of Westinghouse Electric Corporation's scientific research, engineering, and production. Vol. 1, No. 1, is available. Write Westinghouse Newsfront, 306 4th Ave., Box 1017, Pittsburgh 30, Pa.

**Fastenings.** New information has been added on the many types of self-tapping screws, socket screws, and other fastening devices in a new edition of Parker-Kalon's Fastening Catalog Data Book. 204 Varick St., New York 14, N. Y.

**Radio Components.** A Partial Directory of Radio Components is the title of a 4-page bulletin which lists 500 different items in 30 classifications as manufactured by the Alden Products Co., 117 N. Main St., Brockton 64, Mass.

**Liquid Polystyrene.** A new technical bulletin contains data on the dielectric constant, power and loss factors, as well as electronic characteristics of No. 912 Polystyrene (a pure polystyrene in solution form). American Phenolic Corp., 1830 South 54th Ave., Chicago 50, Ill.

**Cable Accessories.** Bulletin No. 25-A is a 4-page folder which illustrates and describes cable accessories from Andrew Co., 363 East 75th St., Chicago 19, Ill.

## MEMO

To: **MR. MANUFACTURER**  
c.c. **MR. SALES MANAGER**  
c.c. **MR. CHIEF ENGINEER**  
From: **ATLANTIC ENGINEERING PRODUCTS**  
Subject: **POST-WAR SALES ENGINEERING**

If you believe, as we do, that Post War selling to the electronic manufacturer will require a better understanding of the product, plus a more competent, aggressive service; then you must be interested in our

### THREE POINT SALES PROGRAM

#### 1. SELLING THE RIGHT PROSPECT

Our years of experience have given us a thorough knowledge of the Eastern Electronic Manufacturer. We are well acquainted in the New York metropolitan area and have acquired a reputation for honest and intelligent representation.

#### 2. MAINTENANCE OF A SAMPLE SHOP

To properly serve the customer, we maintain a well equipped model shop under expert supervision for making samples according to customers' specifications, from your standard tools and parts. After approval by the customer, the item will go into production with a minimum loss of time.

Our engineering staff is experienced in the design, production, and application of:

**RELAYS...SOLENOIDS...TRANSFORMERS**  
**VACUUM and GAS TUBES...ELECTRONIC**  
**EQUIPMENT and DEVICES**

#### 3. FIELD ENGINEERING SERVICE

The men who will represent you are competent sales engineers. They will be able to interpret customers' ideas. They will act as your consultants with the engineering department of the prospect. We are also thoroughly competent to handle the sales to jobbers as well. We are young enough to be energetic and aggressive, old enough to have complete pre-war experience, sound judgment, and reliability.

This service is being offered to not more than two or three manufacturers who believe they need more adequate representation in the New York metropolitan area and who are interested in a sales organization which will represent them as a branch house. If you are interested, write us at no obligation.

# ATLANTIC ENGINEERING PRODUCTS

136 LIBERTY STREET, NEW YORK 6, N. Y.

Check These Exclusive

**KWIKHEAT**

**SOLDERING**

**IRON** Advantages!



- ★ SAVES TIPS
- ★ SAVES TIME
- ★ SAVES EFFORT
- ★ SAVES WEIGHT
- ★ SAVES CURRENT
- ★ SAVES THE IRON

**HOT IN 90 SECONDS  
READY FOR USE . . . !**

Kwikheat's built-in thermostat maintains proper, even heat for most efficient, economical operation. Can't overheat . . . saves tips . . . requires less retinning. Powerful, 225 watts, yet light weight (14 oz.), well-balanced with cool, protecting handle. Choice of # 0, 1, 2 or 3 tip..\$11.00

**6 TIP STYLES**

Interchangeable

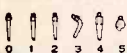

... ASK YOUR JOBBER!

Miscellanea Vol. XIX, No. 10 of The General Radio Experimenter contains the following articles: "High-Frequency Compensation for Amplifiers," "Dynamic Balancing in the Field with the Aid of a Stroboscope," "The Use of Variacs at Voltages Above 230" and "Rubber Glove Tester Uses Variac." General Radio Co., 275 Massachusetts Ave., Cambridge 39, Mass.

**Tube Manual.** A new 1945 Catalog and Manual, available for 25 cents, contains information on all tubes manufactured by Taylor Tubes, Inc., 2312 Wabansia Ave., Chicago 47, Ill. Some 22 pages of the manual are devoted entirely to tube characteristics, and a large portion of the catalog contains technical information on transmitters and tubes.

**Reference List of Tube Types.** To assist design engineers in the selection of tubes for specific applications there is available a handy "pin up" chart of recommended tube types. Sylvania Electric Products, Inc., 500 Fifth Ave., New York 18, N. Y.

**Plastic Molding.** A 16-page booklet entitled "A Businessman's Guide to the Molding of Plastics" contains charts and photographs. A good portion of the booklet deals with material selection, design, mold-making, and production. Also contained in the booklet is data on the facilities, equipment and the production capacity of Kurz-Kasch, Inc., Dept. 7G, 1415 S. Broadway, Dayton 1, Ohio.

**Replacement Capacitor Catalog.** Catalog No. 195 contains complete data on capacitances, sizes and prices of Cornell-Dubilier (South Plainfield, N. J.) electrolytic capacitors.

**Industrial Sound.** A 66-page pamphlet has been compiled giving a comprehensive picture of the installation and most efficient use of equipment for transmitting sound as an operational and morale item in war plants. The title of the pamphlet is "Guide to Industrial Sound." It is sponsored by The Industry Advisory Committee for Industrial Sound Equipment and The

**HERE TODAY  
AND HERE TO  
STAY . . . .**

**New Standards of  
Brazing Speed, Quality  
and Economy set by**

**SIL-FOS and  
EASY-FLO**

These two low temperature silver brazing alloys, created by Handy & Harman have made brazing one of the fastest production operations... They have set new standards for strength and other vital properties of brazed joints... They have created a new conception of brazing reliability and economy... They have made practical the labor-metal-cost-saving brazed construction now used in fabricating a wide variety of parts formerly cast, forged, machined from the solid, bolted, threaded or riveted.

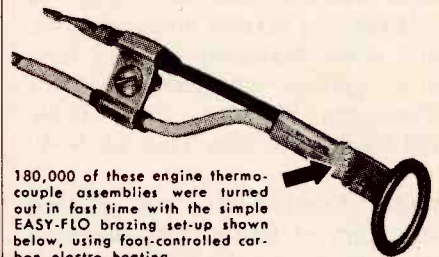

180,000 of these engine thermo-couple assemblies were turned out in fast time with the simple EASY-FLO brazing set-up shown below, using foot-controlled carbon electro heating.



Start now to put your brazing, old and new, on the fast, profitable SIL-FOS and EASY-FLO basis.

**GET FULL DETAILS BULLETIN 12-A**

Write for your copy of this interesting and instructive bulletin today.



**HANDY & HARMAN**

82 FULTON ST., NEW YORK 7, N. Y.

Bridgeport, Conn. • Chicago 31 • Los Angeles, Cal.  
Providence, R. I. • Toronto, Canada  
Agents in Principal Cities

Find the help  
you need  
in these 3  
**McGRAW-HILL  
BOOKS**



• 10 days examination  
on approval

**INTRODUCTION TO MICROWAVES**

By Dr. Simon Ramo, General Electric Company; Union College, Schenectady, N. Y. 135 pages, 5 1/4 x 8 1/4, \$1.75.

Here is a complete non-mathematical description of the physical basis for all microwave phenomena, for engineers and industrial men who desire an understanding of microwaves and their application. The book covers transit-time electronics, velocity modulation, radiation, transmission lines, resonant cavities and wave-guides and correlates microwaves with lower frequency electricity in simple language and with a large number of explanatory diagrams. Presents for the first time the basic concepts of microwaves and their relation to the lower electricity range in such a manner that in a few hours time, any one may understand the principles involved and their application.

**INDUSTRIAL ELECTRONIC CONTROL**

A Guide to the Understanding of Electronic Control Circuits for Industrial Use.

By W. D. Cockrell, Industrial Engineering Divisions, General Electric Co. 247 pages, 175 illustrations, charts, and tables, \$2.50.

The first book written especially for the practical electrical man in industry who desires a basic working knowledge of electronic control. In a direct, non-mathematical treatment, it gives you fundamental facts of electron tube operation and practical applications of tubes in basic circuits of industrial electronic control apparatus. Here is the information needed by the engineer for quick understanding of the special aspects of this new and rapidly growing field.

**THEORY AND APPLICATIONS OF ELECTRON TUBES**

By Herbert J. Reich, Professor of Electrical Engineering, University of Illinois. Second edition, 716 pages, 640 illustrations, \$5.00.

Gives a thorough groundwork in tube and circuit theory with emphasis on fundamental principles and their use in many applications in industrial electronics, communications, power, and measurements. Assembling and coordinating present knowledge of theory and application of electron tubes, the book covers its subject authoritatively and in detail, from the fundamental principles of atomic structure, excitation, ionization, radiation, and emission, to practical material on the design of voltage and power amplifiers, phototube circuits, power-control circuits, power supplies, and measuring instruments.

**Send this McGRAW-HILL coupon**

McGraw-Hill Book Co., 330 W. 42 St., N. Y. C. 18

Send me the books checked below for 10 days' examination on approval. In 10 days I will pay for books, plus few cents postage, or return them postpaid. (Postage paid on cash orders.)

- Ramo—Introduction to Microwaves, \$1.75
- Cockrell—Industrial Electronic Control, \$2.50
- Reich—Theory and Applications of Electron Tubes, \$5.00

Name .....

Address .....

City and State .....

Company .....

Position ..... (Books sent on approval in the United States only.)

BACK THE INVASION — BUY MORE BONDS NOW!

Engineers, please note:-  
**211 TYPES of DIALCO  
PILOT LIGHTS**  
provide rapid  
solutions to  
every problem

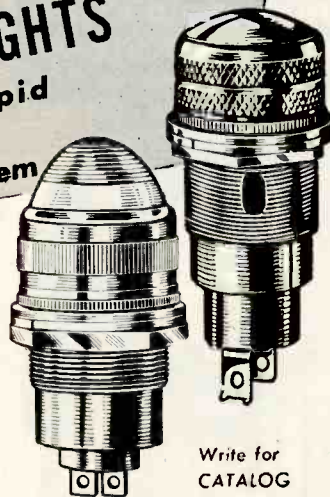

Write for  
CATALOG

Consider your Pilot Light problem solved! The extensive Dialco line covers every conceivable application — Aircraft, Marine, Electrical, Electronic, Radio, and Industrial. We are geared to supply COMPLETE ASSEMBLIES, housing required G.E. or Westinghouse Lamps. Special emphasis on NEON applications. Send data for estimates, suggestions, and samples.

*World's Largest Manufacturer of Pilot Lights*

**DIALCO**

**DIAL LIGHT CO.** of America, Inc.  
900 BROADWAY • NEW YORK 3, N. Y.  
Telephone: ALgonquin 4-5180-1-2-3

BACK THE INVASION — BUY MORE BONDS NOW!

THE  
**ANSWER**  
TO YOUR  
**CONDENSER**  
*Requirements*

**...is in YOUR HANDS**

when you use the handy BUD Catalog! In it, you find not only BUD precision-built Condensers for every application, but an almost limitless range of the latest-type radio and electronic parts. BUD keeps your requirements in hand by supplying them promptly. Build with BUD... send coupon below for your catalog today!

**BUD RADIO, INC.**  
Cleveland 3, Ohio

**BUD RADIO, INC.** Dept. D Cleveland 3, O.  
Send me your new BUD Catalog, no obligation attached.  
Name .....

Address .....

City ..... State .....

# HARVEY

has test equipment  
for immediate delivery\*



**WESTON MODEL 697**  
Volt-Ohm-Milliammeter

A small, lightweight multi-range master test unit. Ideal for production tests on motors, electrical equipment, and parts, as well as laboratory work and general maintenance. Ranges have been carefully selected to meet many measuring requirements. . . . \$24.00

**R. C. P. MODEL 804**  
Tube, Battery and Set Tester

A portable tester equipped for direct testing of all vacuum tubes as well as old and new types of regular receiving tubes, rectifiers, etc. Also tests condensers, batteries, etc. Complete with sturdy wood case; ready for operation on 105-135 volts, 50-60 cycles. . . . \$84.50

**R. C. A. MODEL 160 B**  
Portable Oscillograph

May be used for engine-pressure measurements and similar applications, besides standard oscillograph functions. Amplifiers have unusually wide frequency range. The 5" screen gives an easily read image. . . . \$142.50

## Also

Precision Model 832 S—AC-DC Tester . \$18.65  
R. C. P. Model 442— Volt-Ohm-Milliammeter . . . 21.00  
Electronic Design Model 100—Voltahmist 48.00  
Jackson Model 652—Audio Oscillator . . . 88.50

\*On AA-5 Priority or better

HARVEY is prepared to provide information on all Standard Instruments . . .

R. C. A.  
WESTON  
HICKOK  
SIMPSON  
G. E.

TRIPLETT  
SUPREME  
R. C. P.  
PRECISION  
JACKSON

. . . and others

Reasonably prompt deliveries

Telephone: LOnacre 3-1800

**RADIO COMPANY**  
**HARVEY**

102 WEST 43rd ST., NEW YORK 18, N. Y.

Radio and Radar Division of the War Production Board and is available for 15 cents from the Superintendent of Documents, U. S. Government Printing Office, Washington, D. C.

**Resistors.** Koolohm type resistors having the "tropicalized"-glazed outer protective shell and new type of moisture-proof end seals are described in a new catalog which also contains data on 5, 10, 25, 50 and 120-watt fixed types, as well as 10-watt adjustable types. Sprague Products Co., North Adams, Mass.

**Tropicalized Wax.** This 6-page folder discusses tropicalized wax (fungus resistant) and tells about results of tests made on this manufacturer's products. Four pages of the folder show illustrations of Agar test plates of wax heated at 250 deg F. Zophar Mills, Inc., 112 26th St., Brooklyn 32, N. Y.

**Research Institute of America.** "Rehiring Your Company's Veterans" is the title of a recent Research Institute analysis on the subject. The booklet is timely and authoritative and tends to answer most of the questions pertaining to veterans employment or re-employment. It is an analysis which every employer should read. Four chapters of particular interest are "Your Rehiring Obligations Under the Law," "Where to Get Help in Retraining Veterans," "The Meaning of Changed Circumstances," and "Solving Seniority Questions." Copies may be obtained by writing the Public Relations Dept., Research Institute of America, 292 Madison Ave., New York 17, N. Y.

**Electronic Controls.** Bulletin No. Z6300 (supersedes Bulletin No. Z6200) is a 12-page bulletin which contains a condensed listing of electronic controls available from Wheelco Instruments Co., Harrison & Peoria Sts., Chicago 1, Ill.

**Silicon Steels.** Core loss data, magnetization curves and permeability curves are given in a new technical bulletin which confines itself to brief essential data on the several grades of Republic silicon steels most generally used at this time. The bulletin is prepared

There is no  
substitute for

# PRECISION

in metal parts  
fabrication

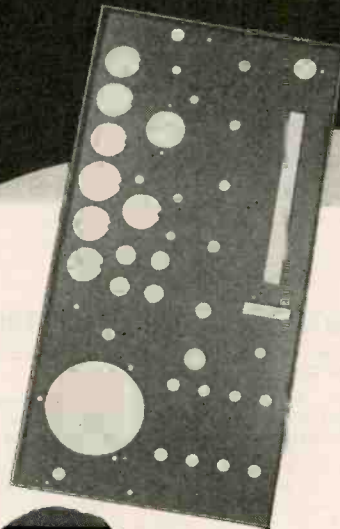

"This instrument panel is representative of the accuracy and tolerance specifications regularly handled by OLYMPIC. Critical electronic applications are ordinary production here."

Mass production methods demand high dimensional accuracy today, particularly where replacement parts must be readily interchangeable. The experience and manufacturing techniques of OLYMPIC assure strict adherence to dimensional limits in sheet metal working and fabrication.

OLYMPIC metal fabrication facilities are available for the accurate and precise fulfillment of your needs. Stamping, forming, tooling, turning, drawing, grinding, soldering, welding or brazing, etc.—all are accomplished to your exact specifications. Any finish—painting or plating—as required.



**OLYMPIC**  
TOOL & MFG. CO., INC.

39 CHAMBERS ST.  
NEW YORK 7, N. Y.

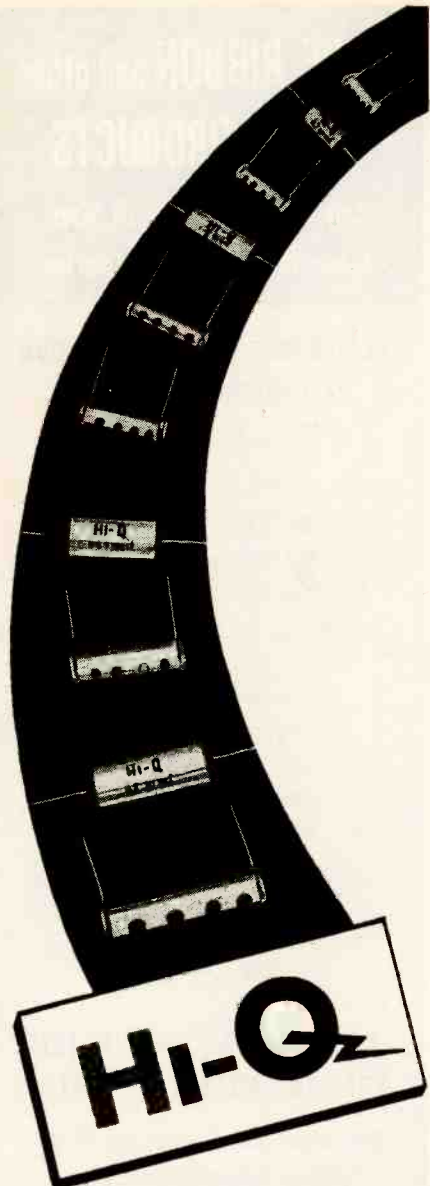

**HI-Q**

## CERAMIC CAPACITORS

● Available in Temperature Compensating and Hi-K type. Dielectric factors 19 to over 1200. Solid Silver condenser plates, non-aging and non-corrosive, gauged to thousandths of an inch, fused for long life performance.

Hi-Dielectric Enamel Finish withstands mechanical and thermal shock.

Color coded for accuracy in identification.

**ELECTRICAL  
REACTANCE  
CORPORATION  
FRANKLINVILLE, N. Y.**

## NEW! *Pressuregraph* LINEAR PRESSURE • TIME-CURVE INDICATOR

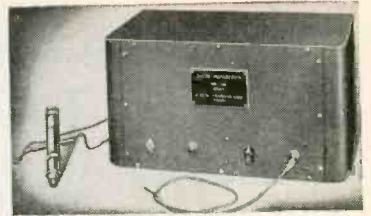

Indicates in linear response, on screen of cathode ray oscillograph, the pressure-time-curve of any internal combustion engine, pump, airline, or other pressure system where pressure measurements are desired. Static—also dynamic pressure up to 100,000 R.P.M.

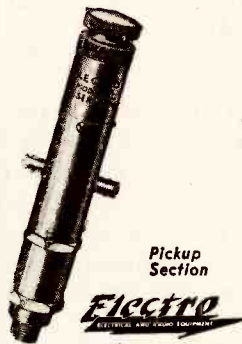

Pickup  
Section

**ELECTRO**  
ELECTRICAL AND RADIO EQUIPMENT

### Simple operation—Only one control

In operation the pick-up section (at left) is inserted in cylinder, chamber of airline, etc. The pick-up response is transmitted after amplification to screen of oscillograph. Now used for pressure-time-curve of C.F.R. aviation fuel test engines, on 2-cycle engines for pressure-time-curve of main cylinder or crankcase, and for Diesel engines and many other applications.

For complete information write

**ELECTRO PRODUCTS LABORATORIES**  
549 W. RANDOLPH ST., CHICAGO 6, ILL. Phone STATE 7444



*Leads the way*

**New! De Luxe Phone Jacks**  
Feature Many Special Advantages



**DESIGNED FOR  
GREATER EFFICIENCY**

ICA leadership is embodied in these new jacks having the following features: Constructed of an accurate automatic-screw-machine brass body; assembled with molded bakelite separators. Designed to give maximum protection against creepage, moisture and other foreign matter. By use of arch springs, the small size and light weight of the jack enables it to be used in confined spaces, reducing the chances of electrical interaction in critical circuits. Contacts are made of phosphor bronze, silver-plated. Furnished in 3 styles:—No. 1920, Single Open Circuit; No. 1921, Single Closed Circuit; No. 1922, Three-way Microphone Jack.

## LEADERSHIP

IN DESIGN AND MANUFACTURE  
OF RADIO-ELECTRONIC PRODUCTS

The outstanding production records of Insuline have twice been commended by the Army and Navy. New designs, new products, new manufacturing methods are constantly being devised, so that after V-Day it will still be true that, in the Radio-Electronics field, "ICA Leads the Way."

Write for 48-page Catalogue describing the extensive line of ICA Radio-Electronic Products . . . Also 8-page brochure presenting the ICA Manufacturing facilities.



**INSULINE**  
CORPORATION OF AMERICA  
INSULINE BUILDING · LONG ISLAND CITY, N. Y.



# IN-RES-CO RESISTORS

can promote

## PEACE-TIME SALES APPEAL



Electronically-controlled products, equipment, instruments and appliances will undoubtedly typify the post-war era. IN-RES-CO types RL and SL, non-inductive resistors, are typical of those which will meet future requirements for compact units maintaining accuracy under continuous operation.

Type RL has a maximum resistance of 500,000 ohms, is rated at  $\frac{1}{2}$  watt, and measures  $\frac{1}{2}$ " high and  $\frac{1}{2}$ " in diameter. Type SL has 1 watt rating, a maximum resistance of 1 megohm, and is 1" high and  $\frac{1}{2}$ " in diameter.

These IN-RES-CO resistors, by their design advantages and long-life capabilities, will serve to strengthen trade-name goodwill and sales potentials. A copy of the new IN-RES-CO catalog will be sent promptly on request on company letterhead; write today.

## INSTRUMENT RESISTORS CO.



25 AMITY STREET  
LITTLE FALLS, N. J.

for the electrical manufacturing industry and is available from Republic Steel Corp., Republic Bldg., Cleveland 1, Ohio.

**Induction Heating.** Two separate booklets available on this subject include a reprint from *The Iron Age* entitled "Induction Heating, A History of Its Development" and Bulletin No. 25 entitled "Induction Heating & Melting in Industry." This 28-page booklet contains illustrations and descriptive data on equipment available from Ajax Electrothermic Corp. Ajax Park, Trenton 5, N. J.

**Background Data.** Alden Products Company (117 North Main St., Brockton 64, Mass.) have issued a 44-page, nicely bound catalog which tells about their facilities for designing, engineering and manufacturing complete sub-assemblies and items difficult to obtain. The booklet contains many illustrations.

**Radio Parts.** Catalog No. U.C.-44 has been prepared essentially to provide the buyer of Utah parts with all of the important technical data pertaining to these products. The catalog is spiral bound and contains 50 pages of illustration and descriptive matter. Utah Radio Products Co., 812-20 Orleans St., Chicago 10, Ill.

**X-Ray Diffraction.** "X-Ray Diffraction Apparatus and Applications" is the title of a 26-page booklet (Bulletin No. 1245) which contains a section devoted to the application of x-ray diffraction and gives typical diffraction radiographs and their interpretation. Picker X-ray Corp., 300 Fourth Ave., New York, N. Y.

**Selenium Rectifiers.** Bulletin No. RDP-107 is intended primarily for design engineers who use rectifiers or other sources of direct current in their products. It is an engineering manual and gives standard element specifications. Fansteel Metallurgical Corp., Rectifier Div., North Chicago, Ill.

# WIRE, RIBBON and other METAL PRODUCTS

- Smaller than Commercial Sizes
- Closer than Commercial Tolerances

PLATINUM · RHODIUM · IRIIDIUM  
PALLADIUM · RUTHENIUM  
and ALLOYS

Commercial Purity and High Purity  
WIRE, SHEET, FOIL, TUBING

- Wire for Resistance Thermometers
- Rhodium Electroplating Solutions
- Platinum for Electronic Tubes
- Rhodium First Surface Mirrors
- Alloys for Contact Points
- Wires for Detonator Fuses
- Dental Metals and Alloys
- Wires for Thermocouples
- Tubing for Ink Devices
- Wire for Pirani Gauges
- Spark Plug Electrodes
- Wollaston Wire
- Duro Palladium

BASE METALS · RARE METALS  
PRECIOUS METALS and ALLOYS

- Galvanometer Suspension Strips
- Platinum-Covered Grid Wire
- Gold Covered Silver Wire
- Gold Cyanide for Plating
- Special Melts and Alloys
- Gold Covered Grid Wire
- Small Spring Ribbon
- Electroplated Wires
- Ribbon, All Metals
- Molybdenum Ribbon
- Tungsten Ribbon
- Filament Ribbon
- Filament Wire
- Fuse Wire
- Grid Wire

Write for List of Products and Data

## SIGMUND COHN & CO.



44 GOLD STREET NEW YORK 7



# Haydon

\* *Electroneered Timing*

AS DEVELOPED FROM THE . . .



## SYNCHRONOUS TIMING MOTOR

by Haydon

Springing from a long line of timing motors, by Haydon engineers, now Haydon Electroneered Timing serves a thousand industries with more than a million Haydon Synchronous motors of many types—hundreds of them custom-made for specific and critical applications.

Plan for automatic timing in your products. Synchronous AC timing motors, by Haydon, are available with torque output of 5 to 20 inch ounces, basis 1 RPM; specially protected, where necessary, for salt spray, tropical service, vibration . . . lubricated to ambient temperature specifications of the customer; special coils and leads available for high temperatures; available in a wide range of voltages, frequencies, and output shaft speeds. Compact — light in weight — rugged and reliable.

DC Motors also available for DC Applications.

A copy of the latest Haydon catalogue available on your request.



\*ELECTRONEERED TIMING

# Haydon

MANUFACTURING COMPANY  
\* INCORPORATED \*

Forestville, Connecticut

ANOTHER SPECIAL BY PROGRESSIVE

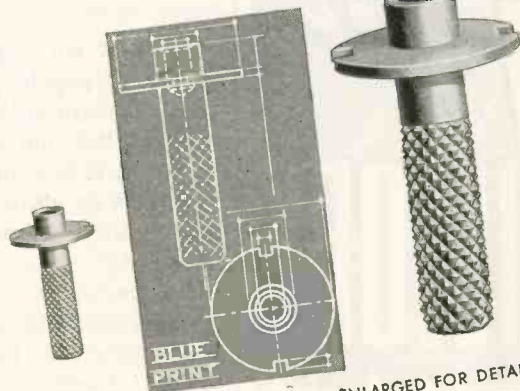

ACTUAL SIZE

ENLARGED FOR DETAIL

**CATALOG SHOWS DOZENS MORE**  
Special heads, threads and finishes on any metal or alloy adapted to cold upset. Weekly output: 25,000,000 pieces. Many specials, suggesting production savings for you, illustrated in latest catalog. Includes weights per 1M standard pieces, dec. equivs. of fractions, other purchasing and engineering helps. Write for Catalog 18.

*The* **PROGRESSIVE MFG. CO.**  
50 NORWOOD ST., TORRINGTON, CONN.

★ BONUS BUY MORE WAR BONDS ★

A Name to Look for on Electrical COILS and Transformers

# GRACOIL

"One Good Turn — or a Million"

Famous for years as COILS by DOYLE



LAYER-WOUND COIL



RELAY COIL

Be sure that the coil you buy bears the trademark name — "GRACOIL", for only then can you know that you have the best in electro-magnetic windings. Every "GRACOIL" is wound to the specified number of uniform turns from precision-gauged wire. Every "GRACOIL" is fully insulated, thoroughly impregnated, and properly laminated when supplied as a complete transformer. The most rigid inspections and tests make sure that each "GRACOIL" is worthy of the name it bears.

If your design calls for a special electro-magnetic application, let competent "GRACOIL" engineers make specific recommendations for you. Write today!



LOW VOLTAGE TRANSFORMER



GENERATOR FIELD COIL

## THE GRAMER COMPANY

*Electrical Coils and Transformers*

2736 N. PULASKI RD., CHICAGO 39, ILL., U. S. A.

**VICTORY**  
*and Beyond*

You can count on Wincharger Antenna Towers. They combine strong efficient coverage with built to last qualities that insure you years of service.

Add to these advantages their strikingly attractive appearance plus a sensationally low initial cost and it's easy to see why an ever increasing number of Wincharger Antenna Towers are being used for:

**Commercial Broadcasting  
Police Work  
Signal Corps Air Lines  
Ordnance Plants**

To be sure for years ahead  
—be sure to specify Wincharger Antenna Towers.

Makers of  
**WINCHARGER**  
FARM ELECTRIC  
SYSTEMS  
**WINCO**  
DYNAMOTORS  
**WINCHARGER**  
VERTICAL  
RADIATORS

**WINCHARGER VERTICAL RADIATOR**  
WINCHARGER CORPORATION      SIOUX CITY, IOWA

## NEW BOOKS

### The Soul of Amber

By ALFRED M. STILL. Published by Murray Hill Books, Inc., 232 Madison Ave., New York, N. Y., 1944. 274 pages, \$2.50.

THIS BOOK WILL NEVER achieve the heights of popularity held forth by the publishers in the jacket because it is definitely not a "popular" book. However, it is a contribution to the literature on electrical science that could easily become of major importance.

It is a review of practically all of the great, and most of the near-great, names in the history of electricity, including what they contributed to electrical science and what they thought. As such it is of definite value to anyone interested in the background of electricity and electronics. The author has performed a monumental piece of work. He has read, digested and evaluated an incredible amount of literature that deals with the personalities behind electrical engineering down through the ages.

The name of the book is inaccurate, in a sense, because the soul of amber is electricity or an electrical charge. Amber as such is discussed only briefly. It would seem that the title was chosen for popular appeal when the text does not live up to that appeal. Actually, this book would make dull reading for anyone not interested in electricity and the development of this "art" as we know it today.

There are some errors of omission that seem to be serious, whether or not they are intentional. Nothing is said about the contributions of Edison and Tesla. Steinmetz is covered only briefly. Westinghouse and William Stanley are given all the credit for developing alternating current to the point where it was practical, even though Westinghouse paid Tesla \$1,000,000 for his patents. None of the living electrical scientists are mentioned at all. Conversely, what seems like an inordinate amount of space is devoted to Faraday, Eddington and others who although they are important seem to have been emphasized too much.

Two indices are provided—one of names and the other of subjects. Both could be considerably ex-

*for* **BATTLE or**  
**COMPETITION**

You can always depend on Winco Rotary Electrical Equipment to do its job in a way that will help build and maintain your record for outstanding service and dependability. Our engineers are at your service. Consult them when you need—

- ★ Built-in and Shell Type Motors
- ★ Adjustable Speed Motors
- ★ Synchronous Motors
- ★ Rotary Electrical Equipment for Aviation
- ★ Dynamotors and Inverters
- ★ Motor Generator Sets
- ★ Railroad Car Lighting Generators

**WINCO ROTARY**  
**ELECTRICAL EQUIPMENT**  
WINCHARGER CORPORATION      SIOUX CITY, IOWA

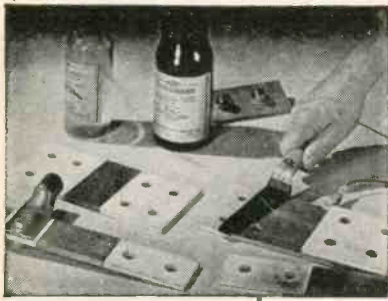

**RAPID**

## METAL-COATING PROCESS

- FAST AND ECONOMICAL
- FOR HEAVIER COATINGS

REQUIRES ONLY RAPID ELECTROLYTE—RAPID METAL CLEANER—RAPID APPLICATOR

- Plating current is obtained from dry cells, storage battery, or any convenient source of direct current at 3 to 6 V., or use Rapid Plating Rectifier for heavy work.
- For silver surfacing bus bar connections, lugs, switch blades, etc. For plating or touching up miscellaneous surfaces with cadmium, nickel, zinc, copper and gold. Building up limited areas. Hard surfacing with nickel. Used in shop or field. Special applicators designed to speed up production line jobs.

Our laboratory is glad to cooperate.  
No obligation

**Rapid Electroplating Process, Inc.**

1414 S. Wabash Ave., Chicago 5, Ill.  
621 Graybar Bldg. 237 Rialto Bldg.  
New York, N. Y. San Francisco, Calif.

## WANTED INSTRUMENT DESIGNER

A medium-sized industrial organization offers an excellent opportunity to a man with the necessary qualifications. Position will pay top salary. Present and post-war possibilities are unusually attractive.

The man we seek must hold an Electrical or Mechanical Engineering Degree, and have a knowledge of optics or electronics. He should also have at least four years practical experience in instrument design.

Please write in detail. Your reply will be held in strict confidence.—WMC regulations observed. Our personnel knows of this adv. Write

P-852, Electronics  
330 W. 42nd St., New York City 18, N. Y.



Listen, Jim!  
**ASSOCIATED RESEARCH**  
NOT ONLY MAKES  
**VIBROTESTS**

for insulation resistance testing but also VIBROGROUND for ground testing, HYPOT for high voltage breakdown testing, DONUT transformers, SHUNTS, RESISTORS, and many other products.

WHERE CAN  
I GET ...



VIBROTEST is an outstanding name for easy simplified and accurate insulation resistance testing. Compact, portable, operated in any position, it is in wide use in electrical power fields, industry and all electrical departments. But it is only one of the many products of Associated Research.

### BRING YOUR SPECIAL PROBLEMS TO US

The experience of our technicians is at your disposal, with complete facilities for designing, developing and manufacturing to your requirements. We serve organizations and individuals. We produce in large and small quantities. We are equipped for prompt delivery.

Engineering Service Representation in all Principal Cities  
WIRE OR WRITE FOR IMMEDIATE ATTENTION

*No Cranking  
No Leveling*

Self-contained power source. Easily read scale shows ohms and megohms. Vibrotest Model 201 illustrated. Range 0-200 megohms at 500 V. potential, 0-2,000 ohms, 150-300-600 volts AC or D.C. Send for Bulletins on all models.

**ASSOCIATED RESEARCH, Inc.**



223 So. Green Street  
Chicago 7, Illinois

• INSTRUMENT HOUSINGS

• PANELS

• CHASSIS

• METAL AND PLASTIC SPECIALTIES

**SCREW MACHINE PARTS AND STAMPINGS**  
*Manufactured to your Requirements*

Experienced fabrication and dependable service for all types of radio and electronic parts. Send us your drawings and specifications for quotation.

**STAMFORD METAL SPECIALTY CO., 428 BROADWAY, N. Y. 13**

*Metal Work of Every Description*



## SAFETY DOOR INTERLOCK SWITCH

An inexpensive, dependable safety device that breaks power circuits when access doors are opened. Protects personnel, guards equipment. Particularly suitable for radio transmitters, television receivers, X-ray and therapeutic machines, fire doors and burglar alarms. For details write: Electronics Department, General Electric, Schenectady 5, New York.

**GENERAL ELECTRIC**  
164-D3





## WALDEN WORCESTER WRENCH SETS

Engineered for Strength and to fit the mechanics need. Thousands of these sets have been sold here and abroad.

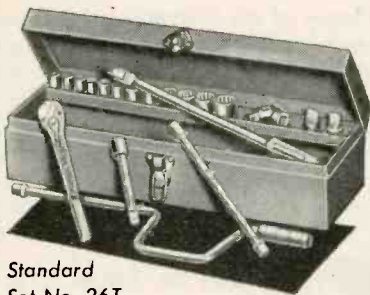

Standard  
Set No. 26T

The Mechanics Favorite. Wide range of Sockets, Special Handles, Reversible Ratchet Wrench. 22 pieces in a Steel Box.



Set No. 16T

A very handy set of 17 pieces in a Steel Box.

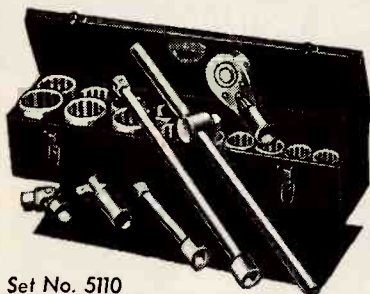

Set No. 5110

Wide range of Sockets, Special Handle, Reversible Ratchet Wrench. 21 pieces in a Steel Box.

Send for Catalog No. 141 picturing a full line of Automobile, Aircraft and Radio Tools.

**WALDEN  
WORCESTER  
WRENCHES**

**STEVENS WALDEN, INC.**

468 SHREWSBURY STREET

WORCESTER, MASSACHUSETTS

panded to make the book of greater value to those who want more detail. There is also a too-short chronological table of key dates in the progress of electrical science. Just in passing, it would be interesting to know why the dates for the first steam locomotive and Fulton's steamboat are included in this table.—K.S.P.

• • •

## Plastics in Practice

By JOHN SASSO and MICHAEL A. BROWN, JR. Published by McGraw-Hill Book Co., 330 West 42nd Street, New York 18, N. Y., 1945 185 pages, \$4.00

MORE THAN one-half the total poundage of molded and laminated plastics goes into parts and assemblies associated with electrical circuits. Because electronics is a relatively new science, it is only natural that a good portion of this poundage should be found in electronic applications. In effect a handbook of plastic applications, this book offers much of interest to electronic engineers, especially if they are concerned with the development, design or production of components of electronic equipment.

The book consists of a collection of successful case histories of designs of over 100 plastic parts of all kinds. Each application described is covered from all standpoints. In fact, the treatment is such that the specific application is merely a peg on which to hang a discussion of the whys and wherefores of applications of plastics in various fields or for various purposes. In this respect the book is unique in industrial publishing.

Many of the case histories are of direct interest to the electronics field, particularly in view of their background discussions. These include circuit-breaker handle, cold-molded heater plug, standoff insulator, radio cabinets, electrical controller, radio-tube base, fence-control housing, microswitch, cable insulation, molded capacitor, ignition distributor head, name plates, non-metallic gears, double injection molding, coaxial cable, heat-resistant styrene thermoplastic, styrene elastomer, thermosetting copolymer and silicone resins.

An introduction describes briefly

NUMBER TWO OF A SERIES

IN 100-HOUR  
SALT SPRAY TEST

DC  
means  
SC

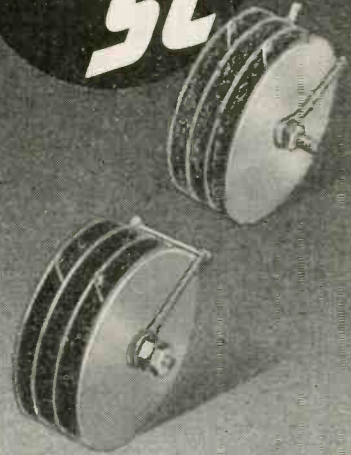

DC means SC . . .

Selenium Conversion and Selenium Control. SC Type "K" Selenium Rectifier is especially designed to pass the 100-hour salt spray test at 50° Centigrade. Again proving that DC means SC...Selenium Conversion and Selenium Control. If you use DC . . . get the facts on SC.

**SEND FOR  
BULLETIN**

**SELENIUM CORPORATION  
of AMERICA**



1719 WEST PICO BOULEVARD  
LOS ANGELES 15, CALIFORNIA

EXPORT DIVISION: FRAZER & HANSEN  
701 CLAY STREET, SAN FRANCISCO, CALIFORNIA

IN CANADA: BURELCO LTD., TORONTO 13, ONTARIO, CANADA

**RADIO  
TEST ENGINEERS  
TECHNICIANS  
REPAIRMEN**

**New York Location**

**For Interview  
Apply or Write**

**Hudson American Corp.**  
36 West 47th Street  
5th Floor  
New York, New York

**JONES SHIELDED TYPE  
PLUGS and SOCKETS**



P-101-1/4"



S-101

Low loss Plugs and Sockets suitable for high frequency circuits. Ideal for antenna connections, photo-cell work, microphone connections, etc. Supplied in 1 and 2 contact types. The single contact type can be furnished with 1/4", .290", 5/16", 3/8", or 1/2" ferrule for cable entrance.

Knurled nut securely fastens units together. All metal parts are of

brass suitably plated to meet Navy specifications. No. 101 Series Plugs have ceramic insulation and Sockets have XXX Bakelite. For complete listing and information write today for your copy of catalog No. 14.

**HOWARD B. JONES COMPANY**  
2460 W. GEORGE ST. CHICAGO 18

**AUTOFLIGHT HIGH SENSITIVITY RESISTORS**  
For Instruments : Recording Systems

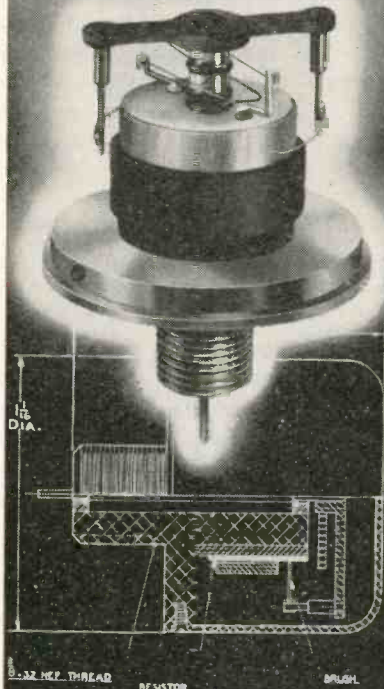

AUTOFLIGHT High Sensitivity Resistors, the first of their kind ever built in the United States, have been designed to produce from a low torque rotational movement a variable electric resistance. These resistors can be connected directly to sensitive low torque apparatus such as aircraft Flight Test recording instruments, and will operate relays or recording systems without the use of amplifiers, and from a simple D. C. source. They are particularly useful in laboratory or industrial applications where photo-electric cell and amplifiers were heretofore required.

Obtainable in various types from 100 to 1500 ohms, and from 4 to 15 watts, AUTOFLIGHT resistors require but 2 gram millimeters input torque to overcome friction. This low value is secured by use of a jewel supported shaft, the contact mechanism being made with the accuracy of a fine watch. The accuracy of AUTOFLIGHT High Sensitivity Resistors makes them an outstanding product in their line.

AUTOFLIGHT'S engineers and technical advisors will gladly cooperate with you on specific problems embodying High Sensitivity Resistors. Write G. M. Giannini & Company, Inc., 161 E. California Street, Pasadena, Calif., U. S. A.



**PERMANENT MAGNETS**

All Shapes—All Sizes—for All Purposes  
**COBALT—CHROME—TUNGSTEN**

*Stamped, formed and cast*

**Alnico** (*Cast or Sintered*)  
*under G. E. License*

Also: Laminations for Radio Transformers  
**TOOLS—DIES—STAMPINGS**

*Heat Treating of Metals and Alloys*

**THOMAS & SKINNER STEEL PRODUCTS COMPANY**  
1116 EAST 23RD STREET • INDIANAPOLIS 5, INDIANA

**NORCO** SPECIAL PURPOSE  
Electronic and Mechanical

**TEST EQUIPMENT**



For aircraft electrical and mechanical instruments . . . aircraft controls, radar, meteorological stations, and similar devices. Built to specifications and designs. Inquiry invited.

**NORTHERN COMMUNICATIONS MANUFACTURING CO.**  
210 EAST 40th STREET NEW YORK 16, N. Y.  
*Manufacturers of Transformers • Special Coils • Reactors • Sound Systems  
Recorders • Equalizers • Full Range Phonograph • Coaxial Transmission Lines*

# STOP VIBRATION GREMLINS WITH BIRTCHER STAINLESS STEEL - LOCKING TYPE TUBE CLAMPS



Where vibration is a problem, Birtcher Locking TUBE CLAMPS offer a foolproof, practical solution. For ALL types of tubes and similar plug-in components.

**83 VARIATIONS**

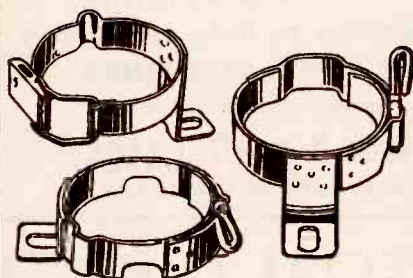

OVER TWO MILLION IN USE  
Send for our standard catalog and samples of corrosion-proof Birtcher Tube Clamps.



**THE BIRTCHER CORPORATION**  
Manufacturers of AIRCRAFT  
and RADIO PARTS  
5087 HUNTINGTON DR. LOS ANGELES 32

the various plastic materials, methods of forming, comparative properties, important design considerations and cost factors. Both of the authors have given plastics a good part of their attention for many years and are well-known in this field. The book reflects their wide interests and activities. It should be a valuable aid to any engineer who is interested in plastics.—K.S.P.

## Production-Line Technique

By RICHARD MUTHER. McGraw-Hill Book Co., 330 W. 42nd St., New York 18, N. Y., 1944, 320 pages, \$3.50.

THE NECESSITY FOR turning out large quantities of precision equipment at a fast rate for the armed services forced many companies to turn to line production from job-lot manufacture. The success of this change has been apparent for some time, although at the start it was doubtful whether or not many types of equipment could be produced in this way.

There are certain fundamentals common to all production-line methods. If these fundamentals are thoroughly understood there should be little difficulty in applying such methods wherever they can economically be used. This book, then, was written expressly for industrial executives who are considering the use of line production. It pictures the current state of this art as found in well-established organizations after a two-year study to gain first-hand information. In particular, the book was written for medium-sized plants, which have always been the accepted domain of job-lot manufacture.

Four general sections are provided—advantages and limitations of line production, establishing the line, operating the line and diversification in line production. A chapter of problems is included to help the reader become familiar with production-line techniques.

Manufacturers of electronic equipment all the way from simple parts to complicated assemblies could make good use of this book by studying it to determine whether or not their products are applicable to line production. The final answer may not always be readily apparent, but if the book stimulates thinking along the proper lines it will have served its purpose.—K.S.P.

# 2 VITAL AIDS

TO THE MANUFACTURER OF  
*Miniature Tube Radios*

## ★ STAR

DOUBLE-CHECK SYSTEM



#JE-10—Miniature socket wiring plug for accurate alignment of miniature socket contacts during wiring. Precision cast of zinc base alloy—Pins of stainless steel.

#JE-12 — (Hardened tool steel insert) or JE-13 (Stainless steel insert) Miniature tube pin straightener to obtain a perfect fit when the tube is placed in the set.



For complete information and prices—write

RADIO ACCESSORY DIVISION

**STAR EXPANSION PRODUCTS CO.**  
147 Cedar St., New York 6, N. Y.

## To Serve You Better

AN ALTERNATE SOURCE  
OF GENUINE BIRTCHER  
TUBE CLAMPS

## Prompt Delivery

We are fully licensed to manufacture the complete BIRTCHER line of locking type, stainless steel tube clamps. Orders placed with us for prompt delivery using BIRTCHER part and identification numbers will be filled at prices as favorable as those to which you are accustomed. All clamps will be identical with those manufactured by the Birtcher Corporation.

SOLE LICENSED MANUFACTURER  
OF BIRTCHER TUBE CLAMPS

**THE GEORGE S. THOMPSON  
CORPORATION**

5240 HUNTINGTON DR.  
LOS ANGELES 32, CALIF.

# Capacitors

of Time-Tested Quality

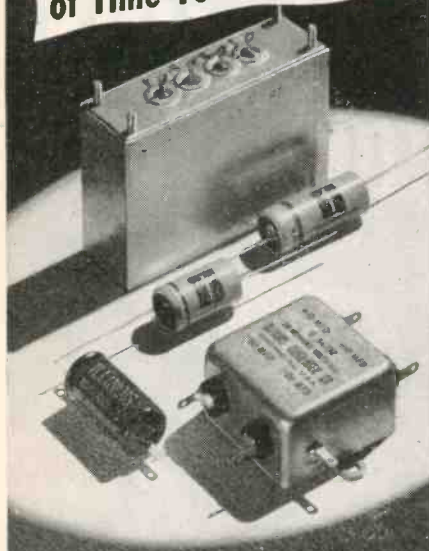

## Illinois CONDENSER COMPANY

1160 N. HOWE ST. • CHICAGO 10, ILL.  
Manufacturers of Oil, Paper and Electrolytic Capacitors

## ENGINEERS FOR DESIGN WORK ON RADIO RECEIVERS, AUDIO AMPLIFIERS, TELEVISION

Men with substantial experience wanted, preferably those having Degrees in Electrical or Communications Engineering. Write, giving details of experience and salary expected, to:

### FREED RADIO CORPORATION

Makers of the Famous Freed-Eisemann Radio-Phonograph

200 Hudson Street  
NEW YORK 13, N. Y.

## TO MEET ELECTRONIC REQUIREMENTS

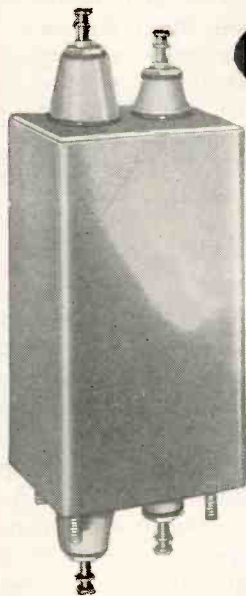

We are completely equipped for volume production. Write us concerning your requirements.

### DONGAN ELECTRIC MFG. CO.

2977 Franklin

Detroit 7, Mich.

**DONGAN**  
TRANSFORMERS

The Dongan Line  
Since Nineteen-Nine

We Invite  
Inquiries

*Precision engineered for electronic requirements*

## QUADRIGA Quality WASHERS

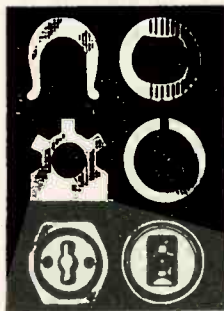

Special, Flat, Tension and Spring, Formed and Drawn, Cupped and Finishing, Wire Terminals, etc. Any quantity. Prompt delivery. Also SMALL STAMPINGS, any design. Send specifications for quotations.

Ask for **Quadriga Catalog**

Photos show samples of Quadriga superiority. Tables, data, valuable information. Wire or write.

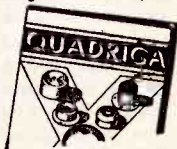

### THE QUADRIGA MANUFACTURING CO.

Incorporated 1894.

221A West Grand Ave., Chicago 10, Ill.

"Half a century"

Test Insulation the Modern Way  
with a MODEL B-5

## MEGOHMER

### NEW BATTERY-VIBRATOR TYPE

No more tiresome cranking of a hand-driven generator . . . Entirely self-contained, steady test potential of 500 volts DC, available at the touch of a switch. Direct reading in insulation resistance.



**HERMAN H. STICHT CO., INC.**  
27 PARK PLACE NEW YORK, N. Y.

WRITE FOR BULLETIN No. 430E

# design counts



Remember the old flatiron? It did its job, of course; but just compare it with the modern electric iron which has been brought to its present high level of utility by careful application of design.

Here at THE WARD PRODUCTS CORPORATION, design is one of the most carefully considered factors in the manufacture of antennas. It is only through superior design that durability, styling and the benefits of superior production can be best brought to the user. For the finest antennas for all applications — for home and automobile use — look to WARD.

Back Again . . . Soon  
WARD Aerials  
"World's Finest for Car and Home"

# WARD

## Antennas

BUY WAR BONDS  
THE WARD PRODUCTS CORPORATION  
3523 EAST 45TH STREET • CLEVELAND, OHIO

## Backtalk

This department is operated as an open forum where our readers may discuss problems of the electronics industry or comment upon articles which **ELECTRONICS** has published.

### Dangerous Art

Dear Mr. Henney:

I READ **ELECTRONICS** pretty carefully, including the advertisements which are a great source of information. Two recent full-page advertisements by commercial organizations have set me thinking about safety. We are all safety conscious, and I am especially so since our laboratories here necessarily must be as safe as possible. Of course, some risk is inevitable.

But to get on: In one ad, the caption reads that the specialist is giving a capacitor a thorough "... voltage and capacitance checking." With his right hand the operator practically touches the hot side of a transmitting capacitor presumably being tested at several thousand volts; with the left hand he applies the power to the circuit! A perfect arrangement for a serious accident.

The photograph of the testing of a vacuum capacitor in another issue is a second case in point. From the sphere-gap it is evident that the capacitor is being tested at a rather high voltage; one hand of the operator is on the hot circuit and the other on the power switch.

I feel that these examples of unsafe testing methods represent a low order of engineering and should not be given the widespread publicity which their publication in **ELECTRONICS** will ensure.

P. M. HONNELL

Lieut. Colonel, S.C.  
O-I-O of Laboratories  
Dept. of Chemistry and Electricity  
United States Military Academy  
West Point, N. Y.

### About the Format

Dear Sirs:

ON RECEIVING my November 1944 issue of your publication I was astonished and delighted to find that you had led the way back to common sense in the arrangement of your articles so that one could read the whole article without the irri-

# POWER STAMINA LONG-LIFE

SM Fractional H.P. Motors  
for dependable performance



With a SM motor, you get a unit designed for a specific job, engineered to your exact performance requirements, precision-built to

your specifications, produced in volume for your needs. SM fractional H.P. motors are made to order with speeds from 3,500 to 20,000 R.P.M. — 1/10th to 1/200th H.P. — voltage from 6 to 220 AC-DC. Illustrated is the famous SM-2 Blower Motor; many thousands have been made for military purposes. Other SM motors have been designed and produced in large volume for a wide variety of radio, aircraft and other applications where rugged power, stamina, long life and dependable performance were primary requisites. What are your requirements?

Small Motors, Inc.  
1308 ELSTON AVE., CHICAGO 22, ILLINOIS

DEPT. 50

Manufacturers of special small universal, fractional H.P. motors, dynamotors, shaded pole motors, heater motors, generators.

Design • Engineering • Production



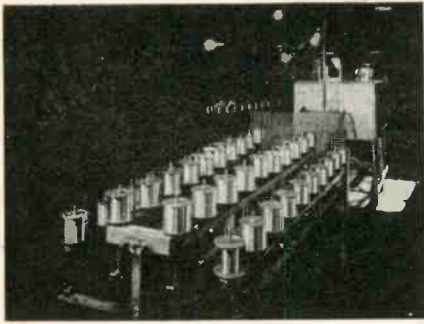

## RESISTANCE WIRE

### ALLOYS FOR EVERY PURPOSE

**ALLOY "A"**—Nickel-chromium; non-magnetic; spec. resistance 650 ohms/CMF.

**ALLOY "C"**—High resistance to oxidation and corrosion; for electronics and industrial equipment.

**ALLOY "D"**—Nominally 30% nickel, 15% chromium, balance iron. Specific resistance 600 ohms/CMF.

**ALLOY "45"**—Copper-nickel for winding precision resistors. Constant resistance over wide range of temperatures.

**KANTHAI**—Unavailable for duration; we will be pleased to supply data for your post-war requirements.

The **C. O. JELLIFF MFG. CORP.**  
123 Pequot Rd. Southport, Conn.

*Memo to*  
the New England  
Electronic Market

Representing the country's leading old-line manufacturers in the New England states, we offer a wide range of components for jobber sales and for incorporation in assembled products:

controls — resistors — condensers — coils — chassis — transformers — sockets — relays — meters — solder — microphones — jacks — cements — etc. (This is only a partial list).

Your current and post-war plans can be served properly with the full co-operation of our manufacturers and our own experienced staff, a member of which will be glad to meet with you at your convenience.

### HENRY P. SEGEL COMPANY

Radio—Electronic—Electrical  
Manufacturers' Representatives  
Field Engineers

143 NEWBURY STREET  
BOSTON 16, MASS.

Tels. KENmore 3012—6333—9755  
In Hartford: Tel. 2-9859

21 years of serving manufacturers, jobbers, schools and laboratories in New England.

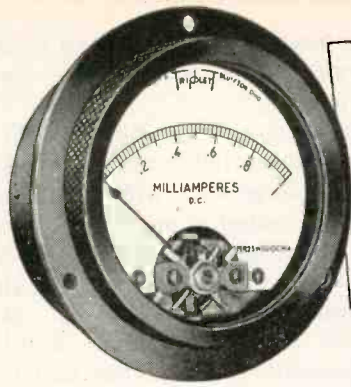

Introducing the  
**NEW TRIPLET LINE**  
of  
HERMETICALLY SEALED INSTRUMENTS

All the features of standard instruments retained. Withstand submersion tests at 30 feet. Comply with thermal shock, pressure and vibration tests. Resistant to corrosion. Conform to S.C. No. 71-3159 and A.W.S. C-39.2-1944 specifications. 1½", 2¼" and 3½" metal cases with 1/16" thick walls, in standard ranges. D.C. moving coil, A.C. moving iron and thermocouple types. Write for circular.

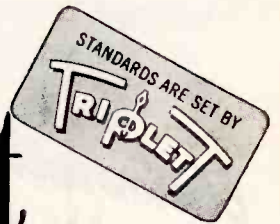
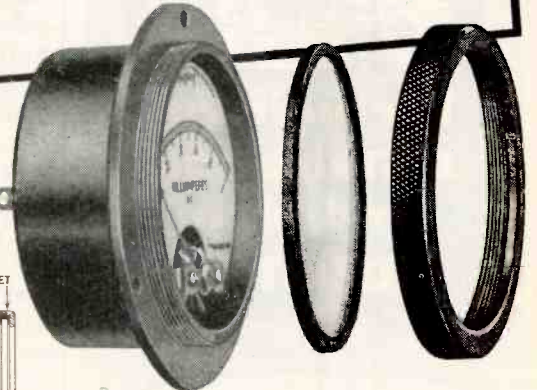
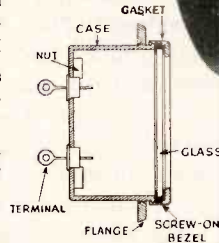

# Triplet

**ELECTRICAL INSTRUMENT CO.** BLUFFTON, OHIO

ARGON · NEON  
HELIUM · KRYPTON  
XENON

## GASES

### HYDROGEN NITROGEN · OXYGEN

COMPLETE FORMING MIXTURES  
GAS PRODUCTION CARBON DIOXIDE  
PLANTS INSTALLED ACETYLENE  
FOR LOWEST COST  
OPERATION . . . HIGHEST QUALITIES · ANY QUANTITY  
DELIVERED ANYWHERE

## AMERICAN GAS & CHEMICAL CO.

HARRISON, NEW JERSEY · Contracted Complete Service on All Gases

SP&R-1



**CUP WASHERS**  
for Binding Screws

*Preferred*  
as a source of precision-made  
**WASHERS** and  
**STAMPINGS**  
manufactured to  
your specifications.



**WHITEHEAD STAMPING CO.**  
1691 W. Lafayette Blvd. Detroit 16, Michigan



**For uniform  
DISTRIBUTION  
and high  
FIDELITY...**

*University*

**RADIAL CONE  
SPEAKER  
PROJECTORS**

The Model RBP 12 illustrated and the similar, but smaller RBP 8 are expressly designed for the high quality reproduction of music. Their exclusive infinite baffle design provides excellent low frequency response. All tendency towards mechanical resonance or rattle is eliminated through skillful engineering and rubber rim damping. Uniform sound dispersion is attained through radius of 360°, without concentration of sound directly beneath the speaker.

UNIVERSITY radial cone projectors are pleasing in appearance, compact and completely "water-shedding". Continuous outdoor exposure is permissible. RBP 12 and RBP 8 are ideal for all indoor and outdoor installations where the advantages of a centralized sound source are desired.

Write today for complete information on this all-inclusive line of speaker and driver units.



**UNIVERSITY  
LABORATORIES**  
225 VARICK STREET  
NEW YORK 14, N. Y.

tating need to chase the tail ends through endless hide-outs in the back pages.

The fashion of insulting the authors of the articles and the readers thereof is very widespread in American technical and trade journals and causes constant irritation to those who are interested enough to pursue the elusive "rest of the article." Apart from this it is also self-derogatory, as if the editors said actually "This is the only part worth reading; if you *must* read the rest, sort it out for your self—it's somewhere in the back of the number." Then begins the school-boy prank "Turn to page 163" etc., etc. *ad nauseum*.

You have shown now that the articles *can* be arranged in intelligent consecutive fashion, at the expense of a little thought (and possibly some sub-editing) and I am sure the majority of your readers will appreciate the compliment as much as I do.

For those of us who endeavor to maintain files of reference for particular subjects, the added simplicity saves a lot of cross referencing between files to indicate the whereabouts of a page containing the tag-ends of two or more articles on separate subjects. In some cases this involves typing the rest of an article to complete the file record.

I offer my sincere thanks for the saving of time and patience, and the added pleasure of reading the subject matter.

V. HARDING

Wing Commander  
Technical Branch  
Royal Australian Air Force

**Cathode Followers**

Dear Mr. Skeeters:

ACCORDING TO your last letter, (ELECTRONICS, May 1945) I see that you are misinterpreting the end results of my article in the October 1944 issue, entitled Cathode Follower Calculations.

If you will study the article carefully you will notice that there are two impedances mentioned; one is the output impedance,  $Z_{out}$ , equations 8 and 9, and the other is the internal impedance of the cathode follower,  $Z_c$ , equations 10 and 11. The former is the parallel combination of  $R_2$  (the cathode resistor) and  $Z_c$  (the internal impedance).

Therefore, as you can see, the

**PROFESSIONAL  
SERVICES**

Research            Production  
Design              Management  
Development       Sales  
Publications

**ASSOCIATED ELECTRONICS  
CORPORATION** CONSULTING ENGINEERS

Complete Engineering Service for all Industries  
RESEARCH            MANAGEMENT  
DEVELOPMENT       PRODUCTION  
DESIGN                PUBLICATIONS  
132 Nassau Street,       New York, 7, N. Y.  
251 Kearney Street,     San Francisco, 8, Cal.

**STANLEY D. EILENBERGER**

Consulting Engineer  
INDUSTRIAL ELECTRONICS  
Design—Development—Models  
Complete Laboratory and Shop Facilities  
6309-13—27th Ave.  
Kenosha, Wis.            Telephone 2-4213

**ELECTRONIC ENGINEERS**

Designers and Consultants  
Design for Manufacture—Radio and Electronic products designed to your specifications.  
Engineering models        Production drawings  
Consulting—Radio and Electronic Problems  
Complete Development and Research Laboratories  
Branch Office Near Chicago  
611 E. Garfield Ave.        Glendale, California

**DON FOSTER**

Engineering Consultant  
Electrical            Specialist in        Mechanical  
Analysis            Sound and Electronics    Development  
30 Burns Ave., Wyoming 15, Ohio

**PAUL E. GERST & CO.**

CONSULTING ENGINEERS  
Specialists in  
Electrical Product Design  
El. Machinery, Apparatus & Applications  
El. Appliances, Hi-Frequency Apparatus  
Electronics, Radio Communication.  
205 W. Wacker Dr.        Chicago 6, Ill.

**HODGSON & ASSOCIATES**

Physics, Mathematics, Research, Development & Patent Consultants.  
Satisfaction guaranteed. Submit your problem for a preliminary survey without cost.  
Box 874                      Sherman Oaks, California

**JOSEPH RAZEK, Ph.D.**

Consulting Physicist  
Electrical and Mechanical Engineering Problems  
Instruments and Control Devices        Electronics  
Specialists in Colorimetry, Spectrophotometry and  
Industrial Color Control  
Laboratory and Shop Facilities  
202 Darby Road            Phone Hilltop 6910        Lanerch, Pa.

**READER MAY CONTACT**

the consultants whose cards appear on this page with the confidence justified by the offering of these special services NATIONALLY.

# ENGINEERS WANTED

Here's an opportunity to join one of America's largest manufacturers of electronic and communications equipment.

**Radio**  
 • **Electrical**  
**Electronic**  
**Industrial**  
(Job evaluation)  
 • **Mechanical**  
 • **Factory Planning**  
**Materials Handling**  
**Manufacturing Planning**

Work in connection with the manufacture of a wide variety of new and advanced types of communications equipment and special electronic products.

Write giving full qualifications, or apply to:

R. L. D., EMPLOYMENT DEPT.

**Western Electric Co.**

100 CENTRAL AV. KEARNY, N. J.  
 • Also: C. A. L.  
 Locust St. Haverhill, Mass.  
 Applicants must comply with WMC regulations

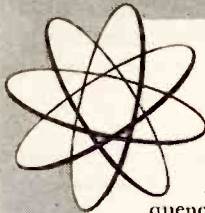

## REGULATED POWER SUPPLY

250-450 VOLTS

Wide fields of application have been opened up both in research and industry for this unit. A-C ripple is negligible and extreme care has been taken to eliminate high-frequency noise. Regulated power supply units are invaluable for such applications as amplifiers, television pulse generators, constant frequency oscillators, and measuring equipment.

Other G-E regulated power-supplies are available in the following ranges: 180-300 volts 160-1500 volts Dual Regulated

Write today: Electronics Department, Specialty Division, General Electric, Syracuse, N. Y.

**GENERAL ELECTRIC**

Electronic Measuring Instruments

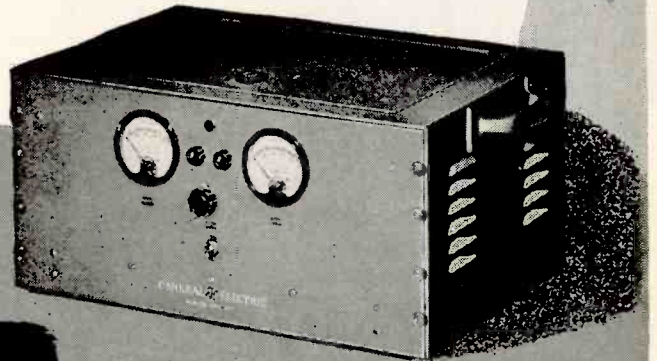

**PS-1**

## RADIO CHASSIS PUNCH



Saves hours of work cutting clean, accurate holes in radio chassis—for connectors and other receptacles. Simply insert cap screw in hole to be enlarged (drill small hole if necessary), turn with ordinary wrench to force punch through the metal. No reaming or filing—hole is smooth and clean. No distortion—die supports metal. Ten sizes from 3/4" to 2 1/4"; also up to 3 1/2" for meters. Write for free catalog 33E to Greenlee Tool Co., 1927 Columbia Ave., Rockford, Ill.

*Get Ready with Greenlee!*  
 REGISTERED TOOLS  
**GREENLEE**  
 FOR THE CRAFTSMAN

★ ★ ★  
*Electroneering*

... is the RAULAND word for the finest in electronics from research through engineering to the finished product.

THE RAULAND CORPORATION  
 CHICAGO 41, ILLINOIS

**Rauland**  
 RADIO...RADAR...SOUND  
 COMMUNICATIONS...TELEVISION

*For Radio at its Best*

Again, when the war is won, we will be on call

.. To DESIGN, DEVELOP and MANUFACTURE ..

Radio Receivers and Transmitters  
 Industrial Electronic Equipment  
 Airport Radio Control Equipment  
 Marine Radio Telephone Equipment

Your inquiries will receive immediate action

**ISLIP RADIO MFG. CORPORATION**  
 ISLIP, L. I., NEW YORK



## NOZZLE TESTER Keeps Diesel Engines Running Efficiently

To keep diesel engines operating at peak efficiency, this portable, precision-built Adeco Nozzle Tester is indispensable.

Light in weight yet built for heavy-duty service, it enables any mechanic to make quick accurate tests on injector opening pressure, spray pattern, etc., and detect stuck needle valves and leakage around valve seats. Tests both large and small injectors, on bench or engine, at pressures up to 10,000 p. s. i. Prevents costly delays and possible damage to engine.

Ideal for testing hydraulic devices.

Write for bulletin on this practical, low-cost unit.



TESTS FUEL INJECTORS  
AND HYDRAULIC DE-  
VICES at Pressures up  
to 10,000 p.s.i.



AIRCRAFT & DIESEL  
EQUIPMENT CORP.

DEPT. 16: 4411 N. RAVENSWOOD AVE.  
CHICAGO 40, ILLINOIS

effect of the cathode resistor is not neglected in the solution for the output impedance, and the only assumption made is that  $\mu$  is very much larger than 1.

HUMBERT P. PACINI  
Wanamassa, N. J.

• • •

### Accentuate the Positive

Dear Sirs:

THERE IS AN ERROR in Fig. 5 on page 143 of the May 1945 issue. The large circle represents *maximum* voltage across  $C_2$  instead of *minimum* voltage across  $C_2$ . Although this is rather obvious from the text, I thought you would like it called to your attention.

W. B. BRUENE  
Collins Radio Co.  
Cedar Rapids, Iowa

• • •



Interim report shows status of Bell Telephone coaxialization program in map above where heavy solid line represents cable installed or in process up to the end of 1945, dotted line shows remainder of 5-year program and fine solid line marks existing major toll lines of the system. The end of 1945 is expected to see 2000 miles of the cable (as shown below in full flower) manufactured, and at least 75 percent of it in the ground

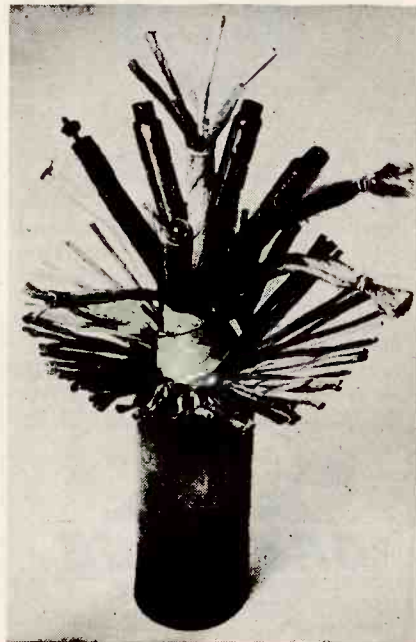

## SEARCHLIGHT SECTION

### POSITIONS VACANT

**ELECTRICAL ENGINEERS:** Specialists in various fields to work on fee basis. Important research organization requires outside assistance. State qualifications, specialty, background and references. P-861, Electronics, 330 W. 42nd St., New York 18, N. Y.

**WANTED — ELECTRICAL Engineers —** Sales engineer, products engineer, development and research engineer. Permanent position with established Mid-Western manufacturers with excellent post-war prospects. Attractive salary, pleasant living conditions. Unusual opportunity for advancement. Write at once, giving experience and salary expected. All replies held confidential. P-862, Electronics, 620 N. Michigan Ave., Chicago 11, Ill.

**PATENT ATTORNEY** to head patent department of a corporation engaged in the development and manufacture of electro-acoustic and electromechanical devices, and magnetic recording equipment. Experience with patent license agreements desirable. Location Ohio. P-863, Electronics, 620 N. Michigan Ave., Chicago 11, Ill.

### EMPLOYMENT SERVICE

**SALARIED POSITIONS —** This advertising service of 35 years recognized standing negotiates for high salaried supervisory technical and executive positions. Procedure will be individualized to your personal requirements and will not conflict with Manpower Commission's. Retaining fee protected by refund provision. Identity covered and present position protected. Send for details. R. W. Bixby, Inc., 278 Delward Bldg., Buffalo 2, N. Y.

### POSITIONS WANTED

**RESEARCH-PRODUCT Engineer.** Executive experience developing manufacturing and selling electronic, photographic and printing products. PW-864, Electronics, 330 W. 42nd St., New York 18, N. Y.

**CHIEF RESEARCH Engineer** (College grad.) for the last 4 years in charge of acoustic and audio development and production control with well known communications equipment manufacturer, and broad background of 13 years experience in radio research, development and production control is looking for a connection with progressive company. Happy medium between scientific accuracy and seasoned practical experience, he can be very valuable as head of development lab, and production control of middle sized company in the electronic or electro-acoustical field. Minimum salary expected \$8000.00. Excellent references available. PW-865, Electronics, 330 W. 42nd St., New York 18, N. Y.

**ELECTRICAL ENGINEER,** age 38, desires connection with firm seeking services of person as a capable project or senior engineer. Experienced by over 20 years of design and research engineering in telephone, radio and radar work. PW-866, Electronics, 330 W. 42nd St., New York 18, N. Y.

**INDUSTRIAL PHYSICIST:** With 10 years experience in electronic research and development and 4 years manager of cathode ray tube manufacturing plant desires situation in enterprising organization. PW-867, Electronics, 330 W. 42nd St., New York 18, N. Y.

### REPRESENTATIVES AVAILABLE

**ASSOCIATES COMPRISING** several radio-electronic and electrical engineers with thorough knowledge of applications in electronic and industrial field desires a few more parts lines and equipment lines to sell jobbers and manufacturers in Washington, Oregon, Montana and Idaho. Excellent sales background. If you need the services of a factory agent in the territory write Manufacturer's Sales Terminal, 222 Columbia Bldg., Spokane 8, Washington.

**MANUFACTURERS' AGENT** interested in several select lines for intensive coverage of Washington, Oregon, Montana and Idaho. 15 years electrical engineering and sales experience. Thorough knowledge of industrial and electronics equipment—want equipment lines. Write Manufacturer's Sales Terminal, 222 Columbia Building, Spokane 8, Washington.

**ENGINEER, RADIO;** E.E. and M.S. degrees; 20 years experience in radio and electronics, understands government work; desires to serve as technical representative in Southern Ohio. RA-868, Electronics, 620 N. Michigan Ave., Chicago 11, Ill.

### FOR SALE

**FOR SALE:** A large number of engineering books. Send for list. Charles F. Rodgers, 423 W. 9th St., Mount Carmel, Illinois.

(Additional Employment ads on pages 406-408)

FOR THE FIELD  
OF ELECTRONICS

# CONTACTS

FOR THE FIELD  
OF ELECTRONICS

## SOMETHING NEW!

Sleeveless type

### TUNGSTEN LEADS

PRODUCED FROM CONTINUOUS SPOLDS OF WIRE EITHER STRANDED OR SOLID, ASSURING OVERALL UNIFORMITY. EACH TINY WIRE OF THE STRANDED CABLE IS POSITIVELY FUSED TO THE TUNGSTEN.

Write for details & Samples

GLENDALE VACUUM PRODUCTS CO.

8816-77th Ave. Brooklyn 27, N. Y.



FINE RIBBONS  
OF  
TUNGSTEN and MOLYBDENUM

Quality and accuracy in our fabrication of Tungsten & Molybdenum Ribbons have characterized our service to the Electronic Industry.

A development of  
**H. CROSS CO.**  
15 Beekman St., New York 7, N. Y.

## Electron Tube Machinery

of every type,—standard, and special design

Specialists in Equipment for the manufacture of Radio Tubes, Cathode Ray Tubes, Fluorescent Lamps, Incandescent Lamps, Neon Tubes, Photo Cells, X-ray Tubes and other glass or electronic products, on production or laboratory basis.

**Kable**  
ENGINEERING COMPANY

1307-1309 Seventh St., North Bergen, N. J.

## Burned Out or Broken Electric Heating Elements



repaired with NICHRO-CITE PASTE. Simply overlap ends, apply paste, turn on current. Used by utility companies, etc. Family size, \$1.00, 4 oz. size \$2.50. Satisfaction guaranteed.

ARMSTRONG MFG. CO., Box 861 G Minneapolis, Minn.

## Strip Insulated Wires QUICKER... BETTER

with "Speedex"  
AUTOMATIC WIRE STRIPPER  
... Speeds Production

Strips insulation from all types of wire—instantly, easily, perfectly. Just press the handles and the job is done. Cuts wire too. Strips 800 to 1000 wires per hour. Available for all size solid or stranded wires—No. 8 to No. 30. List Price \$6.00. Write Dept. E for Full Particulars



**GENERAL CEMENT MFG. CO.**  
Rockford, Illinois, U.S.A.



To protect tubes and other plug-in components from loosening under vibration, get acquainted with

**BIRTCHEER LOCKING TYPE TUBE CLAMPS**

See page 398 this issue and phone, wire or write us.

**THE BIRTCHEER CORPORATION**  
Manufacturers of AIRCRAFT and RADIO PARTS  
5087 HUNTINGTON DR. LOS ANGELES 32

## BOTTLENECK REMOVER

Have you soldering problems?  
Do you use or make hermetic seals?  
Does your electro-tin plate oxidize and refuse to solder?

If so, let me help you. There is a new development in the art of hot tinning. A new development that requires no acid, no alkalin, no corrosive flux. A new development that has undreamed of possibilities.

For further information send your problem and samples, if possible, to

**DON FOSTER**  
30 BURNS AVENUE, WYOMING 15, OHIO



We manufacture a complete line of equipment

SPOT WELDERS, electric from ¼ to 50 KVA  
TRANSFORMERS, special and standard types  
INCANDESCENT LAMP manufacturing equipment  
FLUORESCENT TUBE MAKING EQUIPMENT  
ELECTRONIC EQUIPMENT, vacuum pumps, etc.  
WET GLASS slicing and cutting machines for laboratory use  
GENERAL GLASS working machines and burners  
COLLEGE GLASS working units for students and laboratory

AC ARC WELDERS  
From 100 to 400 Amps

EISLER ENGINEERING CO.  
Newark, New Jersey  
731 So. 13th St. (near Avon Ave.)



**MICROMETER FREQUENCY METER**

for checking Transmitters from 1.5 to 55 mc., within 0.01 per cent

**LAMPKIN LABORATORIES**  
Bradenton, Fla., U. S. A.

**YOUR NEW FREE CATALOG IS READY FOR YOU!**

Radionic's Catalog No. 26 lists hard-to-get radio parts • Helps you fill your radio and electronic needs. • All parts are available for immediate shipment • All are highest quality. • All are exceptional values.

SEND TODAY FOR YOUR FREE COPY TO  
Dept. 7A

**RADIONIC EQUIPMENT CO.,**  
"CHANCELLOR" PRODUCTS  
170 NASSAU STREET, NEW YORK 7, N. Y.

**MORE RF KILOWATT HOURS PER DOLLAR WITH**

**F & O TRANSMITTING TUBES**

Inquiries Invited—Let us explain how Savings are effected and the F & O greater guarantee.

**FREELAND & OLSCHNER PRODUCTS Inc.**  
611 Baronne St., New Orleans 13, La.  
Raymond 4756

High Power Tube Specialists Exclusively  
(5 KW To 100 KW)

**FREE TO RADIO MEN**



**COLOR CODE and OHMS LAW CALCULATOR**

Burstein-Applebee of Kansas City offers you this great convenience FREE. Easy to work. Solves many problems in a jiffy. FREE to radio men, electronic engineers and others in the business. Attach coupon to your letterhead.

MAIL COUPON NOW

BURSTEIN-APPLEBEE CO.  
1012 MCGEE, KANSAS CITY 6, MO.

Send me FREE Color Code and Ohms Law Calculator along with latest catalog.

I am \_\_\_\_\_  
STATE CONNECTION IN INDUSTRY

NAME \_\_\_\_\_

ADDRESS \_\_\_\_\_

TOWN \_\_\_\_\_ STATE \_\_\_\_\_

**BRAZILIAN QUARTZ CRYSTALS**

**CRYSTAL TRADING COMPANY**  
Importers

118 Liberty St. New York 6, N. Y.

If this or other advertising does not supply the information concerning products or services wanted, please write:

**ELECTRONICS.**  
New York City



**MINIATURE Precision BEARINGS**  
for precision instruments, electronic devices

RADIAL SERIES (see left) 1/8" to 5/16" outside diameter  
PIVOT SERIES 2 to 10 mm. outside diameter

For complete specifications, prices—write for catalog 431125

**MINIATURE Precision BEARINGS**  
KEENE, NEW HAMPSHIRE, U. S. A.

## **WANTED Experienced Microphone Engineer**

One of America's leading microphone organizations is looking for a capable, experienced microphone engineer.

The man we have in mind is an E. E. Graduate, thoroughly grounded in microphone theory with practical experience in microphone research, development and application.

The position is permanent and offers real opportunity to a man with ability and initiative. We are not a war-baby, but a well-established concern with definite plans. Located in a clean, midwest city of 60,000 with pleasant living conditions.

If you believe that you are the man we are looking for . . . and your record can prove it, write or call direct to our factory.

Attention: Mr. Evans

**THE TURNER CO.**  
900 17th St. N. E.  
Cedar Rapids, Iowa

## **WANTED ELECTRONICS, RADIO & MECHANICAL ENGINEERS**

An unusual opportunity is offered ambitious & capable engineers who have had qualifying experience in the design, development & preparation for manufacture of radio & industrial electronic equipment. Experienced with dielectric & induction heating equipment desirable but not essential.

Important war work now with large post war projects to follow.

**RADIO RECEPTOR CO.**  
251 W. 19 St. N. Y. 11

## **Electrolytic Capacitor Engineer**

**WANTED**

**to manage and supervise  
manufacturing**

A top opening exists for a man with real knowledge of the manufacturing of electrolytic capacitors. He may now be in charge (or acting as a key assistant) of such work. He should have full engineering knowledge of electrolytics, as well as the ability to manage people, arrange factory facilities, etc.

To such a man we offer an unparalleled opportunity for good compensation and advancement. Our present capacitor plant (now greatly enlarged and modernized) is located about 200 miles from N.Y.C. in a fine community for pleasant living. Our sales organization is strong; our future bright. Our organization has been informed of this advertisement. Write us in complete confidence and detail. An early meeting will be arranged at our expense if you have the proper qualifications.

P-857, Electronics  
330 W. 42nd St., New York 18, N. Y.

## **ENGINEERS NEEDED**

Opportunities for advancement are greater with a reputable company that is continually growing and expanding.

We need qualified engineers for permanent positions:

1. In our Radio Division, to carry on research and development of Receivers, Transmitters, Direction Finders, F-M Equipment, Broadcast & Television Receivers, and specialized Aircraft & Marine Equipment.

2. To interpret & prepare Specifications, Instruction Books, & Engineering Estimates.

3. In our Railway Signal Division, to develop and install Carrier Current Equipment.

Write for application form  
and state condition of availability.

**AIRPLANE & MARINE  
INSTRUMENTS, INC.**  
CLEARFIELD, PA.

## **Chief Engineer or Senior Engineer**

Moderate sized New York television & radio manufacturer now busy with war work but expanding very fast, which will do very substantial peacetime sales volume throughout U. S. A. and abroad, requires man with several years thorough experience in design and production of home receivers. Not a temporary, but a lifetime opportunity. To \$12,000 or more for right man.

P-869, Electronics  
330 West 42nd St., New York 18, N. Y.

## **FIELD SERVICE ENGINEERS**

**FOR DOMESTIC AND  
FOREIGN SERVICE  
and**

## **INSTRUCTORS**

**Must Possess Good  
Knowledge of Radio**

Essential workers need release

## **HAZELTINE CORPORATION**

58-25 Little Neck Parkway  
Little Neck, Long Island

## **Electrical Engineer**

Physicist, to take charge of development program involving selsyn and amplidyne controls for intricate instruments, radiation measurements, etc.

Responsible position covering urgent war work as well as post-war problems.

All inquiries held in strict confidence.

**FARRAND OPTICAL CO., INC.**  
4401 Bronx Blvd. N. Y. 66  
Att: Chief Physicist

## **WANTED Electronic Development Engineer**

To supervise the equipment layout, assembly, wiring, and testing of highly complicated electro-mechanical prototypes involving considerable electronic and telephone type of apparatus. A knowledge of airplane instruments, feed-back amplifiers and electrical servo mechanisms is desirable.

Address P. O. Box 30  
Bloomfield, New Jersey

(Additional Employment Advertising on pages 312, 344, 352, 395, 397, 399, 403 and 404)



## Radio Engineers

SEVERAL

## Electronic Engineers

for

Research & Design Dept.

EXPERIENCED

Magnetic Tape Field  
Receivers - Transmitters

Knowledge of Manufacture,  
Methods &  
Procedure Important

A REAL

Post-War Opportunity

With Fast Growing  
Progressive N. Y. Manufac-  
turer & Engineering Concern

Established over 10 years

Pioneers in  
Magnetic Recording Field

Write resume in detail

P-844, Electronics,  
330 West 42nd St., New York 18, N. Y.

## OPENINGS FOR

### RADIO ENGINEERS

### ELECTRICAL ENGINEERS

### MECHANICAL ENGINEERS

In the development and produc-  
tion of all types of radio receiv-  
ing and low-power transmitting  
tubes. Excellent post-war oppor-  
tunities with an established com-  
pany in a field having unlimited  
post-war possibilities.

Apply in person or in writing to:

Personnel Manager

## RAYTHEON

### Manufacturing Company

Radio Receiving Tube Div.

55 Chapel St., Newton, Mass.

## CHIEF ENGINEER

Thoroughly familiar with the manufacture of ca-  
pacitors, basically trained in the theory of dielec-  
trics. Should be capable of directing the activities  
in a well equipped laboratory. Electrical Engineer-  
ing or Electro-Chemical Engineering degree essen-  
tial. This is an unusual opportunity for a capable  
engineer interested in his present and postwar  
future.

P-855, Electronics  
520 North Michigan Ave., Chicago 11, Ill.

## Wanted

# ELECTRONIC ENGINEERS

We are offering permanent positions to a few Electronic Engineers or Physicists. This is an unusual opportunity for men who possess adequate educational background, originality and initiative to join a well established and growing organization engaged in research and development relating to motion picture equipment, television, and marine instruments. Write full particulars relative to education and experience, so that we can arrange an interview for you.

**INTERNATIONAL PROJECTOR CORPORATION**  
92 Gold Street  
New York 7, N. Y.

## WANTED—E. E. GRAD

### TRANSFORMER DESIGN ENGINEER

FOR ONE OF THE LEADING  
TRANSFORMER MANUFACTURERS  
in the Metropolitan Area of N. Y.

IF YOU ARE AN E. E. GRADUATE  
& interested in becoming associated  
with a company which has real  
Post-War possibilities send us a de-  
tailed resume.

P-827, Electronics  
330 West 42nd St., New York 18, N. Y.

## WANTED

### RESEARCH ENGINEERS

Prominent radio and electron-  
ics manufacturer located in  
Midwest has immediate open-  
ings for three research men  
preferably with engineering  
background, on post-war prob-  
lems in electrical and elec-  
tronic fields. Confidential in-  
quiries respected.

P-815, Electronics  
520 N. Michigan Ave., Chicago 11, Ill.

## TRANSMITTING TUBE ENGINEERS

... with actual experience in the  
design and manufacturing tech-  
niques of high vacuum and gas  
filled tube types. Excellent post  
war opportunity. Salary com-  
measurable with knowledge and  
experience in this field. Write or  
phone attention Mr. M. Youdin.

## AMPEREX

ELECTRONIC CORPORATION  
25 WASHINGTON STREET  
BROOKLYN 1, NEW YORK

## HELP WANTED

### TRANSFORMER & SMALL ELECTRIC MOTOR MEN ENGINEERS DESIGNERS DRAFTSMEN TECHNICIANS

For war time and post-war design  
and development of intricate, special-  
ized, hermetically sealed transformers,  
and special purpose fractional h.p.  
motors.

Write giving details about age, ex-  
perience, past salaries to

## SPERRY

GYROSCOPE COMPANY, INC.  
Research Laboratories  
Stewart Ave. & Clinton Rd.  
Garden City, New York

## GLASS BLOWERS

Essential war work  
& excellent post war opportunity  
Top wages & bonus  
Several years of experience required  
Newark N. J. firm  
state experience

Box 210, Suite 617, 1457 Bway, N.Y.C.

## COMMUNICATION EQUIPMENT

Technical and Production Engineers  
Required by midwest Manufacturer  
Essential War and Peace Product

P-850, Electronics  
520 N. Michigan Ave., Chicago 11, Ill.

**Alert  
Mid-Western  
Sales  
Organization  
Can Handle  
Additional Lines**

# RADIO ELECTRONICS

● This young sales organization is at present scanning the market for several additional lines of Radio and Electronic Components.

● We can promise efficient, intelligent sales representation to the manufacturer of the items we handle, that will be extremely interesting in volume.

● Our territory is large . . . covers the states of Michigan, Ohio, Indiana, Illinois, and Wisconsin. Our staff is of corresponding size so that adequate coverage is assured.

● If you produce this type of equipment — Radio or Electronics—and if you are interested in seeing real distribution of your products in this territory—write us NOW.

**B. G. TWYMAN  
AND ASSOCIATES**

8 SOUTH DEARBORN  
CHICAGO 3, ILL. STATE 5049

## Export Clients Wanted

A well-known exporter, backed by more than 15 years of experience in the electronics and allied fields, is now ready to talk to manufacturers in regard to foreign markets. We offer a complete export service, including sales representatives in practically every country in the world. We know the problems of different lands, the buying habits and preferences, the needs and potentialities. And we can show you how a tie-up between our organization and yours can be mutually profitable in the peaceful years ahead. We finance all transactions. The time is ripe for a consideration of export sales. We'll be glad to present our picture to you. Write, on your own letterhead, for complete details.

RA-858, Electronics  
330 West 42nd St., New York 18, N. Y.

## SALES ENGINEER—WEST COAST

Would like connection with progressive manufacturer of Radio and Electronic devices or components, as West Coast representative. Twenty years experience as Executive and Sales Engineer in Radio Communication, Broadcasting, Manufacturing Government and Electronic Research fields. Wide acquaintance in the industry.

SA-854, Electronics  
68 Post St., San Francisco 4, Calif.

## SALES IN CHICAGO

Established Sales and Application Engineering organization in Chicago desires to represent and additional manufacturer. If you make products of merit used by Radio, Electronic and other manufacturers as part of their assemblies our efforts can secure substantial and permanent business for you. Write for details.

RA-782, Electronics  
520 N. Michigan Ave., Chicago 11, Ill.

## WANTED SALES MANAGER

Somewhere there is a Radio Parts Salesman or Sales Engineer now working for a manufacturer's agent, Jobber, or manufacturer of radio parts who has cut his eye teeth and is ready for a bigger job.

To such a man we offer a Real Post-war opportunity, with a hard hitting aggressive organization located in N. Y. Metropolitan area. This Company will have a quality line of Transformers and test equipment to be merchandised and sold thro' the Electronic jobber. Salary and participating basis. If you have the necessary qualifications we want to hear from you. Write fully, in confidence—

SW-851, Electronics  
330 West 42nd St., New York 18, N. Y.

## SALES MANAGER

Capable of taking complete charge of Sales Department of medium size manufacturing concern. Must have a working knowledge of either condensers, resistors or transformers. Should be familiar with the electronic manufacturing or Jobbing industries. Unusual postwar opportunity. Write stating age, education, salary and previous connections.

SW-856, Electronics  
520 North Michigan Ave., Chicago 11, Ill.

## SALES MANAGER

Well established firm in East desires sales ability in field of Industrial Electronics as well as general sales for other Electronic Products. Post-war program offers unusual opportunity.

SW-828, Electronics  
330 West 42nd St., New York 18, N. Y.

## PRODUCT ENGINEERS

A progressive manufacturer of electric products needs five product engineers to do trouble shooting, shrinkage analysis, materials engineering, etc. Applicants for these positions should have a degree in either electrical engineering or physics and at least five years' engineering experience of an important nature, requiring the use of independent judgment and thorough-going analysis of electrical engineering problems. Early interviews will be arranged for qualified applicants furnishing full details regarding age, education, experience and salary requirements.

P-859, Electronics  
330 West 42nd St., New York 18, N. Y.

## WANTED ASSISTANT CHIEF ENGINEER

Mid-west radio-electronics manufacturer, engaged exclusively on electronic war projects at present, requires experienced engineer to assume complete supervision of post-war development of household and auto radio receivers. Television receiver experience desirable but not essential. All inquiries confidential. Write

P-814, Electronics  
520 N. Michigan Ave., Chicago 11, Ill.

## WANTED SENIOR DEVELOPMENT ENGINEER

Large mid-west manufacturer, now exclusively on war radio and radar work, has immediate openings for post-war radio and television development for three senior radio project engineers, two mechanical engineers and one engineer on specifications and standards. Confidential inquiries respected. Write

P-813, Electronics  
520 N. Michigan Ave., Chicago 11, Ill.

## ELECTRONIC ENGINEERS

SENIOR AND JUNIOR ENGINEERS WANTED FOR DESIGN AND DEVELOPMENT OF TEST EQUIPMENT, PRECISION WIRE WOUND RESISTORS, AND RF COILS. SHOULD HAVE PROVEN BACKGROUND IN THESE SUBJECTS.

**EASTERN ELECTRONICS  
CORP.**

41 Chestnut St. New Haven, Conn.





## WANTED

### Radio & Electronics ENGINEERS

For research and development in the field of radar, radio communications & electrical test equipment.

Good postwar opportunity.

Also openings available for  
**DRAFTSMEN &  
JUNIOR DESIGNERS**

**ALLEN D. CARDWELL MFG. CO.**  
81 Prospect St., Brooklyn

## WANTED

### INSTRUCTOR OR RESEARCH ASSOCIATE

To participate in research and teaching of physics and technology of medical instrumentation. Should be familiar with physical measuring methods, electronics and instrumentation and have interest in medical applications. Physics Ph.D. desirable. Give full professional and personal data including recent photo.

P-853, Electronics  
330 West 42nd St., New York 18, N. Y.

## WANTED

One general radio interpolation oscillator type 617C

**BEAUMONT ELECTRIC SUPPLY CO.**  
1319 S. Michigan, Chicago 5, Ill.  
Phone Wabash 6311

## BEST QUALITY, USED

### ELECTRON TUBE MACHINERY

Equipment for the manufacture of all kinds of electron tubes, radio tubes, incandescent lamps, neon tubes, photo electric cells, X-ray tubes, etc.

**AMERICAN ELECTRICAL SALES CO., INC.**  
65-67 East 8th St. New York, N. Y.

# METERS

VOLTMETERS	BRIDGES (Wheatstone)
AMMETERS	MEGOhmmeters
INDUSTRIAL	RHEOSTATS
ANALYZERS	VARIABLE
Ohmmeters	TRANSFORMERS
FREQ. METERS	RELAYS

Ask for Our Latest Availability List

## ELECTRO-TECH

EQUIPMENT COMPANY

329 Canal St., New York 13, N. Y.

# Immediate Delivery! No Priority!

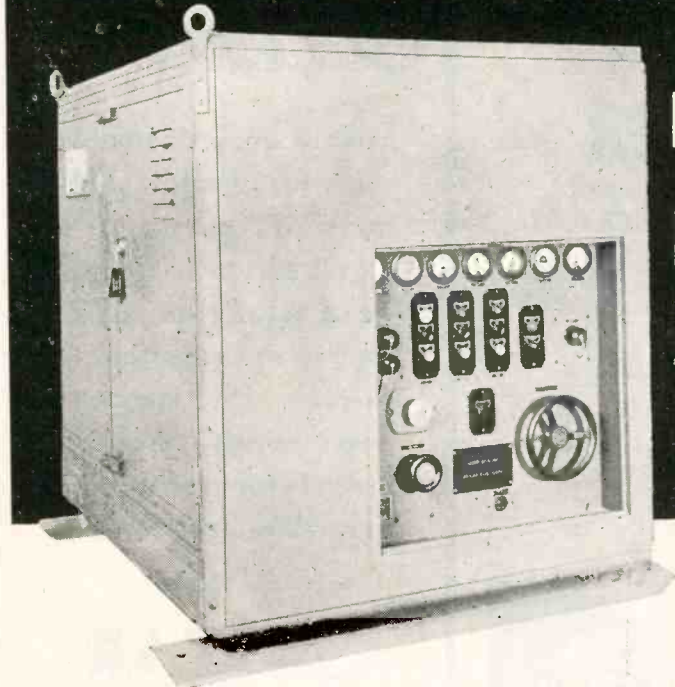

## RA-38 POWER SUPPLY

Designed to meet rigid Signal Corps specifications for mobile operation, this unit combines all the usual features found in commercial practice. Plus rugged mechanical construction necessitated by rough treatment encountered in field conditions. All component parts are conservatively rated to provide continuous duty operation, insuring trouble-free service over long periods.

Useful in a wide variety of industrial applications, these power supplies have been made available for general sale to the industry by the Reconstruction Finance Corporation's plan of selling excess stocks of government-owned electronic apparatus through recognized manufacturers of electrical equipment acting as D.S. agents.

### SPECIFICATIONS

1. Power Output continuously variable 0—15000 volts at 500 ma.—7.5 kw.
2. Ripple 1/2% at 100 ma.—3% at 500 ma.
3. Regulation 15800 V at 100 ma.—15000 V at 500 ma.  
6800 V at 100 ma.—5000 V at 500 ma.
4. Power Input 115 V 60 cycles 125 amperes at maximum output.
5. The equipment is assembled in a steel cabinet which is mounted on skids by means of rubber shock mountings.
6. The unit is 63 1/2" long, 53 3/4" wide and 56 7/8" high. Net weight complete is 2040 pounds.

*All units, completely inspected and tested by us, carry the regular manufacturer's 90 day guarantee. They are now available for immediate delivery without priority. Technical bulletins on the RA-38 Power Supply and other units of interest to electronic engineers will be forwarded on request.*

## COMMUNICATION MEASUREMENTS LABORATORY

Agent of Defense Supplies Corporation

Handling All Types of Electronic Equipment

120 GREENWICH STREET

NEW YORK 6, N. Y.

**FOR  
ELECTRONIC USE**



**SILVER**

WIRE - SHEET - TUBING  
SILVER BRAZING ALLOYS & FLUXES

**PLATINUM**

WIRE - RIBBON - FOIL  
SEAMLESS TUBING

WE INVITE INQUIRIES REGARDING ALL APPLICATIONS OF PRECIOUS METALS TO ELECTRONIC PRODUCTS.

PRECIOUS METALS



SINCE 1875

**THE  
AMERICAN PLATINUM  
WORKS**

N. J. R. R. AVE. AT OLIVER ST.  
NEWARK 5, N. J.

*Star  
Steatite*

has a very desirable low loss factor, making it particularly well suited for radio and television equipment, in addition to which its strength and density make it ideal for many mechanical uses.



**The STAR  
PORCELAIN CO.**

Electronics Dept.  
Trenton 9, N. J.

**FLEXIBLE  
SHAFTS**

for many fields

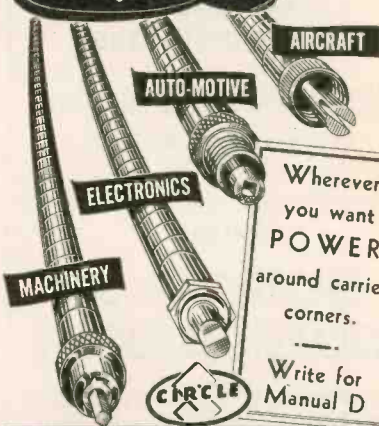

**F. W. STEWART MFG. CORP.**  
4311-13 RAVENSWOOD AVE.  
CHICAGO 13, ILL.  
WEST COAST BRANCH:  
431 Venice Blvd., Los Angeles 15, Cal.

*for Results*



**Mc Graw-Hill**  
DIRECT MAIL LIST SERVICE

**MAILING LISTS  
THAT  
WORK...**

McGraw-Hill Industrial Mailing Lists are a direct route to today's purchase-controlling executives and technicians in practically every major industry.

These names are of particular value now when most manufacturers are experiencing constantly increasing difficulty in maintaining their own lists.

Probably no other organization is as well equipped as McGraw-Hill to solve the complicated problem of list maintenance during this period of unparalleled changes in industrial personnel. These lists are compiled from exclusive sources, based on hundreds of thousands of mail questionnaires and the reports of a nation-wide field staff, and are maintained on a twenty-four hour basis.

Investigate their tremendous possibilities in relation to your own product or service. Your specifications are our guide in recommending the particular McGraw-Hill lists that best cover your market. When planning your industrial advertising and sales promotional activities, ask for more facts or, better still, write today. No obligation, of course.

**McGraw-Hill Publishing Co., Inc.**

DIRECT MAIL DIVISION

330 West 42nd Street

New York, 18, N. Y.

**TEST YOUR  
MAGNETIC CIRCUITS**

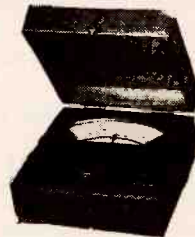

**RAWSON FLUXMETER TYPE 504**

The only portable fluxmeter available which returns rapidly to zero when a single button is depressed. Simple and fast in operation. Convenient and light in weight.

Not limited to a single type of measurement. Has universal application for laboratories or production. Measures strength of magnets and electromagnets, permeability and hysteresis loops for iron and steel, total flux lines in circuit, flux lines developed in air gap, etc.

Has a mechanical clamp to protect the pivots and jewels when in transit.

Low price \$125 net FOB Cambridge, Mass

**RAWSON ELECTRICAL  
INSTRUMENT COMPANY**

110 Potter Street, Cambridge 42, Mass.

Representatives

CHICAGO

NEW YORK CITY

# INDEX TO ADVERTISERS

	Page
Ace Manufacturing Corp.	412
Acheson-Colloids Corporation	17
Acro Electric Co.	228
Advance Electric & Relay Co.	188
Aerovox Corporation	40
Aircraft & Diesel Equipment Corp.	404
Albion Coil Co.	317
Alden Products Co.	352, 384
Allen-Bradley Co.	327
Alliance Manufacturing Co.	260
Allied Control Co., Inc.	243
Allied Radio Corp.	330
Altec Lansing Corp.	176
Aluminum Company of America	235
American Gas & Chemical Co.	401
American Lava Corporation	323
American Lens Co. Inc.	161
American Phenolic Corp.	15
American Platinum Works	410
American Screw Co.	48
American Television & Radio Co.	321
American Transformer Co.	72
Amperex Electronic Corporation	7
Amperite Co.	336
Anaconda Wire & Cable Co.	165
Andrew Co.	252
Ansonia Electric Co.	325
Armstrong Mfg. Co.	405
Arnold Engineering Co.	212
Associated Research, Inc.	395
Astatic Corporation	220
Atlantic Engineering Products	387
Atlas Tool & Designing Co.	167
Audak Co.	413
Audio Devices, Inc.	67
Auto Engraver Co.	344
Automatic Electric Sales Corp.	84
Automatic Mfg. Corporation	38
Aviometer Corporation	339
Baer Co., N. S.	318
Bakelite Corporation	237
Ballantine Laboratories, Inc.	196
Barber Laboratories, Alfred W.	348
Barker & Williamson	192
Bavner Gear Works, Inc.	296
Bell Sound Systems, Inc.	292
Bell Telephone Laboratories	20, 21
Bendix Aviation Corp., Pacific Div.	289
Bendix Aviation Corp., Radio Div.	217
Bentley, Harris Mfg. Co.	163
Benwood Linz Co.	182
Best Manufacturing Co., Inc.	262
Bircher Corporation	398, 405
Bliley Electric Co.	22
Boonton Radio Corp.	172
Brach Mfg. Corp., L. S.	286
Bradley Laboratories, Inc.	285
Brand & Co., William	253
Bridgeport Mfg. Co.	80
Buchmann Spark Wheel Corporation	370
Bud Radio, Inc.	389
Burgess Battery Co.	276
Burstein-Applebee Co.	405
Callite Tungsten Corp.	31
Cambridge Thermionic Corporation	50
Capitol Radio Engineering Institute	384
Celanese Corp. of America	265
Cellusuede Products, Inc.	286
Centralab, Div. of Globe-Union, Inc.	42
Chace Co., W. M.	326
Chicago Telephone Supply Co.	74
Chicago Transformer Corp.	377
Cinch Mfg. Corp.	145
Cinema Engineering Co.	216
Clarostat Mfg. Co., Inc.	232
Cohn & Co., Sigmund	392
Cole Steel Equipment Co.	230
Collins Radio Co.	57
Columbia Wire Supply Co.	336
Communication Measurements Laboratory	334
Communications Company, Inc.	272
Conant Electrical Laboratories	302
Concord Radio Corporation	381
Condenser Products Company	386
Connecticut Telephone & Electric Division of G. A. I.	331
Connector Div., of International Resistance Co.	273
Continental-Diamond Fibre Co.	361
Cornell-Dubilier Electric Corp.	81
Corning Glass Works	189
Cornish Wire Company, Inc.	340
Creative Plastics Corp.	176
Cross, H.	405
Crystal Trading Co.	405
Dalis, Inc., H. L.	332
Daven Company	Inside Back Cover
Dayton Rogers Mfg. Co.	320
DeJur Amsco Corporation	347
Deutschmann Corp., Tobe	2
Dial Light Co. of America, Inc.	389
Diamond Instrument Co.	301
Dobeckmun Company, The	283
Dongan Electric Mfg. Co.	399
Drake Manufacturing Co.	304
Driver-Harris Co.	59
Dumont Electric Co.	8
DuMont Laboratories, Inc., Allen B.	16, 44
du Pont de Nemours & Co. (Inc.), E. I.	41
Durez Plastics & Chemicals, Inc.	195
DX Radio Products Co.	384
Eastern Air Devices, Inc.	267
Eastern Amplifier Corporation	210
Eastern Engineering Co.	282
Eby, Inc., Hugh H.	382
Ecor, Inc.	256
Eisler Engineering Co.	344, 405
Eitel-McCullough, Inc.	89
Elco Resistors Co.	170
Elastic Stop Nut Corp. of America	73
Electric Auto-Lite Co.	46
Electrical Industries, Inc.	278
Electrical Insulation Co., Inc.	300
Electrical Reactance Corp.	391
Electrix Corporation	352
Electro-Motive Mfg. Co.	179
Electro Products Laboratories	391
Electronic Engineering Co.	282
Electronic Enterprises, Inc.	166
Electronic Measurements Co.	352
Electronic Mechanics, Inc.	70
Electronic Winding Co.	338
Erco Radio Laboratories, Inc.	374
Erie Resistor Corp.	205
Essex Electronics	411
Essex Wire Corporation	178
Fairchild Camera & Instrument Corp.	199
Federal Electric Co., Inc.	162
Federal Tel. & Radio Corp.	77, 227, 312
Fenwal, Inc.	328
Ferranti Electric, Inc.	319
Finch Telecommunications, Inc.	324
Ford Radio & Mica Corp.	324
Foredom Electric Co.	385
Formica Insulation Company	287
Foster Company, A. P.	246
Foster, Don	40
Franklin Mfg. Corp., A. W.	10
Freed Radio Corp.	399
Frceland & Olschner Products, Inc.	405
Gear Specialties	45
General Cable Corp.	24, 25
General Cement Mfg. Co.	405
General Control Co.	278
General Electric Co.	11, 12, 13, 14, 193, 241, 349, 369, 379, 395, 403
General Electronics, Inc.	175
General Industries Company	303
General Instrument Corp.	311
General Magnetic Corp.	296
General Plate Div. of Metals & Controls Corp.	333
General Radio Company	357
General Transformer Corporation	335
Giannini & Co., Inc., G. M.	397
Gibson Electric Company	378
Glaser Lead Co.	292
Glendale Vacuum Products Co.	405
Glyco Products Co., Inc.	213
Goodrich Chemical Co., B. F.	414
Gothard Manufacturing Company	282
Gould-Moody Co.	350
Gramer Company	393
Graphite Metallizing Corp.	386
Greenlee Tool Co.	403
Guardian Electric Mfg. Co.	209
Guided Radio Corporation	274
Hallcrafters Co.	39
Hammarlund Mfg. Co., Inc.	6
Handy & Harman	388
Hardwick, Hindle, Inc.	236
Harris Products Co.	322
Harvey Radio Company	390
Harvey Radio Laboratories, Inc.	151
Harvey-Wells Electronics, Inc.	309
Havdon Manufacturing Co.	393
H-B Instrument Co.	380
Heintz & Kaufman, Ltd.	35
Hermaseal Company	254
Hewlett-Packard Company	299
Hickok Electrical Instrument Co.	224
Hudson American Corp.	352, 397
Hunter Pressed Steel Co.	281
Hytron Radio & Electronics Corp.	23

ONE OF A SERIES...

**ESSEX**

Showing complete manufacturing facilities from raw material to finished product!

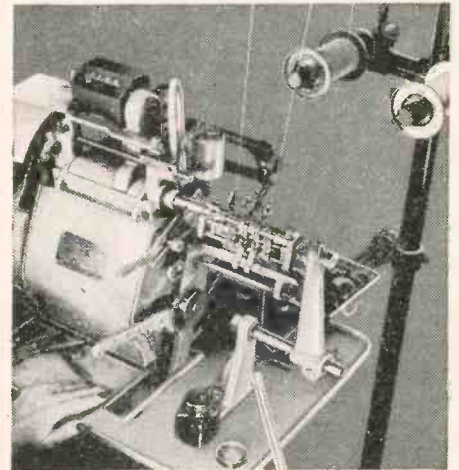

All types  
Universal  
and  
Progressive  
Windings

It takes modern machines to produce modern electronic components. ESSEX production facilities are complete for the manufacture of IF and RF coils, chokes and transformers from raw materials to finished product. Each production step is skillfully completed by experienced personnel and checked by veteran radio engineers. Modern winding machines are but a part of the equipment available at ESSEX for the producing of quality electronic components that meet the most exacting requirements of the Radio Industry.

Precision manufacturers of all types of IF and RF coils, chokes, and transformers.

**ESSEX  
ELECTRONICS**

1060 Broad St., Newark, N. J.

## PRECISION PARTS

FOR THE LONG GRIND AHEAD  
IT'S EXPERIENCE THAT COUNTS

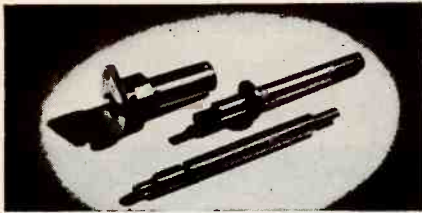

... intricate brazing-jobs made easy

When the last Jap lays down his gun, American industry will begin settling back to competitive production. No longer will it be production for production's sake. The business will go to those manufacturers who have learned a faster, better way of doing things, and who can apply their war-time lessons to the peace-time years ahead.

Grinding-out small parts by the thousands, yet holding to amazingly close tolerances, is an Ace war-time accomplishment that offers real competitive and performance advantages. Here you will find the experienced operators, the up-to-the-minute machines and equipment, and the responsibility of intelligent management to handle your parts from rough stock to finished piece.

If you have any small parts and assemblies calling for stamping, machining, heat-treating, and grinding, it will pay you to consult with Ace. Send sketch, blueprint, or sample for quotations.

### GRINDING CAPACITY NOW OPEN

The Idler-Shaft, the Rotor-Shaft, and the Clutch-Bushing shown above are typical of Ace grinding-operations. They involve internal, external, thread, and centerless grinding to .0002" tolerances. Ace makes these parts by the thousands, and a modern, well-equipped inspection department assures uniform accuracy of each piece.



**ACE MANUFACTURING CORPORATION**  
for Precision Parts



1255 E. ERIE AVENUE, PHILADELPHIA 24, PA.

# INDEX TO ADVERTISERS

Continued

	Page		Page
Illinois Condenser Co. ....	399	Pan-Electronic Laboratories, Inc. ....	280
Indiana Steel Products Co. ....	174	Par Metal Products Corporation ....	376
Industrial & Commercial Electronics .....	198	Patton-MacGuey Company ....	336
Industrial Condenser Corp. ....	204	Peerless Electrical Products Co. ....	160
Industrial Instruments ....	324	Permo, Inc. ....	348
Insl-X Co., Inc. ....	294	Permoflux Corporation ....	244
Instrument Resistors Company ....	392	Petersen Radio Co. ....	318
Insuline Corp. of America ....	391	Phillips Screw Manufacturers ....	68
International Detrola Corporation ....	295	Piezoelectric Corporation ....	328
International Resistance Co. ....	149	Pioneer Gen-E-Motor Corp. ....	184
Irrington Varnish & Insulator Co. ....	219	Plaskon Div., Libbey-Owens-Ford Glass Co. ....	293
Islip Radio Mfg. Corp. ....	403	Plastic Wire & Cable Corp. ....	279
		Plax Corporation ....	359
Jackson Electrical Instrument Co. ....	240	Polan Industries ....	247
Janette Manufacturing Co. ....	300	Pollak Manufacturing Co. ....	218
J-B-I Instruments, Inc. ....	284	Potter & Brumfield Mfg. Co., Inc. ....	316
Jefferson Electric Co. ....	27	Potter Instrument Co. ....	181
Jelliff Mfg. Corp., C. O. ....	401	Premier Metal Etching Co. ....	328
Jensen Radio Mfg. Co. ....	53	Press Wireless, Inc. ....	229
Jerome Engineering Co. ....	329	Presto Electric Co. ....	320
Johnson Co., E. F. ....	263	Presto Recording Corp. ....	28
Joliet Chemicals, Ltd. ....	313	Price Brothers Co. ....	66
Jones Co., Howard B. ....	397	Progressive Mfg. Co. ....	393
		Protectoseal Company ....	300
		Pyroferic Co. ....	312
Kaar Engineering Co. ....	43	Quadriga Mfg. Co. ....	399
Kable Engineering Co. ....	405	Quaker City Gear Works, Inc. ....	364
Karp Metal Products Co., Inc. ....	29		
Kelnor Mfg. Company ....	332	Radell Corp. ....	344
Ken-Rad ....	214	Radiart Corporation ....	187
Kester Solder Co. ....	366	Radio Condenser Co. ....	51
Keuffel & Esser Co. ....	3	Radio Corp. of America, Victor Div. ....	18, 19
Keystone Carbon Company, Inc. ....	26		32, 157, Back Cover
Kings Electronics Co. ....	372	Radio Receptor Co., Inc. ....	37
Kinney Manufacturing Company ....	200	Radio-Television Institute, Inc. ....	258
Kirkland Co., H. R. ....	340	Radio Wire Television, Inc. ....	304
Knights Co., James ....	314	Radionic Equipment Co. ....	405
Kold-Hold Mfg. Co. ....	383	Railway Express Agency ....	278
Kurman Electric Co. ....	376	Rapid Electroplating Process, Inc. ....	395
Kyle Corporation ....	185	Rauland Corporation ....	403
		Rawson Electrical Instrument Co. ....	410
Lampkin Laboratories ....	405	Raytheon Mfg. Co. ....	75, 86
Langevin Company, Inc. ....	345	Remler Company, Ltd. ....	9
Lapp Insulator Co., Inc. ....	33	Revere Copper & Brass Inc. ....	315
Lavoie Laboratories ....	291	Richardson Company, Ltd. ....	356
Lawton, Norman H. ....	340	Ripley Company, The ....	380
Lear, Inc. ....	269	Robinson Aviation, Inc. ....	159
Leland Electric Co. ....	191	Rockbestos Products Corp. ....	270
Lepl High Frequency Laboratories ....	207	Rogan Brothers ....	274
Lewis Electronics ....	375	Rogers Corporation ....	305
Lewyt Corporation ....	363	Rola Company, Inc. ....	234
Lingo & Son, Inc., John E. ....	358	Roller-Smith Co. ....	297
Littlefuse, Inc. ....	169	Russell Electric Co. ....	255
Litton Engineering Laboratories ....	173	Russell & Stoll Company ....	332
L-R Manufacturing Co. ....	380		
		Sangamo Electric Co. ....	64, 65
Makepeace Company, D. E. ....	342	Santay Corporation ....	36
Maltory & Co., Inc., P. R. ....	90, 147, 341	Schott Co., Walter L. ....	336
Marion Electrical Instrument Co. ....	63	Schweitzer Paper Co. ....	245
MB Mfg. Company, Inc. ....	337	Scientific Elec. Div. of "S" Corrugated Quenched Gap Co. ....	221
McGraw-Hill Book Co. ....	389	Scovill Mfg. Co., Electric Div. ....	367
Merit Coil & Transformer Corp. ....	180	Scovill Mfg. Co., Waterville Screw Products Div. ....	155
Mica Insulator Co. ....	4	Sealol Corporation ....	376
Micro Switch Corp. ....	56	Segel Co., Henry P. ....	401
Millen Mfg. Co., Inc., James ....	354	Selenium Corp. of America ....	396
Miniature Precision Bearings ....	405	Shallcross Mfg. Co. ....	164
Mitchell-Rand Insulation Co., Inc. ....	211	Sherman Mfg. Co., H. B. ....	308
Monsanto Chemical Co., Plastics Div. ....	215	Sherron Electronics Co. ....	55
Mossman, Inc., Donald P. ....	222	Shure Brothers ....	153
Murdock Co., Wm. J. ....	306	Sickles Company, F. W. ....	171
Mycalex Corporation of America ....	79	Sigma Instruments, Inc. ....	382
		Signal Indicator Corp. ....	316
National Carbon Co., Inc. ....	249	Silcocks-Miller Co. ....	296
National Screw & Mfg. Co. ....	177	Simpson Electric Co. ....	78
National Union Radio Corp. ....	49	Skydyne, Inc. ....	312
National Varnished Products Corp. ....	202	Skyway Precision Tool Co. ....	259
New York Transformer Co. ....	239	Small Motors, Inc. ....	400
North American Phillips Co., Inc. ....	83	Smith Mfg. Co., Inc., F. A. ....	378
Northern Communications Mfg. Co. ....	397	Snvder Mfg. Co. ....	316
		Sola Electric Co. ....	307
Ohmite Mfg. Company ....	251	Sorensen & Co. ....	266
Oiljak Manufacturing Co., Inc. ....	226	Sound Equipment Corp. of Calif. ....	388
Okonite Company ....	275	Speer Resistor Corp. ....	197
Olympic Tool & Mfg. Co., Inc. ....	390	Spencer Thermostat Company ....	353
Onan & Sons, D. W. ....	332	Spencer Wire Co. ....	71
O'Neil-Irwin Mfg. Co. ....	308	Sperti, Inc. ....	288
Oster Mfg. Co., John ....	30	Sprague Electric Co. ....	225
Oxford-Tartak Radio Corp. ....	304	Stackpole Carbon Co. ....	277
		Stamford Metal Specialty Co. ....	395
		Standard Pressed Steel Co. ....	340
		Standard Products Co. ....	233
		Standard Transformer Corp. ....	168
		Stanwyck Winding Co. ....	328
		Star Expansion Products Co. ....	398
		Star Porcelain Co. ....	410
		Stevens Walden, Inc. ....	396

	Page
Steward Mfg. Co., D. M.	348
Stewart Mfg. Corp., F. W.	410
Sticht Co., Inc., Herman H.	399
Stoelting Co., C. H.	292
Struthers-Dunn, Inc.	54
Stupakoff Ceramic & Mfg. Co.	82, 365
Sun Radio & Electronics Co.	354
Super Electric Products Corp.	88
Superior Electric Co.	242
Superior Tube Co.	76
Supreme Instruments Corp.	386
Surprenant Electrical Insulation Co.	380
Sylvania Electric Products, Inc.	62

Tech Laboratories	378
Technical Radio Company	343
Teleso Products, Inc.	360
Telex, Inc.	248
Templeton Radio Mfg. Corp.	368
Thermador Electrical Mfg. Co.	223
Thomas & Skinner Steel Products Co.	397
Thompson Corp., George S.	398
Thordarson Electric Mfg. Co.	47
Tinnerman Products, Inc.	201
Transmitter Equipment Mfg. Co., Inc.	85
Traver Corporation	261
Triplet Electrical Instrument Co.	401
Tung-Sol Lamp Works, Inc.	231

Ucinite Company	206
Union Aircraft Products Corp.	268
Union Carbide & Carbon Corp.	237, 249
United Cinephone Corporation	238
United Transformer Corp. Inside Front Cover	
University Laboratories	402
Utah Radio Products Company	61

Valpey Crystal Corp.	362
Victoreen Instrument Co.	320
Volkel Brothers Machine Works	264

Walker-Jimieson, Inc.	350
Walker-Turner Co., Inc.	298
Wallace Mfg. Co., Wm. T.	308
Waltham Screw Co.	286
Ward Leonard Electric Co.	194
Ward Products Corporation	400
Warren Telechron Co.	351
Waugh Laboratories	257
Weller Mfg. Co.	382
Western Brass Mills, Div. of Olin Industries, Inc.	69
Western Electric Co.	20, 21, 403
Westinghouse Electric Corporation	52, 69, 87, 203, 271
Weston Electrical Instrument Corp.	186
Wheeler Insulated Wire Co., Inc.	355
Whitaker Cable Corp.	183
White Dental Mfg. Co., S. S.	348, 373
Whitehead Stamping Co.	401
Wilcox Electric Co., Inc.	58
Willor Manufacturing Corp.	310
Wilson Co., H. A.	34, 190
Wincharger Corporation	394

Zenith Optical Laboratory	274
---------------------------	-----

PROFESSIONAL SERVICES	402
-----------------------	-----

SEARCHLIGHT SECTION  
(Classified Advertising)

EMPLOYMENT	404, 406, 407, 408, 409
WANTED TO PURCHASE	409
USED EQUIPMENT	
American Electric Sales Co., Inc.	409
Beaumont Elect. & Supply Co.	409
Electro-Tech Equipment Co.	409
Communications Measurements Laboratory	409

THE IMPORTANCE OF

*Specialization*

IS FORCEFULLY  
DEMONSTRATED BY

**Audax**

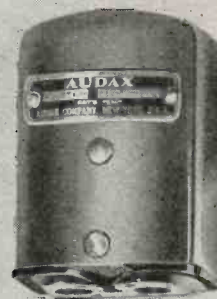

*A* side from outstanding and long-acknowledged technical skill — our “Specialization Formula” is probably as fully responsible for the world-renowned AUDAX quality as any other single factor.

We proudly concentrate all our energies and resources upon producing the finest pick-ups and cutters. Because we are specialists in this field, much more is expected of us. Because the production of fine instruments like MICRODYNE is a full time job, it stands to reason that we could not afford to jeopardize our reputation—EVER—by making pick-ups a side-line.

After Victory, you may expect further AUDAX improvements, refinements . . . master-touches to heighten the marvelous *fac simile* realism of AUDAX reproduction.

**AUDAX COMPANY**

500E Fifth Avenue, New York 18

“Creators of Fine Electronic-Acoustical Apparatus since 1915”

*“The Standard  
by Which Others  
Are Judged and Valued”*



Send for complimentary copy of our informative  
**“PICK-UP FACTS”**

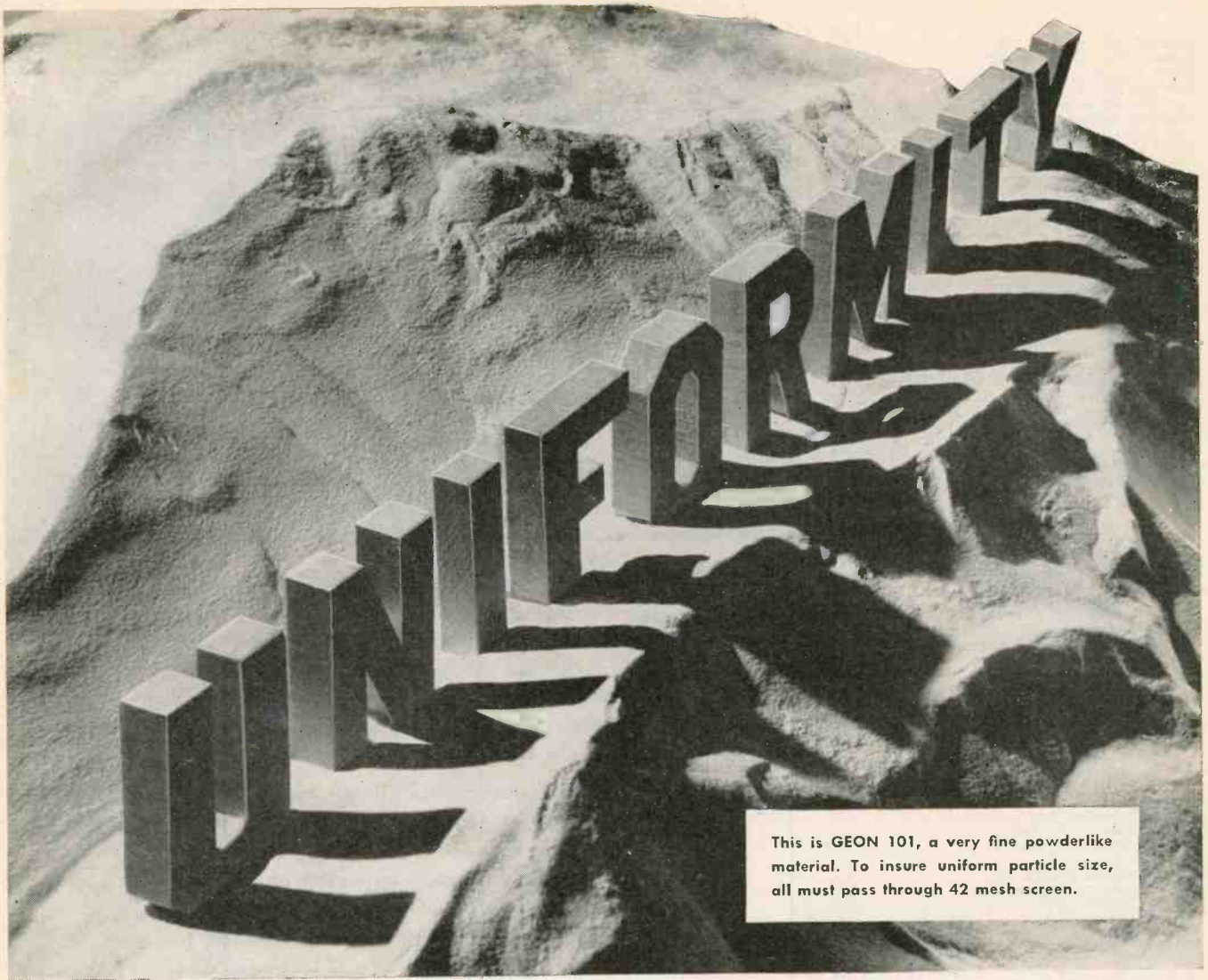

This is GEON 101, a very fine powderlike material. To insure uniform particle size, all must pass through 42 mesh screen.

## *An important advantage offered by GEON polyvinyl resins for electric wire and cable insulation*

**N**EW users of GEON polyvinyl materials are invariably delighted to discover that these resins provide definite processing advantages resulting directly from the *uniformity* of the raw material. This basic uniformity means that foot after foot, mile after mile of wire insulation made from GEON will be of continuous high quality.

With GEON resins it isn't necessary to mix several batches together in an effort to get uniformity in the base material. Nor is there any need to adjust processing machinery frequently to compensate for batch-to-batch variations of the plasticized product. The formula used yesterday with one batch of GEON can be used today and tomorrow with new batches. And the finished insulation will be uniform—electrical and all other properties always the same. That means satisfied customers, fewer rejects.



All this is true because manufacturing methods for GEON result in a material that is *uniform*—batch after batch after batch are all alike within close tolerances controlled by rigid specifications. For example, specific viscosity limits for GEON 101 are .52—.57. To control particle size, 100% must pass through 42 mesh screen.

Another important advantage of GEON is that the right *combination* of properties for your insulating material can be selected to meet the specific conditions of end use. These properties include resistance to water, heat, cold, aging, wear, abrasion, sunlight, chemicals, and many other normally destructive factors. For more information write Department FF-7, B. F. Goodrich Chemical Company, Rose Building, Cleveland 15, Ohio.

# **B. F. Goodrich Chemical Company**

A DIVISION OF  
THE B. F. GOODRICH COMPANY

# 4 Precision Switches

## ATTENUATOR COMBINED with SWITCHING DEVICE:

Application of rigid rotor with two pairs of spring-button type contacts.\* Supplied as shown with terminals wired.

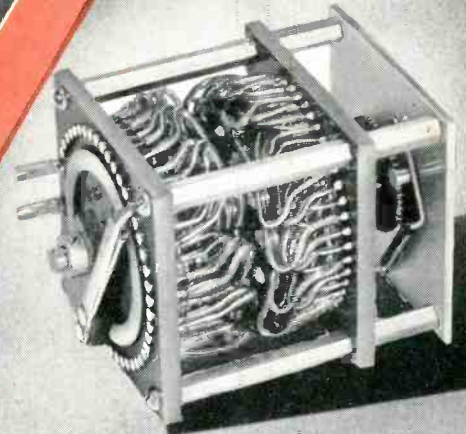
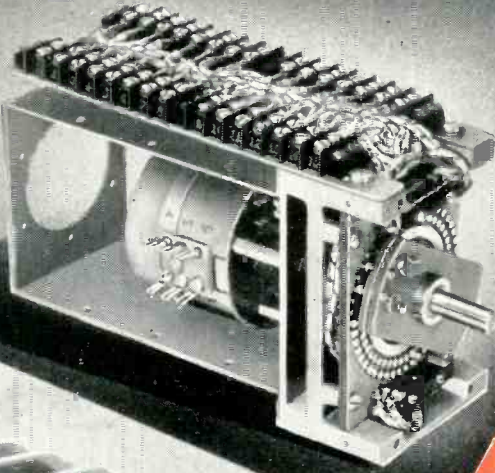

## DUAL-POTENTIOMETER:

40 steps per deck; compact back-to-back type assembly. 40 precision wire-wound resistors, mounted on each deck.

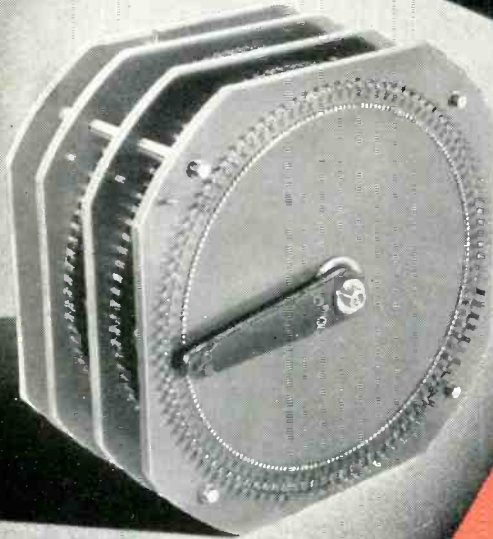

## SWITCH:

3 pole, 3 deck, 100 position, break-before-make. 200 contacts, 101 solder lugs per deck. This unit employs a newly designed switch rotor with spring-button type contacts.\*



## SWITCH:

10 pole, 3 deck, 4 position, break-before-make. Total of 52 lines wired to adaptor base. Illustrated is a stripped, wired and enclosed view.

© PATENT APPLIED FOR

Engineered by **DAVEN**  
FEATURING LOW AND UNIFORM CONTACT RESISTANCE

The four precision controls illustrated are but a few of the DAVEN-engineered switches now filling important war assignments. Each unit represents the skilled adaptation of basic DAVEN techniques to the problems of the specific application. The distinct advantage of this method of engineering switches is the assurance of a result ideally suited for the

job, plus important savings in time and cost of development. DAVEN-engineered switches are built in a wide range of sizes, of many types of materials, with varied numbers and arrangements of poles, positions, decks and terminals, in shorting and non-shorting types. A DAVEN engineer will gladly work with you on your switch problems.

KEEP BUYING WAR BONDS

THE **DAVEN** COMPANY  
191 CENTRAL AVENUE  
NEWARK 4, NEW JERSEY

DON'T LET UP NOW

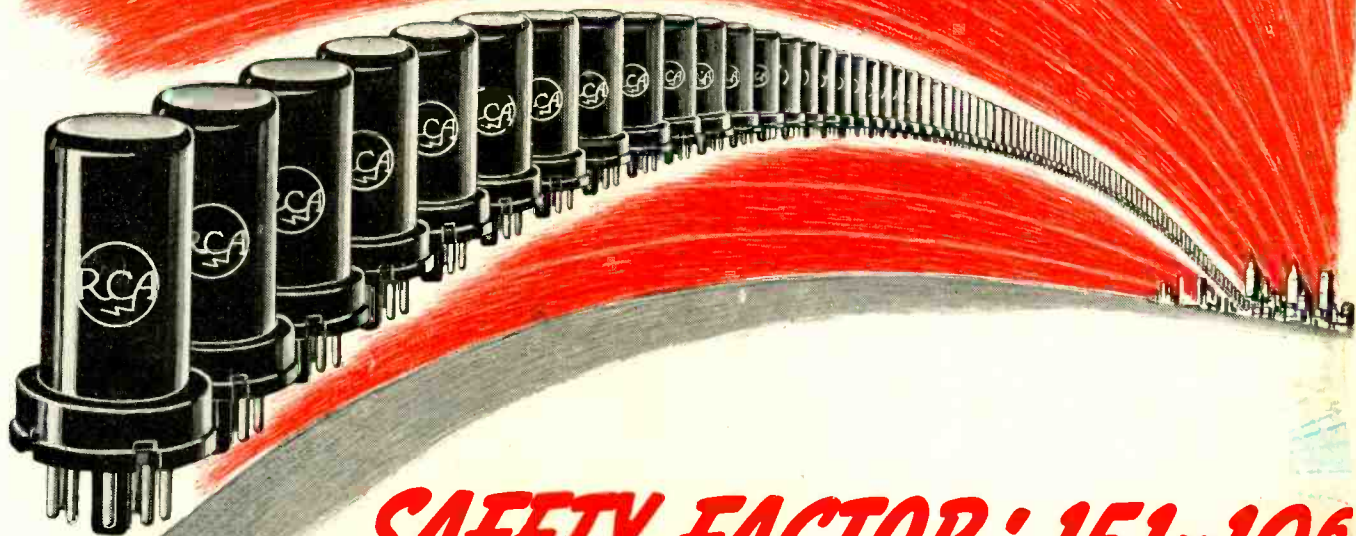

## ***SAFETY FACTOR: 151x10<sup>6</sup>***

Behind every RCA metal tube stands a big safety factor—ten years of cumulative experience gained from building more than 151,000,000 metal tubes—enough to reach from New York City to Tokyo!

**W**HEN you specify RCA metal tubes in your equipment designs, you are specifying more than tubes—you are specifying ten years of engineering and manufacturing experience.

Each of the millions of metal receiving tubes we have built has contributed to the experience of our engineers, and to the skill of our workers and production technicians.

An example of RCA's untiring effort to build better tubes at lower prices is the famous RCA Preferred-Type Program (applied to metal, glass, and miniature receiving tubes), which, in a single year, brought about an average reduction of 13% in the cost of receiving-tube types included in the program.

The idea behind the Preferred-Type Program was to concentrate production on fewer types, making possible longer manufacturing runs, which, in turn, would increase production efficiency and reduce costs.

The preferences of RCA customers determined which tubes were to be included in the Preferred-Type Program.

**THE FOUNTAINHEAD OF MODERN TUBE  
DEVELOPMENT IS RCA**

In 1940, 80% of all metal tubes manufactured by RCA were *preferred* types. Of the 151-million metal tubes manufactured by RCA since 1935, nearly 40% have been *preferred* types.

Look to RCA, postwar, for your metal-tube requirements. If you already have specific tube complements in mind for your postwar equipment, why not check with RCA *now* to make sure that the tubes you intend using shall be included in the postwar RCA Preferred-Type Program. Remember, it is *you*, not RCA, who decides which types are to be *preferred* types. Write, listing your tube types, to RCA, Commercial Engineering Department, Section 62-40e, Harrison, N. J.

BUY WAR BONDS



62-6136-40

**RADIO CORPORATION OF AMERICA**

RCA VICTOR DIVISION • CAMDEN, N. J.